

Service and Troubleshooting

ANX, SSX, ASX, GSX, DSX, VSX Condensing Units, ANZ, SSZ, ASZ, GSZ, DSZ, VSZ Split System Heat Pumps GSXH5, ASXH5,GSZH5, ASZH5, With R-410A Refrigerant Blowers, Coils, & Accessories

Pride and workmanship go into every product to provide our customers with quality products. It is possible, however, that during its lifetime a product may require service. Products should be serviced only by a qualified service technician who is familiar with the safety procedures required in the repair and who is equipped with the proper tools, parts, testing instruments and the appropriate service manual. **REVIEW ALL SERVICE INFORMATION IN THE APPROPRIATE SERVICE MANUAL BEFORE BEGINNING REPAIRS.**

For service information related to the Bluetooth® Shared Data Loader BTSDL01 referenced in this manual, please refer to the installation instructions for the BTSDL01 at www.coolcloudhvac.com/loaderuserguide.



WARNING

ONLY PERSONNEL THAT HAVE BEEN TRAINED TO INSTALL, ADJUST, SERVICE, MAINTENANCE OR REPAIR (HEREINAFTER, "SERVICE") THE EQUIPMENT SPECIFIED IN THIS MANUAL SHOULD SERVICE THE EQUIPMENT.

THIS EQUIPMENT IS NOT INTENDED FOR USE BY PERSONS (INCLUDING CHILDREN) WITH REDUCED PHYSICAL, SENSORY OR MENTAL CAPABILITIES, OR LACK OF EXPERIENCE AND KNOWLEDGE, UNLESS THEY HAVE BEEN GIVEN SUPERVISION OR INSTRUCTION CONCERNING USE OF THE APPLIANCE BY A PERSON RESPONSIBLE FOR THEIR SAFETY.

CHILDREN SHOULD BE SUPERVISED TO ENSURE THAT THEY DO NOT PLAY WITH THE EQUIPMENT.

THE MANUFACTURER WILL NOT BE RESPONSIBLE FOR ANY INJURY OR PROPERTY DAMAGE ARISING FROM IMPROPER SUPERVISION, SERVICE OR SERVICE PROCEDURES. IF YOU SERVICE THIS UNIT, YOU ASSUME RESPONSIBILITY FOR ANY INJURY OR PROPERTY DAMAGE WHICH MAY RESULT. IN ADDITION, IN JURISDICTIONS THAT REQUIRE ONE OR MORE LICENSES TO SERVICE THE EQUIPMENT SPECIFIED IN THIS MANUAL, ONLY LICENSED PERSONNEL SHOULD SERVICE THE EQUIPMENT. IMPROPER SUPERVISION, INSTALLATION, ADJUSTMENT, SERVICING, MAINTENANCE OR REPAIR OF THE EQUIPMENT SPECIFIED IN THIS MANUAL, OR ATTEMPTING TO INSTALL, ADJUST, SERVICE OR REPAIR THE EQUIPMENT SPECIFIED IN THIS MANUAL WITHOUT PROPER SUPERVISION OR TRAINING MAY RESULT IN PRODUCT DAMAGE, PROPERTY DAMAGE, PERSONAL INJURY OR DEATH.



WARNING

DO NOT BYPASS SAFETY DEVICES.



IMPORTANT INFORMATION

TABLE OF CONTENTS



IMPORTANT INFORMATION	2	CHECKING HEATER ELEMENTS	94
PRODUCT IDENTIFICATION	4	REFRIGERATION REPAIR PRACTICE	94
PRODUCT DESIGN	56	STANDING PRESSURE TEST	95
SYSTEM OPERATION	59	LEAK TESTING	
SERVICING	69	(NITROGEN OR NITROGEN-TRACED).....	95
CHECKING VOLTAGE	69	SYSTEM EVACUATION	95
CHECKING WIRING	69	DEEP VACUUM METHOD (RECOMMENDED)	95
CHECKING THERMOSTAT AND WIRING	69	TRIPLE EVACUATION METHOD (ALTERNATE)	96
THERMOSTAT WIRING	69	CHARGING	96
CHECKING TRANSFORMER AND CONTROL		FINAL CHARGE ADJUSTMENT	97
CIRCUIT	70	CHECKING COMPRESSOR EFFICIENCY	98
CHECKING CONTACTOR AND/OR RELAYS	70	OVERFEEDING	98
CHECKING CONTACTOR CONTACTS.....	70	UNDERFEEDING.....	98
CHECKING FAN RELAY CONTACTS.....	71	CHECKING SUPERHEAT	98
CHECKING LOSS OF CHARGE PROTECTOR		SUBCOOLING ON EXPANSION VALVE SYSTEM.....	99
(HEAT PUMP MODELS)	72	CHECKING EXPANSION VALVE OPERATION.....	99
CHECKING HIGH PRESSURE CONTROL	72	CHECKING RESTRICTED LIQUID LINE.....	100
CHECKING LOW PRESSURE CONTROL.....	72	OVERCHARGE OF REFRIGERANT	100
COPELAND COMFORT ALERT™ DIAGNOSTICS -		NON-CONDENSABLES	100
3-WIRE MODULE	73	COMPRESSOR BURNOUT.....	100
COPELAND CORESENSE™ DIAGNOSTICS -		REFRIGERANT PIPING.....	103
3-WIRE MODULE.....	73	DUCT STATIC PRESSURES	103
CHECKING CAPACITOR.....	79	SINGLE PIECE AIR HANDLER	
RESISTANCE CHECK USING A DIGITAL		EXTERNAL STATIC	103
MULTI-METER	79	TWO PIECE AIR HANDLER EXTERNAL STATIC	
CAPACITANCE CHECK USING A DIGITAL		PRESSURE.....	104
MULTI-METER (IN CAPACITANCE MODE)	79	FURNACE EXTERNAL STATIC PRESSURE	104
TESTING A RUN CAPACITOR UNDER LOAD.....	79	PERIODIC MAINTENANCE	104
CHECKING OUTDOOR FAN AND BLOWER		WIRING DIAGRAMS	114
MOTORS (PSC MOTORS)	79		
CHECKING FAN AND BLOWER MOTOR			
(ECM MOTORS)	79		
CHECKING ECM MOTOR WINDINGS.....	81		
ECM CFM ADJUSTMENTS MBE/AEPF	81		
BLOWER PERFORMANCE DATA	86		
CHECKING HIGH EFFICIENCY MOTORS	86		
EEM BLOWER REPLACEMENT	87		
MBR/AR*F ELECTRONIC BLOWER TIME DELAY			
RELAY	88		
CHECKING COMPRESSOR.....	88		
RESISTANCE TEST.....	89		
GROUND TEST	89		
UNLOADER TEST PROCEDURE	90		
OPERATION TEST.....	90		
CHECKING 3-PHASE SCROLL COMPRESSOR			
ROTATION	91		
TESTING CRANKCASE HEATER			
(OPTIONAL ITEM)	91		
CHECKING REVERSING VALVE AND SOLENOID	91		
TESTING DEFROST CONTROL	92		
TESTING DEFROST THERMOSTAT.....	92		
CHECKING HEATER LIMIT CONTROL(S).....	92		
CHECKING HEATER ELEMENTS.....	93		
ELECTRIC HEATER (OPTIONAL ITEM)	93		
CHECKING HEATER LIMIT CONTROL(S).....	94		

IMPORTANT INFORMATION

IMPORTANT NOTICES

RECOGNIZE SAFETY SYMBOLS, WORDS AND LABELS

 WARNING
TO PREVENT THE RISK OF PROPERTY DAMAGE, PERSONAL INJURY, OF DEATH, DO NOT STORE COMBUSTIBLE MATERIALS OR USE GASOLINE OR OTHER FLAMMABLE LIQUIDS OR VAPORS IN THE VICINITY OF THIS APPLIANCE.

 WARNING
HIGH VOLTAGE DISCONNECT ALL POWER BEFORE SERVICING OR INSTALLING THIS UNIT. MULTIPLE POWER SOURCES MAY BE PRESENT. FAILURE TO DO SO MAY CAUSE PROPERTY DAMAGE, PERSONAL INJURY OR DEATH.

 WARNING
THIS UNIT SHOULD NOT BE CONNECTED TO, OR USED IN CONJUNCTION WITH, ANY DEVICES THAT ARE NOT DESIGN CERTIFIED FOR USE WITH THIS UNIT OR HAVE NOT BEEN TESTED AND APPROVED BY THE MANUFACTURER. SERIOUS PROPERTY DAMAGE OR PERSONAL INJURY, REDUCED UNIT PERFORMANCE AND/OR HAZARDOUS CONDITIONS MAY RESULT FROM THE USE OF DEVICES THAT HAVE NOT BEEN APPROVED OR CERTIFIED BY THE MANUFACTURER.

SAFE REFRIGERANT HANDLING

While these items will not cover every conceivable situation, they should serve as a useful guide.

 WARNING
REFRIGERANTS ARE HEAVIER THAN AIR. THEY CAN "PUSH OUT" THE OXYGEN IN YOUR LUNGS OR IN ANY ENCLOSED SPACE. TO AVOID POSSIBLE DIFFICULTY IN BREATHING OR DEATH: <ul style="list-style-type: none">• NEVER PURGE REFRIGERANT INTO AN ENCLOSED ROOM OR SPACE. BY LAW, ALL REFRIGERANT MUST BE RECLAIMED.• IF AN INDOOR LEAK IS SUSPECTED, THOROUGHLY VENTILATE THE AREA BEFORE BEGINNING WORK.• LIQUID REFRIGERANT CAN BE VERY COLD. TO AVOID POSSIBLE FROSTBITE OR BLINDNESS, AVOID CONTACT WITH REFRIGERANT AND WEAR GLOVES AND GOGGLES. IF LIQUID REFRIGERANT DOES CONTACT YOUR SKIN OR EYES, SEEK MEDICAL HELP IMMEDIATELY.• ALWAYS FOLLOW EPA REGULATIONS. NEVER BURN REFRIGERANT, AS POISONOUS GAS WILL BE PRODUCED.

 WARNING
TO AVOID POSSIBLE INJURY, EXPLOSION OR DEATH, PRACTICE SAFE HANDLING OF REFRIGERANTS.

 WARNING
THE COMPRESSOR POE OIL FOR R-410A UNITS IS EXTREMELY SUSCEPTIBLE TO MOISTURE ABSORPTION AND COULD CAUSE COMPRESSOR FAILURE. DO NOT LEAVE SYSTEM OPEN TO ATMOSPHERE ANY LONGER THAN NECESSARY FOR INSTALLATION.

 WARNING
TO AVOID POSSIBLE EXPLOSION: <ul style="list-style-type: none">• NEVER APPLY FLAME OR STEAM TO A REFRIGERANT CYLINDER. IF YOU MUST HEAT A CYLINDER FOR FASTER CHARGING, PARTIALLY IMMERSE IT IN WARM WATER.• NEVER FILL A CYLINDER MORE THAN 80% FULL OF LIQUID REFRIGERANT.• NEVER ADD ANYTHING OTHER THAN R-22 TO AN R-22 CYLINDER OR R-410A TO AN R-410A CYLINDER. THE SERVICE EQUIPMENT USED MUST BE LISTED OR CERTIFIED FOR THE TYPE OF REFRIGERANT USED.• STORE CYLINDERS IN A COOL, DRY PLACE. NEVER USE A CYLINDER AS A PLATFORM OR A ROLLER.

 WARNING
TO AVOID POSSIBLE EXPLOSION, USE ONLY RETURNABLE (NOT DISPOSABLE) SERVICE CYLINDERS WHEN REMOVING REFRIGERANT FROM A SYSTEM. <ul style="list-style-type: none">• ENSURE THE CYLINDER IS FREE OF DAMAGE WHICH COULD LEAD TO A LEAK OR EXPLOSION.• ENSURE THE HYDROSTATIC TEST DATE DOES NOT EXCEED 5 YEARS. ENSURE THE PRESSURE RATING MEETS OR EXCEEDS 400 LBS. WHEN IN DOUBT, DO NOT USE CYLINDER.

OUTSIDE THE U.S., call 1-713-861-2500.
(Not a technical assistance line for dealers.) Your telephone company will bill you for the call.

PRODUCT IDENTIFICATION

NOMENCLATURE

The model and manufacturing number are used for positive identification of component parts used in manufacturing. Please use these numbers when requesting service or parts information.

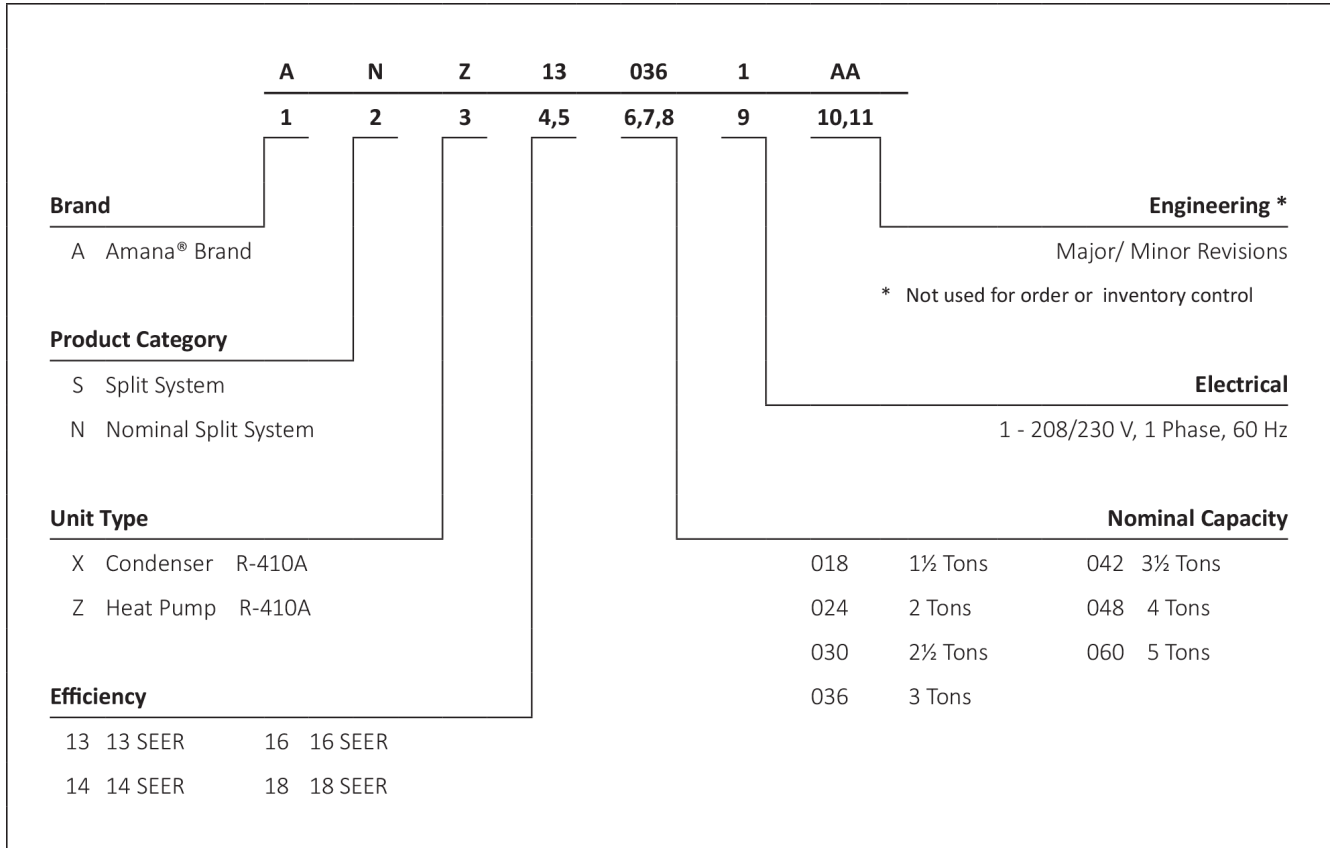

OUTDOOR UNITS

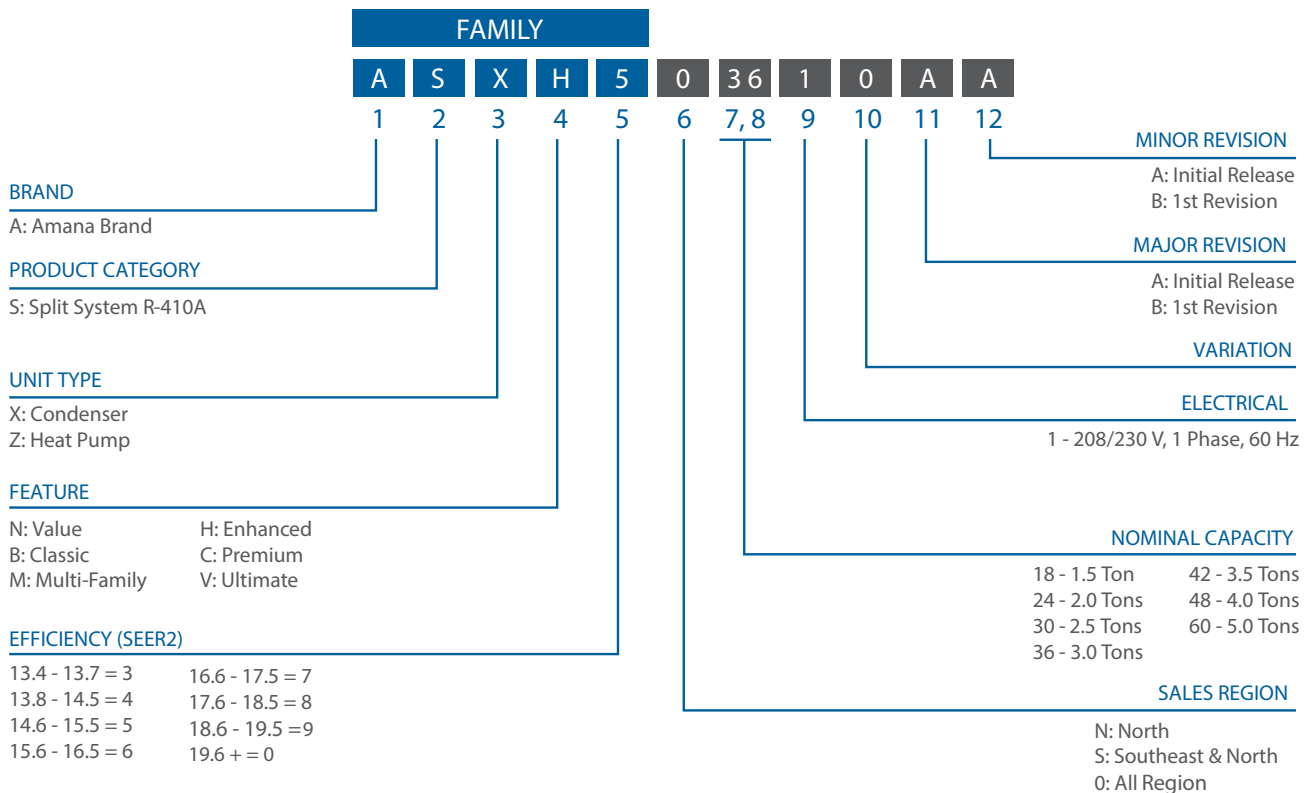

PRODUCT IDENTIFICATION

NOMENCLATURE

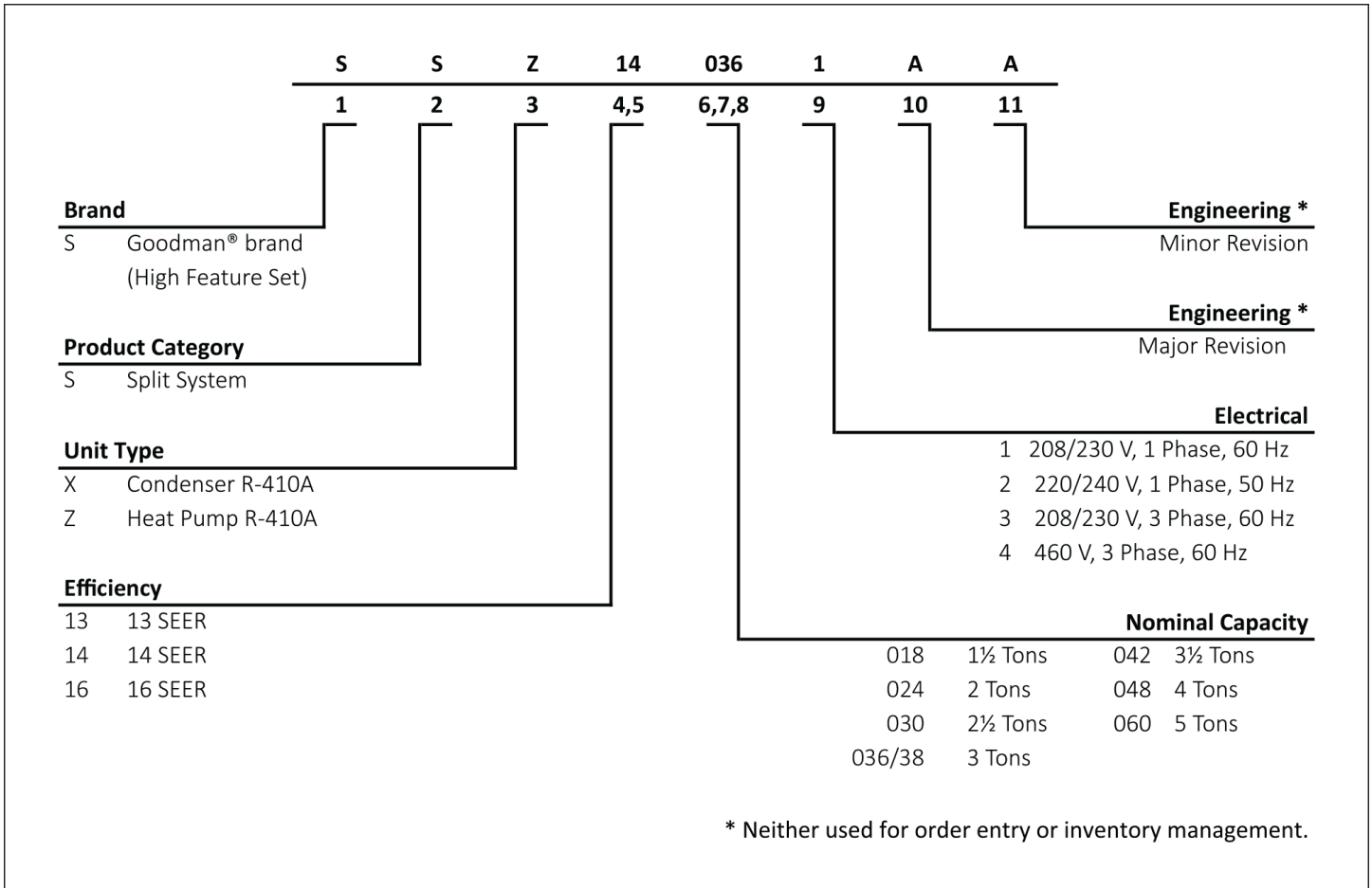

PRODUCT IDENTIFICATION

NOMENCLATURE

	V	S	X	13	036	1	AA		
	1	2	3	4,5	6,7,8	9	10,11		
Brand	V GMC® Brand						Engineering *		Major & Minor revisions * Not used for inventory control.
Product Category	S Split System						Electrical		1- 208/230 V, 1 Phase, 60 Hz
Unit Type	X Condenser R-410A Z Heat Pump R-410A						Nominal Capacity		018- 1½ tons 036- 3 tons 060 5 Tons 024- 2 tons 042 3½ Tons 061 5 Tons 030- 2½ tons 048 4 Tons (high capacity)
Efficiency	13 13 SEER 16 16 SEER 14 14 SEER 18 18 SEER								

PRODUCT IDENTIFICATION

NOMENCLATURE

	G	S	X	H	5	0	36	1	0	**				
	1	2	3	4	5	6	7,8	9	10	11,12				
Brand	G - Goodman® Brand											Engineering		
Product Category	S Split System R-410A											Major/Minor Revisions A - Initial Release B - 1st Revision		
Unit Type	X Condenser Z Heat Pump											Variation		
Feature	N Value B Classic M Multi-Family		H Enhanced C Premium V Ultimate											Electrical
SEER2	13.4 - 13.7 = 3 13.8 - 14.5 = 4 14.6 - 15.5 = 5 15.6 - 16.5 = 6		16.6 - 17.5 = 7 17.6 - 18.5 = 8 18.6 - 19.5 = 9 19.6 + = 0											Nominal Capacity
														1 208/230 V, 1 Phase, 60 Hz
														18 - 1.5 Ton 24 - 2.0 Tons 30 - 2.5 Tons 36 - 3.0 Tons
														42 - 3.5 Tons 48 - 4.0 Tons 60 - 5.0 Tons
														Sales Region
														N North S Southeast & North O All Regions

PRODUCT IDENTIFICATION

NOMENCLATURE

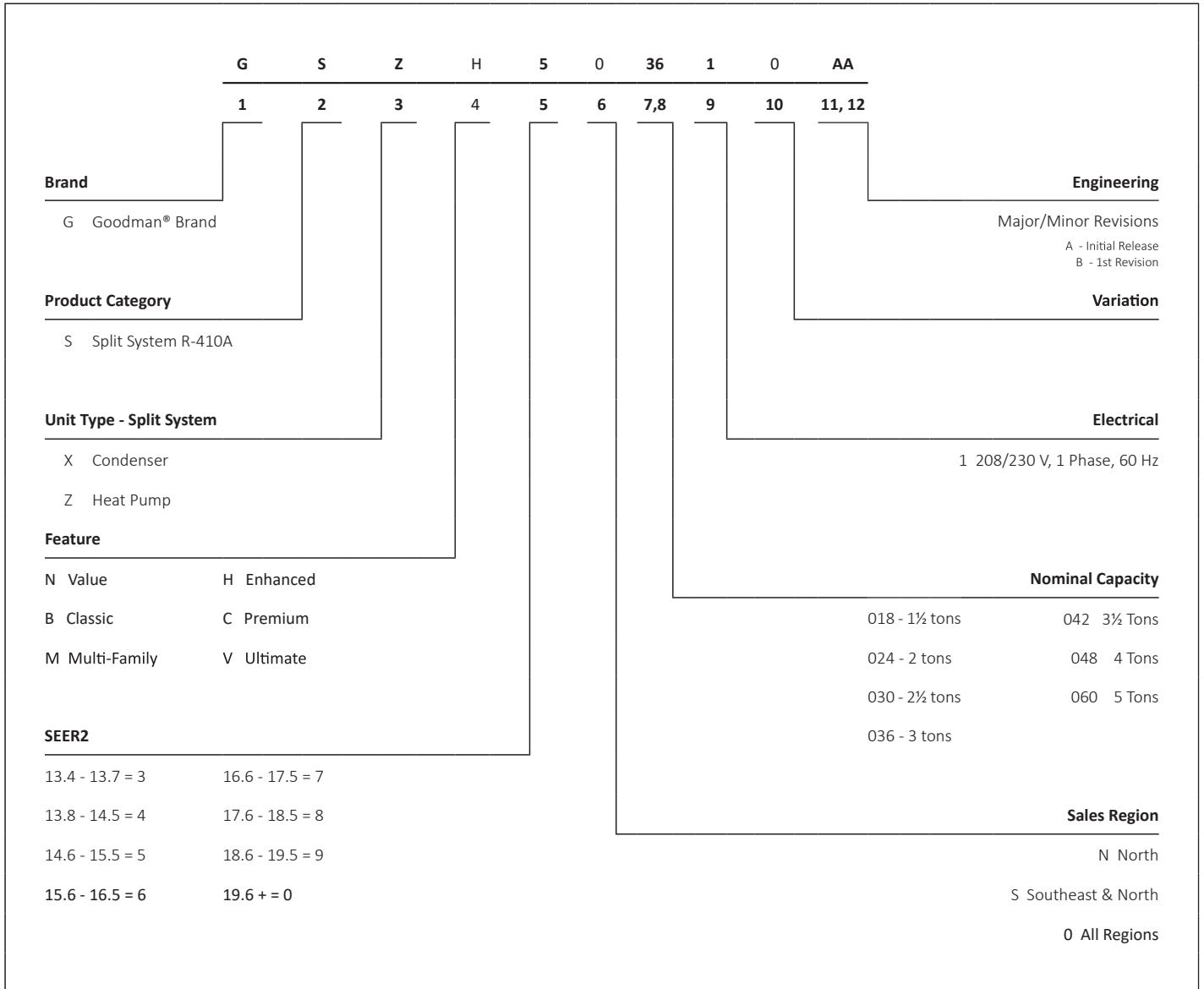

PRODUCT IDENTIFICATION

NOMENCLATURE

	C	A	U	F	1824	A	6	AA	
	1	2	3	4	5,6,7,8	9	10	11,12	
Product Category									Engineering
C- Indoor Coil									Major/Minor Revisions
Application									Refrigerant
A- Upflow/Downflow Coil									6- R-22 / R-410A
H- Horizontal A Coil									2- R-22
S- Horizontal Slab Coil									4- R-410A
Cabinet Finish									Nominal Width for Gas Furnace
U- Uncased C- Unpainted									A- Fits 14" Furnace Cabinet
P- Painted									B- Fits 17½" Furnace Cabinet
									C- Fits 21" Furnace Cabinet
Expansion Device									N- Does Not Apply (horizontal slab coil)
F- Flowrator									
T- TXV									
									Nominal Capacity Range @ 13 SEER
									1824- 1½ to 2 Tons 3642- 3 to 3½ Tons
									3030- 2½ Tons 3743- 3 to 3½ Tons
									3131- 2½ Tons 4860- 4 to 5 Tons
									3137- 2 ½ to 3 Tons 4961- 4 to 5 Tons
									3636- 3 Tons

PRODUCT IDENTIFICATION

NOMENCLATURE



C A P F A 1 8 1 4 A 6 A A
1 2 3 4 5 6 7 8 9 10 11 12 13

Product Category

C Indoor Coil

Application

A Upflow/Downflow

H Horizontal

Cabinet Finish

U Uncased

P Cased- Painted

C Cased- Unpainted

Expansion Device

F Flowrater

T TXV

E Electronic Expansion Device

Coil Configuration

A A Coil

S Slab

Engineering

Major/ Minor Revisions

Refrigerant

2- R-22 only

4- R-410A only

6- R-22 or R-410A compatible

Nominal Width for Gas Furnace

A- 14" Width

D- 24.5" Width

B- 17.5" Width

N- Not Applicable (Slab Coil)

C- 21" Width

Cased Height

14- 14" Coil

22- 22" Coil

18- 18" Coil

26- 26" Coil

30- 30" Coil

Nominal Capacity Range

17, 18- 1.5 Tons

29, 30- 2.5 Tons

42- 3.5 Tons

60- 5 Tons

23, 24- 2 Tons

35, 36- 3 Tons

48- 4 Tons

PRODUCT IDENTIFICATION

NOMENCLATURE

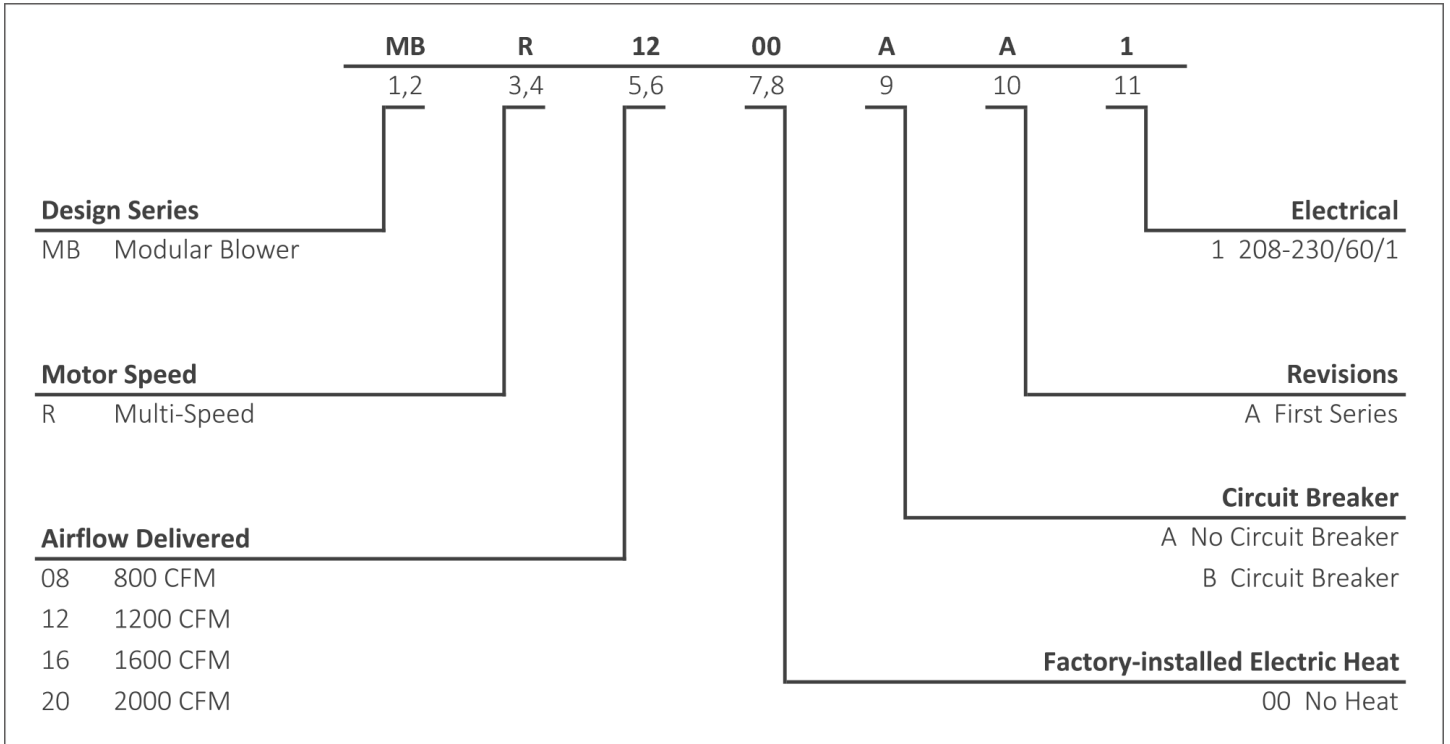

PRODUCT IDENTIFICATION

NOMENCLATURE

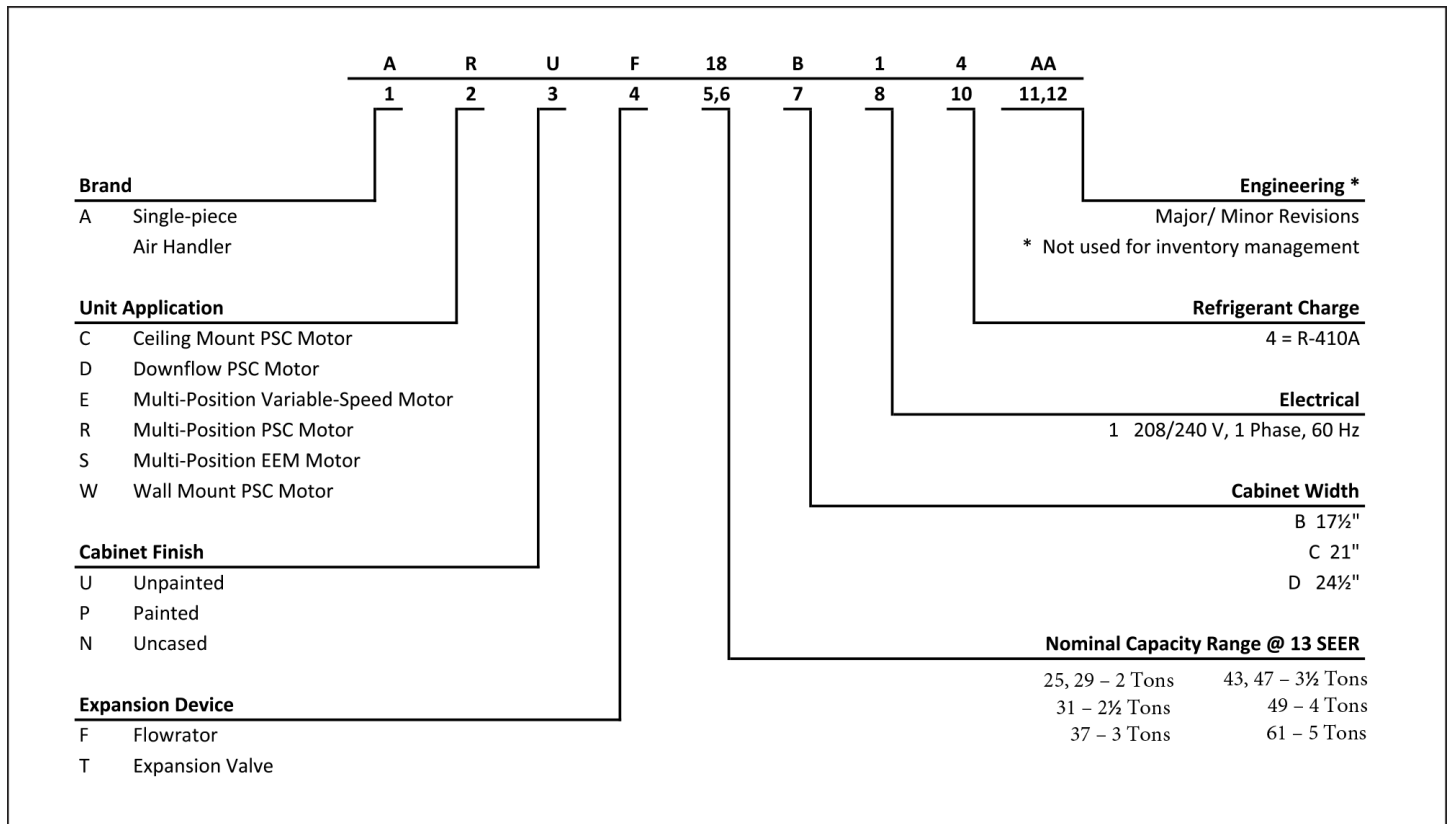

All Airhandlers use **DIRECT DRIVE MOTORS**. Power supply is AC 208-240v, 60 hz, 1 phase.

PRODUCT IDENTIFICATION

NOMENCLATURE

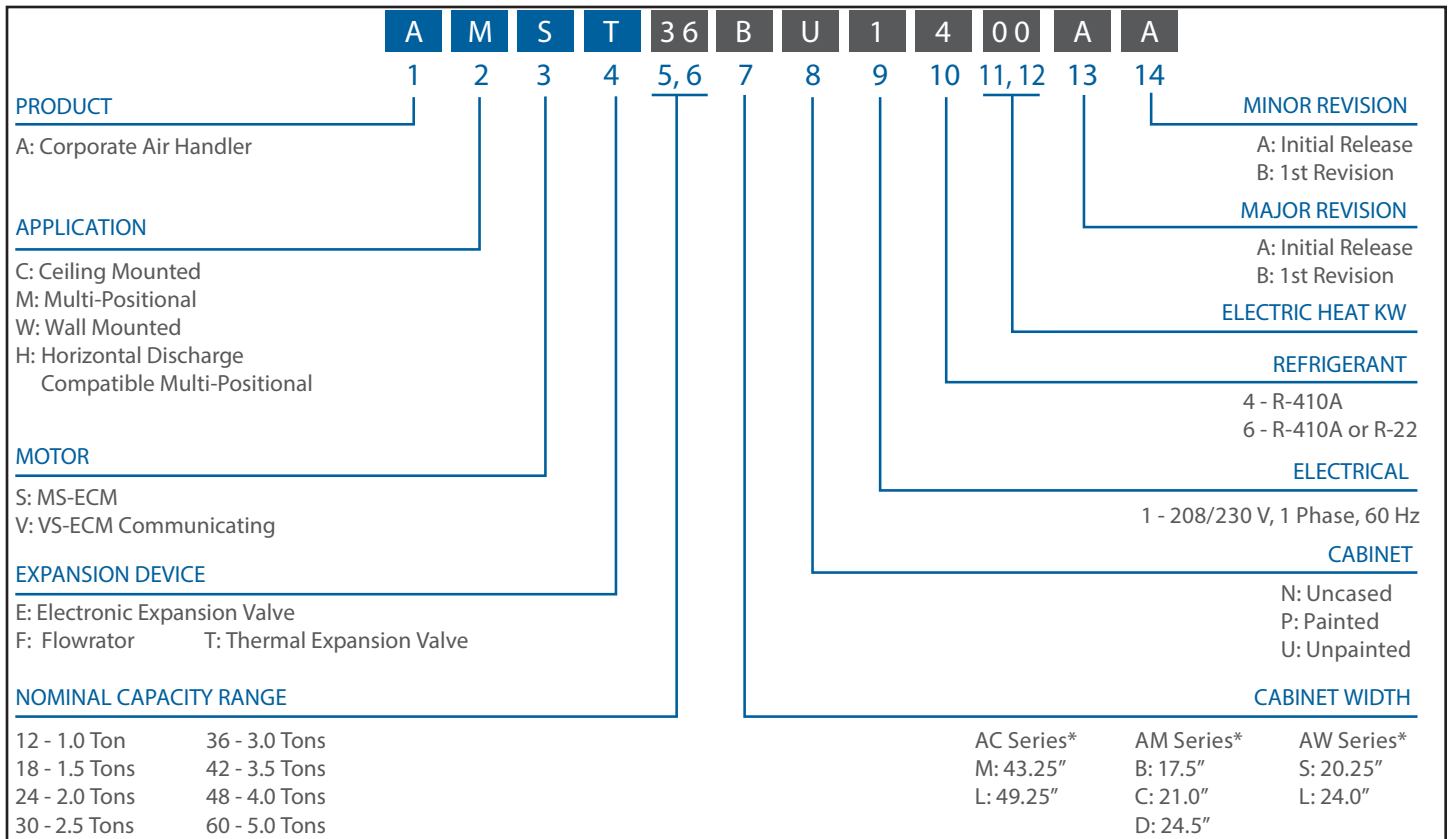

PRODUCT IDENTIFICATION

G S X 11 090 1 AA

1 2 3 4,5 6,7,8 9 10,11

Brand

G - Goodman brand
A - Amana brand

Engineering

Major/Minor Revisions

Type

S Split System

Voltage

- 1 - 208/230V Single-Phase 60 Hz
- 2 - 220/240V Single-Phase 50 Hz
- 3 - 208/230V Three-Phase 60 Hz
- 4 - 460V Three-Phase 60 Hz
- 5 - 380/415V Three-Phase 50 Hz

Type

X: Condenser R-410A
Z: Heat Pump R-410A

SEER

- 11 - 11 SEER
- 13 - 13 SEER
- 14 - 14 SEER
- 16 - 16 SEER

Nominal Capacity

- 036 - 3 Tons
- 048 - 4 Tons
- 060 - 5 Tons
- 090 - 7-1/2 Tons
- 120 - 10 Tons

A R 090 AA

1 2 3,4,5 6,7

Brand

A Single Piece
Air Handler

Engineering

Major/Minor Revisions

Unit Application

R Multi Position
PSC Motor

Nominal Capacity

090 7-1/2 Tons
120 10 Tons

For use with GSX/GSZ11 Light Commercial models only.

PRODUCT IDENTIFICATION

GSX11 LIGHT COMMERCIAL	
GOODMAN® BRAND SPLIT X-R410A CONDENSERS 11 SEER	
Model/Rev	Description
GSX11090*AA GSX11120*AA	Introduction of Goodman Light Commercial 11 SEER, R-410A Condensers.
GSX111203AB GSX110903AB GSX111204AB GSX110904AB	208-230V and 460V 3 Phase condensing units with new ball valve/brackets, suction tube/assembly and panel w/offset.

GSZ11 LIGHT COMMERCIAL	
GOODMAN SPLIT Z-R410A HEAT PUMP 11 SEER	
Model/Rev	Description
GSZ11090*AA GSZ11120*AA	Introduction of Goodman Light Commercial 11 SEER, R-410A Heat Pumps.
GSZ110903AB GSZ111203AB GSZ110904AB GSZ111204AB	208-230V and 460V 3 Phase R410A heat pump units with new ball valve/brackets, suction tube/assembly and panel w/offset.

AR LIGHT COMMERCIAL	
A SINGLE PIECE R-MULTI-POSITION PSC MOTOR	
Model/Rev	Description
AR0904A AR1204A	Introducation of new 7.5 & 10 Ton Air Handler Models, for use with GSX11 and GSZ11 Light Commercial Models.

PRODUCT IDENTIFICATION

ASZ13	
AMANA® BRAND SPLIT Z-R410A HEAT PUMP 13 SEER	
Model/Rev	Description
ASZ130**1AA	Initial release of Amana® Brand 13 SEER Heat Pump R410A.
ASZ130**1AB	Introduces new revisions with improved circuiting for effective defrost.
ASZ130[18, 36-60]1AB ASZ130[24-30]1AC	Introduces models containing crankcase heater, CCH switch and upgraded defrost control.
ASZ130[18, 36-60]1AC ASZ130[24-30]1AD	Relocation of low pressure switch from liquid line to suction line as a compressor safeguard to prevent low pressure from entering.
ASZ130[18, 36-60]1AD ASZ130[24-30]1AE	Initial release of models using single speed PSC motors; removal of low ambient temperature switch.
ASZ130241BA	Release of 2 Ton models, converting from 3/8" to 5mm condenser coils
ASZ130181AF ASZ130[24-30]1AG	Current reversing valve change from Dunan to new SanHua reversing valve
ASZ130481AF	Current Ranco reversing valve 0151M00020 replaced by SanHua 0151R00070 reversing valve
ASZ130361AG ASZ130421AH	Change from copper wound motor to aluminum wound motor.
ASZ130481AG ASZ130601AF	Create new Motor 0131M00807 & Replace 0131M00061 with 0131M00807
ASZ130181AG ASZ130[24,30]1AH	Replaced motor 0131M000266 with 0131M00811
ASZ130421AJ	Change from copper wound compressor motor to aluminum wound compressor motor. ZP34K5EPFV130 and ZP36K5EPFV130.

PRODUCT IDENTIFICATION

ASZ14	
AMANA® BRAND SPLIT Z-R410A HEAT PUMP 14 SEER	
Model/Rev	Description
ASZ140**1AA	Initial release of Amana® Brand 14 SEER Heat Pump R410A with sound blankets and Coresense control.
ASZ140**1AB	Screw locations moved in the top panel, base pans, louvers, and control box covers.
ASZ140**1AC	Horizontal style louvers.
ASZ140[18, 42-48]1AD ASZ140[24-36, 60]1AE	New steel muffler, and suction tubes w/shock loop.
ASZ140361AF ASZ140421AD ASZ140[48-60]1AE	TXV & compensator replaced with flowrator & accumulator.
ASZ140[18, 30,36]1AF ASZ140241AG ASZ14[42, 48, 60]1AE	Sanhua (RANCO) reversing valves.
ASZ140241AF	Smaller B1227315 reversing valve.
ASZ140[18,30,36]1AG ASZ140241AH ASZC160[42,48,60]1AF	Introduction of heat pumps with accumulators, crankcase heaters, and upgraded defrost control.
ASZ140361BA	Chassis size reduction from large to medium.
ASZ140[18, 30]1AH ASZ140241AJ ASZ140[42-60]1AG	Relocation of low pressure switch from liquid line to suction line as a compressor safeguard to prevent low pressure from entering.
ASZ140[18, 30]1AJ ASZ140241AK ASZ140[42-60]1AH ASZ140361BB	2 speed PSC motors replaced with single speed PSC motors.
ASZ140181AL ASZ140241AM ASZ140301AL ASZ140361BC ASZ140381AB ASZ140[42-60]1AK	Revision made for design improvement.

*ASZ14 CONTINUED ON THE NEXT PAGE

PRODUCT IDENTIFICATION

ASZ14	
AMANA® BRAND SPLIT Z-R410A HEAT PUMP 14 SEER	
Model/Rev	Description
ASZ140381AA	35" chassis with 6-channel flowrator and ZP29K5 compressor.
ASZ140[18-30]1BA	Updated ratings and agency information.
ASZ140[18-60]1KA	Introduction of ready 15, 14 SEER heat pumps to meet the 2015 energy efficiency requirement.
ASZ140[42,49]1KB	Motor change on 3 & 3.5T 14 SEER & 2 & 2.5T 16 SEER. Increase blade gap.
ASZ140181KC	Change from copper wound motor to aluminum wound motor.
ASZ140[24,30,36,48,60]1KB ASZ140[42,49]1 KC	Refrigerant Charge Reduction
ASZ140181KD	Refrigerant Charge Reduction

ASZ16	
AMANA® BRAND SPLITS Z-R410A HEAT PUMP 16 SEER	
Model/Rev	Description
ASZ160**1AA	Initial release of Amana® Brand 16 SEER Heat Pump R410A.
ASZ160**1AB	Introduces models with screw locations moved in the top panel, base pans, louvers, and control box covers.
ASZ160**1AC	Horizontal style louvers.
ASZ160**1AD	Muffler and standardized TXV, Compensator using the ASZ18 Seer weldment.
ASZ160241AD ASZ160[36-60]AE	Adds new steel muffler, and suction tubes w/shock loop.
ASZ160[24,36]1AF ASZ160[48,60]1AF	Sanhua (RANCO) reversing valves.
ASZ160[24,36,48,60]1KA	Initial release of Amana® Brand 16 SEER Heat Pump models
ASZ160[18-48]1LA	Initial release of Amana® Brand 16 SEER Heat Pump models with 9.6+ HSPF
ASZ160601LA	Initial release of Amana® Brand 5 Ton 16 SEER, 13 eer Heat Pump models.
ASZ160[24,30]1LB	Motor change on 3 & 3.5T 14 SEER & 2 & 2.5T 16 SEER. Increase blade gap.
ASZ160181LB	16SEER 1.5T Heat Pumps, Remove Hard Start Kit
ASZ160181LC	Change from copper wound motor to aluminum wound motor.
ASZ160[36,48]1LB	Create new Motor 0131M00807 & Replace 0131M00061 with 0131M00807
ASZ160421LB	Replaced motor 0131M00018P with 0131M00813

ASZ18	
AMANA® BRAND SPLIT Z-R410A HEAT PUMP 18 SEER	
Model/Rev	Description
ASZ180**1AB	Initial release of Amana® Brand 18 SEER Heat Pump R410A.
ASZ180[36,48,60]1AC	Sanhua (RANCO) reversing valves.

PRODUCT IDENTIFICATION

ANZ13	
AMANA® BRAND SPLIT SYSTEM N-BASE Z-R410A HEAT PUMP 13 SEER	
Model/Rev	Description
ANZ130[18-60]1AA	Initial release of Amana® Brand Split System Base Heat Pump, 13 Seer R-410A units.
ANZ130[18/24/30]1AB	Reversing valve change from Dunan to new SanHua reversing valve
ANZ130481AB	Ranco 0151M00020 reversing valve changed to new SanHua 0151R00070 reversing valve
ANZ130241AC	Create new Motor & Replace 0131M00294 with 0131M00800
ANZ130601AB	Create new Motor 0131M00807 & Replace 0131M00061 with 0131M00807
ANZ130[18,30]1AC	Replaced motor 0131M000266 with 0131M00811
ANZ130[36,42,48]1AC	Replaced motor 0131M00018P with 0131M00813
ANZ130421AD ANZ130421AE	Change from copper wound compressor motor to aluminum wound compressor motor. ZP34K5EPFV130 and ZP36K5EPFV130.

ANZ14	
AMANA® BRAND SPLIT SYSTEM N-BASE Z-R410A HEAT PUMP 14 SEER	
Model/Rev	Description
ANZ140(18-60)1AA	Introduction of ready 15, 14 SEER heat pumps to meet the 2015 energy efficiency requirement.
ANZ140(24-30)1AB	Energy guide update.
ANZ140181AB	Minor revisions on OD units ZP14K6 compressors without hard start kit. 14S 1.5T HPs ONLY.
ANZ140421AB ANZ140491AB	Motor change on 3 & 3.5T 14 SEER & 2 & 2.5T 16 SEER. Increase blade gap.
ANZ140[18,30]1AC ANZ140361AB	Change from copper wound motor to aluminum wound motor.
ANZ140[42,49]1AC ANZ140[48,60]1AB	Refrigerant Charge Reduction
ANZ140[18,30]1AD ANZ140361AC	Refrigerant Charge Reduction
ANZ140241AD	Equivalent motor with Aluminum Windings replacing Copper Windings.
ANZ140[48,60]1AC	Create new Motor 0131M00807 & Replace 0131M00061 with 0131M00807

ASZH5	
7.8 HSPF2 Heat Pumps	
Model/Rev	Description
ASZH5***10 15.2 SEER2	Meets the 2023 DOE Energy Conservation Standards. High efficiency coil with 5mm diameter copper tube and enhanced aluminum fins, on 1.5 to 3.0-ton units. Replaces ASZ16 single stage heat pumps.

PRODUCT IDENTIFICATION

DSZ16 DELUXE SPLIT Z-R410A HEAT PUMP 16 SEER	
Model/Rev	Description
DSZ160**1AA	Initial release of Deluxe Goodman 2-stage 16 SEER heat pumps with R-410A.
DSZ160241AC DSZ16036, 48, 60]1AB	Sanhua (RANCO) reversing valves.

DSZ18 DELUXE SPLIT Z-R410A HEAT PUMP 18 SEER	
Model/Rev	Description
DSZ180**1AA	Initial release of Deluxe Goodman 2-stage 18 SEER heat pumps with R-410A.
DSZ180[36, 48, 60]1AB	Sanhua (RANCO) reversing valves.

PRODUCT IDENTIFICATION

VSZ13	
VALUE SPLIT Z-R410A HEAT PUMP 13 SEER	
Model/Rev	Description
VSZ13**1AA	Initial release of Value Line 13 SEER heat pumps with R-410A.
VSZ130[24 & 30]1AB	Improved circuiting for effective defrost.
VSZ130[24 & 36]1BA	Initial release of models with 5mm Smart Coil™.
VSZ130[18, 42, 48]1AB VSZ130241BB VSZ130301AC	Models containing crankcase heater, CCH switch and upgraded defrost control.
VSZ130[24 & 36]1BC VSZ130301AE VSZ130[18, 42 & 48]1AD	Release of single phase models with new 6 pole motor.
VSZ130[18, 42-60]1AC VSZ130301AD	Relocation of low pressure switch from liquid line to suction line as a compressor safeguard to prevent low pressure from entering.
VSZ130241CA	Release of 2 Ton models with a compressor change from ZP21K5EPFV130 to ZP20K5EPFV130.
VSZ130181AE VSZ130421AF	Changed from four-piece louver assembly to a two piece louver assembly. Added a corner post on 26" and 29" chassis.
VSZ130361BD VSZ130301AF VSZ130481AE	Single phase models with new 6 pole motor. Changed from four-piece louver assembly to a two piece louver assembly. Added a corner post on 26" and 29" chassis.
VSZ130421AF	Compressor change from ZP36K5EPFV130 to ZP34K5EPFV130.
VSZ130241CB	2 Ton models changing from the current four piece louver assembly, to a two piece louver plus a corner post on Goodman and value series 26" and 29" chassis.
VSZ130181AF VSZ130241BD VSZ130301AG	Reversing valve change from Dunan to new SanHua.
VSZ130481AF	Ranco 0151M00020 reversing valve replaced by SanHua 0151R00070 reversing valve
VSZ130241BE	Create new Motor & Replace 0131M00294 with 0131M00800
VSZ130601AD	Create new Motor 0131M00807 & Replace 0131M00061 with 0131M00807

PRODUCT IDENTIFICATION

VSZ14	
VALUE SPLIT Z-R410A HEAT PUMP 14 SEER	
Model/Rev	Description
VSZ14[018-060]1AA	Introduction of ready 15, 14 SEER heat pumps to meet the 2015 efficiency requirement.
VSZ140(18-30)1AB	Energy guide update. PCBDM160 with new software.
VSZ140421AB VSZ140491AB	Motor change on 3 & 3.5T 14 SEER & 2 & 2.5T 16 SEER. Increase blade gap.
VSZ140[18,30]1AC VSZ140[36,48,60]1AB	Refrigerant charge reduction.
VSZ140[18, 30]1AD VSZ140361AC	Change from copper wound motor to aluminum wound motor.
VSZ140[24, 42, 49]1AC	Refrigerant Charge Reduction
VSZ140241AD	Equivalent motor with Aluminum Windings replacing Copper Windings.
VSZ140[48,60]1AC	Create new Motor 0131M00807 & Replace 0131M00061 with 0131M00807
VSZ140[18,24,30]1AF VSZ140[36,42,48,49,60]1AE	GMC product for outdoor splits is changing the paint color to match the new paint for GMC indoor furnaces being released.
VSZ140181BA	Convert VSZ 14 SEER 1.5 Ton HP from Copeland to Rechi Compressor

PRODUCT IDENTIFICATION

GSZ13	
GOODMAN SPLIT Z-R410A HEAT PUMP 13 SEER	
Model/Rev	Description
GSZ13**1AA	Initial release with Regal Beloit motor.
GSZ13**1AB GSZ13**3AA GSZ13**4AA	Initial release with Broad Ocean motor.
GSZ130[24 & 30]1AC	Release of minor revision with improved circuiting for effective defrost.
GSZ130[24 & 36]1BA	Initial release of models with 5mm Smart Coil™.
GSZ130241CA	Release of 2 Ton models with a compressor change from ZP21K5EPFV130 to ZP20K5EPFV130.
GSZ130241CB	2 Ton models changing from the current four piece louver assembly, to a two piece louver plus a corner post on Goodman and value series 26" and 29" chassis.
GSZ130[18, 42-60]1AC GSZ130301AD GSZ130361BB	Release of models containing crankcase heater, CCH switch and upgraded defrost control.
GSZ130[18,42,48,60]1AD GSZ130301AE GSZ130[36,48,60]{3,4}AB GSZ130[48,60]{3,4}AB	Relocation of low pressure switch from liquid line to suction line as a compressor safeguard to prevent low pressure from entering.
GSZ130[18,42,48]1AF GSZ130301AG GSZ130[36,48]3AD GSZ130484AC	Changing from the current four piece louver assembly, to a two piece louver plus a corner post on Goodman and value series 26" and 29" chassis.
GSZ130361BC GSZ130[42,48]1AE	Release of models with new 6 pole motor/fan combination.
GSZ130361BD	Models with new 6 pole motor/fan combination. Changing from the current four piece louver assembly, to a two piece louver plus a corner post on Goodman and value series 26" and 29" chassis.
GSZ130421AF	Release of two piece louver plus corner post on 26" and 29" chassis with compressor changing from ZP36K5EPFV130 to ZP34K5EPFV130.
GSZ130[36, 48]3AC	Release of 3 phase models with new 6 pole motor.
GSZ14**1AA	Initial release of 14 SEER models.
GSZ130481AG GSZ130483AE GSZ130484AD	Replaced Ranco reversing valve 0151M00020 with SanHua 0151R00070 reversing valve .

PRODUCT IDENTIFICATION

GSZ13	
GOODMAN SPLIT Z-R410A HEAT PUMP 13 SEER	
Model/Rev	Description
GSZ130[19,31]1AD GSZ130241BE GSZ130251AC	Create new Motor & Replace 0131M00294 with 0131M00800
GSZ130601AE	Create new Motor 0131M00807 & Replace 0131M00061 with 0131M00807
GSZ130181AH GSZ130301AJ	Replaced motor 0131M000266 with 0131M00811
GSZ130361BF GSZ130371AD GSZ130421AJ GSZ130481AH	Replaced motor 0131M00018P with 0131M00813
GSZ130421AK GSZ130421AL	Change from copper wound compressor motor to aluminum wound compressor motor. ZP34K5EPFV130 and ZP36K5EPFV130.

GSZ14	
GOODMAN SPLIT Z-R410A HEAT PUMP 14 SEER	
Model/Rev	Description
GSZ140(18-60)1KA GSZ140491AA	Introduction of ready 15 14 SEER heat pumps to meet the 2015 energy efficiency requirement.
GSZ140(18-30)1KB	Energy guide update. PCBDM160 with new software.
GSZ140301KC GSZ140361KB	Migrating from copper to aluminum motors.
GSZ140[42,49]1KB	Motor change on 3 & 3.5T 14 SEER & 2 & 2.5T 16 SEER. Increase blade gap.
GSZ140181KC GSZ140361KC	Refrigerant charge reduction
GSZ140[24,30]1KD GSZ140[48,60]1KB	New model revisions, GSZ140241KD, GSZ140301KD, GSZ140481KB and GSZ140601KB will have the BOMs changed and have a lower refrigerant charge.
GSZ140[24,30]1KE GSZ140[48,60]1KC	New model revisions to deplete current overstock of Ranco reversing valves
GSZ140181KD	Change from copper wound motor to aluminum wound motor.
GSZ140[42,49]1KC	Refrigerant charge reduction
GSZ140241KF	Equivalent motor with Aluminum Windings replacing Copper Windings.
GSZ140371AB GSZ140[48,60]1KD	Create new Motor 0131M00807 & Replace 0131M00061 with 0131M00807

PRODUCT IDENTIFICATION

GSZ16 GOODMAN SPLIT Z-R410A HEAT PUMP 16 SEER	
Model/Rev	Description
GSZ160[18-48]1BA	Initial release of Goodman 16 SEER, 13 EER Heat Pumps with 9.0+ HSPF
GSZ1160601BA	Initial release of Goodman 5 Ton 16 SEER, 13 EER Heat Pumps
GSZ160241BB GSZ160301BB	Motor change on 3 & 3.5T 14 SEER & 2 & 2.5T 16 SEER. Increase blade gap.
GSZ160181BB	16 SEER 1.5T Heat Pumps, Remove Hard Start Kit
GSZ160181BC	Equivalent motor with Aluminum Windings replacing Copper Windings.
GSZ160181BD GSZ160[24,30]1BC GSZ160[36,42,48,60]1BB	Switching current Goodman 16SEER condensers and heat pumps with grille tops to louver tops to be consistent with other Goodman units having louver-style top panels.
GSZ160[36,48]1BC	Create new Motor 0131M00807 & Replace 0131M00061 with 0131M00807
GSZ160421BC	Replaced motor 0131M00018P with 0131M00813

GSZH5 7.8 HSPF2 Heat Pumps	
Model/Rev	Description
GSZH5***10 15.2 SEER2	Meets the 2023 DOE Energy Conservation Standards. High efficiency coil with 5mm diameter copper tube and enhanced aluminum fins, on 1.5 to 3.0-ton units. Replaces GSZ16 single stage heat pumps.

PRODUCT IDENTIFICATION

SSZ14	
SPECIAL HIGH FEATURE SPLIT Z-R410A HEAT PUMP 14 SEER	
Model/Rev	Description
SSZ140**1AA	Initial release of Goodman 14 SEER Heat Pump R410A.
SSZ140**1AB	Screw locations moved in the top panel, base pans, louvers, and control box covers.
SSZ140**1AC	Broad Ocean Motors.
SSZ140181AC SSZ140241AF SSZ140301AD	Discharge line mufflers added.
SSZ140361AF SSZ140[42-60]1AD	Added discharge line mufflers. Replaced TXV and compensator with flowrator and accumulator.
SSZ140241AG	Smaller B1227315 reversing valve.
SSZ140[18, 30, 42-60]AE SSZ140241AH SSZ140361AG	Sanhua (RANCO) reversing valves.
SSZ140[18, 30, 42-60]AF SSZ140241AJ SSZ140361AH	Introduction of heat pumps with accumulators, crankcase heaters, and upgraded defrost control.
SSZ140[18,30]1AH SSZ140241AL SSZ140361BB	Changed from four-piece louver assembly to a two piece louver assembly. Added a corner post on Goodman 26" and 29" chassis.
SSZ140140[18, 30]1AJ SSZ140[19, 25]1AC SSZ140[31, 37]1AC SSZ140241AM SSZ140361BCC SSZ140381AB SSZ140140381AB SSZ140[42-60]AH	Revision made for design improvement.
SSZ140[18-60]1AD	Relocation of low pressure switch from liquid line to suction line as a compressor safeguard to prevent low pressure from entering.
SSZ140361AF SSZ140[42-60]1AD	Chassis size reduction from large to medium.
SSZ140381AA	Initial release of 35" chassis with 6-channel flowrator and ZP29K5 compressor.
SSZ140[18-30]1BA	Updated ratings and agency information.
SSZ140241BB SSZ140251AE	Change from copper wound motor to aluminum wound motor.
SSZ140361BE SSZ140371AE SSZ140[42,48,60]1AK	Create new Motor 0131M00807 & Replace 0131M00061 with 0131M00807

PRODUCT IDENTIFICATION

SSZ16	
SPECIAL HIGH FEATURE SPLIT Z-R410A HEAT PUMP 16 SEER	
Model/Rev	Description
SSZ16**1AA	Initial release of Goodman 16 SEER Heat Pump R410A.
SSZ16**1AB	Screw locations moved in the top panel, base pans, louvers, and control box covers.
SSZ16**1AC	Broad Ocean Motor. Updated muffler and standardized TXV. Compensator using ASZ18 SEER weldment to the SSZ160601AC.
SSZ16[024-48]1AC SSZ160601AD	Discharge line mufflers added.
SSZ160361AF SSZ160[42-60]1AD	Added discharge line mufflers. Replaced TXV and compensator with flowrator and accumulator.
SSZ160241AF SSZ160[36, 48]1AD SSZ160601AE	Sanhua (RANCO) reversing valves.
SSZ160241AF SSZ160[36-48]1AE SSZ160601BA	Introduction of heat pumps with accumulators, crankcase heaters, and upgraded defrost control.
SSZ160241AH	Changed from four-piece louver assembly to a two piece louver assembly. Added a corner post on Goodman 26" and 29" chassis.
SSZ160601BB	Ultratech® compressor
SSZ160241AK	Change from copper wound motor to aluminum wound motor.

PRODUCT IDENTIFICATION

GSX13	
GOODMAN BRAND SPLIT X-R410A CONDENSERS 13 SEER	
Model/Rev	Description
GSX130**1AA	Initial release of Goodman 13 SEER R-410A Condensers with Regal Beloit motors
GSX13061[1/3/4]AA	Introduction of Goodman 13 SEER R-410A Condensers that supplement our current 5 ton models.
GSX130363AB GSX130484AB GSX130603AB GSX130604AB	Changed from the current four piece louver assembly, to a two piece louver plus a corner post on Goodman and value series 26" and 29" chassis.
GSX130**1AB	Broad Ocean motors.
GSX130483AB	3 Phase model with new 6 pole motor.
GSX130483AC	3 phase model changing from the current four piece louver assembly, to a two piece louver plus a corner post on Goodman and value series 26" and 29" chassis.
GSX130181EA GSX130181EB	Introduction of 1.5 ton condenser with Rechi Compressor.
GSX130**1BA GSX130**3AA GSX130**4AA	Introduction of Goodman 13 SEER R-410A Condensers using SmartCoil® coils. Units will have new louvers because units are smaller. Piston size change. Other components unchanged.
GSX130301BB	Replaced fan motor to -294 and fan blade to -18 on GSX130301BA models.
GSX130[42, 48]1BC GSX130301BC GSX130601BB	Changed from the current four piece louver assembly, to a two piece louver plus a corner post on Goodman and value series 26" and 29" chassis.
GSX130[42, 48]1BB	New 6 pole motor/fan combination.
GSX130181CA	Rotary compressor.
GSX130421CA GSX130481CA	Introduction of Goodman 3.5 and 4 ton 13 SEER condensing units with reciprocating compressor.
GSX130361CA	Replaced current compressor with compressor ZP29K5EPFV130.
GSX130[18-36]1DA	Condenser conversion to 23" chassis for the 1.5 - 3 ton models.
GSX130181ED	Changed from a 4 leg Rechi Compressor 50N382XV-ZAKM to 3 Leg Rechi Compressor 50N382XV-5AKM. Changed Suction line Assy from 0210R01608 to 0210R01406. This minor
GSX13031DB	Improved coil circuit assembly for greater capacity/efficiency and a new discharge tubing assembly.
GSX130361EA	Introduction of Goodman 3 ton conversion from 29" chassis to 26".
GSX130361EB	Changed from the current four piece louver assembly, to a two piece louver plus a corner post on Goodman and value series 26" and 29" chassis.
GSX130371AA	Improved decibel ratings for Canadian market.
GSX130181EF	Change from motor 0131M00276 to 0131M00593 on units GSX130181 & VSX130181
GSX130363AD	Change from copper wound motor to aluminum wound motor.
GSX130241EC GSX130301BF	Create new Motor & Replace 0131M00294 with 0131M00800

PRODUCT IDENTIFICATION

GSX13 GOODMAN BRAND SPLIT X-R410A CONDENSERS 13 SEER	
Model/Rev	Description
GSX130611AC	Create new Motor 0131M00807 & Replace 0131M00061 with 0131M00807
GSX130241ED GSX130[30,60]1BG GSX130361EE GSX130[42,48]1BF	Factory Refrigerant Charge Optimization
GSX130181EH	Changing Flat BOM structure to Indented BOM structure
GSX130181EG	Switching 3-legged and 4-legged compressors in 13SEER and 14SEER condensers to those with improved overload protection (OLP).
GSX130181EJ	Switching compressor from 50N382XV-5AKM to 50N382YV-5AKM
GSX130301LA	13 SEER 2_5T Condenser Rechi Conversion - Switch from Copeland compressor to Rechi compressor in 13 SEER 2.5 ton condensers (GSX, VSX, ANX)
GSX130361EF GSX130[42,48]1BG GSX130483AE GSX130601BH	Replaced motor 0131M00018P with 0131M00813
GSX130421BH GSX130421BJ	Change from copper wound motor to aluminum wound motor.
GSX130301LB	Change from copper wound motor to aluminum wound motor.
GSX130241FA	Reduce chassis size to 23" base

PRODUCT IDENTIFICATION

GSX14 GOODMAN BRAND SPLIT X-R410A CONDENSERS 14 SEER	
Model/Rev	Description
GSX14**1AA	Introduction of Goodman 14 SEER R-410A models.
GSX140[18-19]1KA GSX140[24-25]1KA GSX140[30-31]1KA GSX140[36-37]1KA GSX140[42, 48, 60]1KA	Goodman S plit X 14 Seer Condensing units. Introducing the Goodman 14 SEER standard condenser 5mm architecture with updated scroll compressors.
GSX140241KB	Replaced 1/12hp fan motor with 1/8hp fan motor.
GSX140311AA	Introduction of 12.2 EER air conditioning units.
GSX140[30-36,42]1KB	Migrating from copper to aluminum motors.
GSX140251LA	Changed compressor from K5 to K6, Changed coil slab from 25" tall to 30" tall, Changed louvers from 24" tall to 29" tall
GSX140241LB	Create minor revisions of the new Rechi 2.0T units to consume the excess inventory of 19P fan motor
GSX140191KB	Remove HS Kit from Control Panels of condenser units with updated ZP14K6E scroll compressors.
GSX140361KC GSX140371KB GSX140421KC GSX140 [43,48,60]1KB	Refrigerant charge reduction.
GSX140311KB GSX140371KC GSX140431KC	Change from copper wound motor to aluminum wound motor.
GSX140[48,60]1KC	Create new Motor 0131M00807 & Replace 0131M00061 with 0131M00807
GSX140301LA	Changing from Copeland to Rechi in 14 SEER 2.5T condenser units: Project involves moving to a larger coil, and added accessories for the Rechi application.
GSX140181LB	Switching 3-legged and 4-legged compressors in 13SEER and 14SEER condensers to those with improved overload protection (OLP).
GSX140241LD	Charge Optimization for 14 SEER 2T lineup
GSX140[36,42]1KE	Charge Optimization for 14 SEER 3T and 3.5T condenser units
GSX140181LC GSX140191KC GSX140251BB	Replaced motor 0131M000266 with 0131M00811
GSX140241LC	Replaced motor 0131M000266 with 0131M00811 Refrigerant Charge Change
GSX140[37,43]1KD	Charge optimization for Southwest 14 SEER models
GSX140301KC	Reinstatement and new minor revision
GSX140181MA	Reduce chassis size to 23" base

PRODUCT IDENTIFICATION

GSX16 GOODMAN BRAND SPLIT X-R410A CONDENSERS 15 AND 16 SEER	
Model/Rev	Description
GSX160**1FA	Initial release of the Goodman 16 SEER R410A Condensers.
GSX160611FA	New high capacity 5 ton model that will supplement the current GSX160601 models.
GSX160[18-61]1FB	Minor revision for GSX16s to include ball valves 0151R00045 and 0151R00046.
GSX160601GA	7mm coils.
GSX160(48/60/61)1FB	Ball valve change from 0151R00046 to 0151R00081
GSX160(18/24/30/36)1FC	Migrating from copper to aluminum motors.
GSX160(18/24/30/36)1FC GSX160(42/48/60/61)1FC	Ball Valve Re-work 0151R00045 & 0151R00046
GSX160311AA GSX160371AA	Initial release creates and launches 2 new SKUs in the 16 SEER single-stage AC product line.
GSX160[24, 30, 60]1FE	Refrigerant charge reduction.
GSX160[31,37]1AB	Equivalent motor with Aluminum Windings replacing Copper Windings.
GSX160[18,36,42,48,61]1FE GSX160[24,30]1FF GSX160[31,37]1AC	Switching current Goodman 16SEER condensers and heat pumps with grille tops to louver tops to be consistent with other Goodman units having louver-style top panels.
GSX160[48,61]1FF	Create new Motor 0131M00807 & Replace 0131M00061 with 0131M00807
GSX160421FG GSX160481FH	Change from copper wound compressor motor to aluminum wound compressor motor. ZP34K5EPFV130 and ZP36K5EPFV130.
GSX16S[18-48]1AA GSX16A[18-60]1AA	Releasing new top level nomenclature for the 16 SEER condenser family. The "0" that previously followed the GSX16 family name (preceding the nominal capacity digits) will now be used to designate the region the product can be sold in (A=All Regions, N=Nor
GSX16S301AB	QIP Factory Refrigerant Charge Optimization.

GSXH5 Air Conditioners	
Model/Rev	Description
GSXH5***10 15.2 SEER2	Meets the 2023 DOE Energy Conservation Standards. High efficiency coil with 5mm diameter copper tube and enhanced aluminum fins, on 1.5 to 3.0-ton units. Replaces GSX16 single stage air conditioners.

PRODUCT IDENTIFICATION

SSX14	
SPECIAL HIGH FEATURE SPLIT X-R410A CONDENSERS 14 SEER	
Model/Rev	Description
SSX140**1AA	Initial release of Goodman 14 SEER AC 410A.
SSX140**1AB	Revisions have screw locations moved in the top panel, base pans, louvers, and control box covers.
SSX14018, 241AC	Revised condenser coils by removing [1] haripin.
SSX140301AC	Model contains the Broad Ocean motor 0131M00060
SSX14036-601AC	Models contain the Broad Ocean motor 0131M00061
SSX14030,361AD	Revised condenser coils by removing [1] haripin.
SSX140421AD	Introduces SSX140421A in 29" base pan
SSX140[18-24]1BA SSX140[30-36]1BA SSX140421CA	Converts 1.5 - 3.5 ton condenser coil tubes from 3/8" tube diameter to 5mm tube diameter.
SSX140[18-36]1BC SSX140421CC	Changing from the current four piece louver assembly, to a two piece louver plus a corner post on Goodman and value series 26" and 29" chassis.
SSX140[18-36]1BD SSX140421CD SSX140481BB SSX140601AG	Revision made for design improvement.
SSX140421BA	Revision for SSZ140421B* in 29 base pan and it will the reduce the unit charge from 180 oz. to 170 oz. and replace the 1/4 hp outdoor unit motor with 1/6 hp motor.
SSX14030-421AE	Revised condenser coils by removing [1] haripin.
SSX140[18-48]1BA SSX14042-481CA	Introduction of Goodman 14 SEER R-410A Condensers with SmartCoil® Coils.
SSX140[18-36]1BB SSX140421CB SSX140601AF	Relocation of low pressure switch from liquid line to suction line as a compressor safeguard to prevent low pressure from entering.

PRODUCT IDENTIFICATION

SSX16	
SPECIAL HIGH FEATURE SPLIT X-R410A CONDENSER 16 SEER	
Model/Rev	Description
SSX160**1AA	Introduces Goodman 16 SEER AC 410A
SSX160**1AB	New revisions have screw locations moved in the top panel, base pans, louvers, and control box covers.
SSX160**1AB SSX160591AA	New revisions have screw locations moved in the top panel, base pans, louvers, and control box covers.
SSX160[24, 36, 48]1BA SSX160[30 & 42]1AA	SmartCoil® coils.
SSX160[24, 36]1BC SSX160[30, 42]1AB	Changing from the current four piece louver assembly, to a two piece louver plus a corner post on Goodman and value series 26" and 29" chassis.
SSX160601BA	ZPS49K compressor.
SSX160[24,36,60]1BB	Relocation of low pressure switch from liquid line to suction line as a compressor safeguard to prevent low pressure from entering.

DSX16	
DELUXE SPLIT X-R410A HEAT PUMP 16 SEER	
Model/Rev	Description
DSX160**1AA	Initial release of Goodman 2-stage, 16 SEER condensing units with R-410A.
DSX160[24, 36]1BA	Conversion of 2 & 3 ton models to SmartCoil® Coils.
DSX160241BC	Introduces Ultratech® 2.0 compressor changes.

DSX18	
DELUXE SPLIT X-R410A HEAT PUMP 18 SEER	
Model/Rev	Description
DSXC18**1AA	Initial release of 2-stage condensing units with R-410A communicating models.
DSXC18036AB DSXC18048AB DSXC18060AB	Updated wiring diagram with notes for communicating condensing units.
DSXC18036AC	Replaced existing compressor ZPS20K4EPFV230 to ZPS20K5EPFV130 & existing compressor ZPS30K4EPFV230 to ZPS30K5EPFV130 for communicating condensing units.
DSXC180[48-60]AC	Initial release of Ultratech 2.0 to communicating condensing units

PRODUCT IDENTIFICATION

VSX13	
VALUE SPLIT X-R410A CONDENSER 13 SEER	
Model/Rev	Description
VSX130[18-48]1AA	Introduces Value Line 13 SEER condensing units with R-410A.
VSX130611AA	Supplements the 5 ton model GSX130611 to enhance performance.
VSX130301AB	Replaced fan motor to -294 and fan blade to -18 on the VSX130301AA.
VSX130301AC VSX130[42-48]1AC	Changed from current four piece louver assembly to a two piece louver assembly plus a corner post on Goodman and value series 26" and 29" chassis.
VSX130[42-48]1AB	Replaced with 6-pole motor and Copeland compressor.
VSX130181BA	Rotary compressor.
VSX130181EA VSX130181EB	Introduction of 1.5 ton condenser with Rechi Compressor.
VSX130181ED	Changed 4-leg Rechi Compressor 50N382XV-ZAKM to 3-Leg Rechi Compressor 50N382XV-5AKM. Changed Suction line Assy from 0210R01608 to 0210R01406.
VSX130241BA	2.0 ton condensing units with aluminum coils, aluminum manifolds w/existing scroll compressor.
VSX130361BA	Replaced current compressor with compressor ZP29K5EPFV130.
VSX130361EB	Changed from current four piece louver assembly, to a two piece louver plus a corner post on Goodman and value series 26" and 29" chassis.
VSX130601BA	Condensing units with SmartCoil® coils.
VSX130601BB	Changing from the current four piece louver assembly, to a two piece louver plus a corner post on Goodman and value series 26" and 29" chassis.
VSX130421BA VSX130481BA	3.5 and 4 ton 13 SEER condensing units with reciprocating compressor.
VSX130[18-36]1DA	3.5 and 4 ton 13 SEER Condensers conversion to 23" chassis for the 1.5 - 3 ton models.
VSX130301DB	2.5 13 SEER Condensers with improved coil circuit assembly for greater capacity/efficiency and the creation of a new discharge tubing assembly.
VSX130301EA	3 Ton 13 SEER Condensers release of 3 ton models converting from 29" chassis to 26" chassis.
VSX130241EA	2.0 Ton 13 SEER Condensers with Rechi Compressor, converting 23" chassis to 26" chassis
VSX130371AA	2.5 13 SEER Condensers with improved decibel ratings for Canadian market.
VSX130241EB	Compressor wires yellow, red and black changing from 40" to 45".
VSX130181EF	Change from motor 0131M00276 to 0131M00593 on units GSX130181 & VSX130181
VSX130241ED VSX130301AF	Create new Motor & Replace 0131M00294 with 0131M00800

PRODUCT IDENTIFICATION

VSX13 VALUE SPLIT X-R410A CONDENSER 13 SEER	
Model/Rev	Description
VSX130611AC	Create new Motor 0131M00807 & Replace 0131M00061 with 0131M00807
VSX13[241,361]EE VSX130301AG VSX130[421,481]AF VSX130601BE	Factory Refrigerant Charge Optimization
VSX130181EH	Changing Flat BOM structure to Indented BOM structure
VSX130181EG	Switching 3-legged and 4-legged compressors in 13SEER and 14SEER condensers to those with improved overload protection (OLP).
VSX130181EJ	Switching compressor from 50N382XV-5AKM to 50N382YV-5AKM
VSX130301LA	13 SEER 2_5T Condenser Rechi Conversion - Switch from Copeland compressor to Rechi compressor in 13 SEER 2.5 ton condensers (GSX, VSX, ANX)
VSX130361EF VSX130[42,48]1AG VSX130601BF	Replaced motor 0131M00018P with 0131M00813
VSX130181EL VSX130241EG VSX130301LB VSX130361EH VSX130421AM VSX130421AL VSX130481AJ VSX130601BH VSX130611AE	GMC product for outdoor splits is changing the paint color to match the new paint for GMC indoor furnaces being released.
VSX130421AJ VSX130421AK	Change from copper wound motor to aluminum wound motor.
VSX130301LC	Change from copper wound motor to aluminum wound motor.
VSX130241FA	Reduce chassis size to 23" base

PRODUCT IDENTIFICATION

VSX14 VALUE SPLIT X-R410A CONDENSER 13 SEER	
Model/Rev	Description
VSX140[18-19]1AA VSX140[24-25]1AA VSX140[30-31]1AA VSX140[36-37]1AA VSX140[42, 48, 60]1AA	Introducing the 14 SEER standard condenser 5mm architecture with updated scroll compressors.
VSX140241AB	Replaced 1/12hp fan motor with 1/8hp fan motor.
VSX140251BA	Changed compressor from K5 to K6, Changed coil slab from 25" tall to 30" tall, Changed louvers from 24" tall to 29" tall
VSX140241BB	Create minor revisions of the new Rechi 2.0T units to consume the excess inventory of 19P fan motor
VSX140191KB	Remove HS Kit from Control Panels of condenser units with updated ZP14K6E scroll compressors.
VSX140[30,31]1AB VSX140[36-43]1AC	Change from copper wound motor to aluminum wound motor.
VSX140301BA	Copeland to Rechi 2.5 T update suct tube, fix liq line assy, fix wiring diagram, change charge qty.
VSX140[48,60]1AC	Create new Motor 0131M00807 & Replace 0131M00061 with 0131M00807
VSX140181BB	Switching 3-legged and 4-legged compressors in 13SEER and 14SEER condensers to those with improved overload protection (OLP).
VSX140241BD	Charge Optimization for 14 SEER 2T lineup
VSX140[36,42]1AE	Charge Optimization for 14 SEER 3T and 3.5T condenser units
VSX140181BC VSX140191AC VSX140251BB	Replaced motor 0131M000266 with 0131M00811
VSX140241BC	Replaced motor 0131M000266 with 0131M00811 Refrigerant Charge Change
VSX140[37,43]1AD	Charge optimization for Southwest 14 SEER models
VSX140[18,24]1BF VSX140[18,25]1BE VSX140[19,36,42]1AF VSX140[19,37,43,48,60]1AE VSX140241BG VSX140251BD VSX140301BC VSX140311AD	GMC product for outdoor splits is changing the paint color to match the new paint for GMC indoor furnaces being released.
VSX140181CA	Reduce chassis size to 23" base

PRODUCT IDENTIFICATION

ANX13	
AMANA® BRAND SPLIT SYSTEM N-BASE X-R410A CONDENSERS 13 SEER	
Model/Rev	Description
ANX130[18-24]1AA	Launch of the Tier 1.5T & 2.0T models. Launched with 26" chasis to accommodate horizontal style louvers.
ANX130[30-61]1AA	Initial release.
ANX130241BA	Convert ANX13/14 1.5 and 2 ton models to Rechi compressors.
ANX130[30-60]1AD	Refrigerant Charge Reduction
ANX130241BB ANX130301AE	Create new Motor & Replace 0131M00294 with 0131M00800
ANX130611AD	Create new Motor 0131M00807 & Replace 0131M00061 with 0131M00807
ANX130241BC ANX130301AF ANX130[36,42,48,60]1AE	Factory Refrigerant Charge Optimization
ANX130181BA	New major revision of ANX130181 as a result of change to Rechi compressor. Rechi compressor and associated parts (grommets, bolts, wires, associated tubing, etc.) will replace the current compressor and associated parts.
ANX130301BA	13 SEER 2_5T Condenser Rechi Conversion - Switch from Copeland compressor to Rechi compressor in 13 SEER 2.5 ton condensers (GSX, VSX, ANX)
ANX130181AC ANX130181BB	Replaced motor 0131M000266 with 0131M00811
ANX130181BC ANX130181BD	Replaced 50N382XV-ZAKM Rechi compressor with rechi 50N382YV-ZAKM compressor in all models.
ANX130[36,42,48,60]1AF	Replaced motor 0131M00018P with 0131M00813
ANX130421AG ANX130421AH	Change from copper wound motor to aluminum wound motor.
ANX130301BB	Change from copper wound motor to aluminum wound motor.

PRODUCT IDENTIFICATION

ANX14	
AMANA® BRAND SPLIT SYSTEM N-BASE X-R410A CONDENSERS 14 SEER	
Model/Rev	Description
ANX140[18-60]1AA	Introducing the Amana® Brand 14 SEER standard condenser 5mm architecture with updated scroll compressors.
ANX140241AB	Replaces 1/12hp fan motor with 1/8hp fan motor.
ANX140431AA	Introduction of ready 15, 12.2 EER air conditioning units.
ANX140251BA	Changed compressor from K5 to K6, Changed coil slab from 25" tall to 30" tall, Changed louvers from 24" tall to 29" tall
ANX140191AB	Remove HS Kit from Control Panels of condenser units with updated ZP14K6E scroll compressors.
ANX140181BA ANX140241BA	Convert ANX13/14 1.5 and 2 ton models to Rechi compressors.
ANX140[30-37]1AB ANX140[42,43]1AB	Change from copper wound motor to aluminum wound motor.
ANX140481AB ANX140601AB	Refrigerant Charge Reduction
ANX140[36,37]1AC ANX140[42,43]1AC	Refrigerant Charge Reduction
ANX140[48,60]1AC	Create new Motor 0131M00807 & Replace 0131M00061 with 0131M00807
ANX140301BA	Changing from Copeland to Rechi in 14 SEER 2.5T condenser units: Project involves moving to a larger coil, and added accessories for the Rechi application.
ANX140181BB	Switching 3-legged and 4-legged compressors in 13SEER and 14SEER condensers to those with improved overload protection (OLP).
ANX140241BC	Charge Optimization for 14 SEER 2T lineup
ANX140[36,42]1AD	Charge Optimization for 14 SEER 3T and 3.5T condenser units
ANX140181BC ANX140191AC ANX140251BB	Replaced motor 0131M000266 with 0131M00811
ANX140241BB	Replaced motor 0131M000266 with 0131M00811 Refrigerant Charge Change
ANX140[37,43]1AD	Charge Optimization for Southwest 3T and 3.5T lineup

PRODUCT IDENTIFICATION

ASX13	
AMANA® BRAND SPLIT X-CONDENSERS 13 SEER	
Model/Rev	Description
ASX130**1AA	Initial release new models of Amana® Brand Deluxe 13 SEER AC R410A conditioners.
ASX130611AA	Initial release of new models of Amana® Brand Deluxe 13 SEER AC R410A conditioners; replaced ASX130601* models.
ASX130611AA	Introduction of Amana® brand 13 SEER R-410A Condensers that supplement our current 5 ton models.
ASX130**1BA	Initial release of models using SmartCoil® coils. Smaller units with new louvers. Piston size changed; other components unchanged.
ASX130**1CB	Relocation of low pressure switch from liquid line to suction line. Compressor safeguard to prevent low pressure from entering.
ASX130181DA	Initial release of models with new 266 fan motor; Low pressure switch removed.
ASX130181DB ASX130[24-48]1CD ASX130601CC	Low pressure switch 013M00082 added; updated wiring diagram.
ASX130[24-48]1CC ASX130601CB	Initial release of models with single speed PSC motors; Does not contain a low pressure switch, low ambient temperature switch and relay.
ASX130361DA	Release of 3 ton models with a 26" chassis.
ASX130361DE	Refrigerant Charge Reduction
ASX130[42,48]1CF ASX130601CE ASX130611AC	Create new Motor 0131M00807 & Replace 0131M00061 with 0131M00807
ASX130[24,30,60]1CF ASX130361DF ASX130[42,48]1CG	Factory Refrigerant Charge Optimization
ASX130181DD ASX130[24,30]1CG	Replaced motor 0131M000266 with 0131M00811
ASX130361DG	Replaced motor 0131M00018P with 0131M00813
ASX130421CH	Change from copper wound compressor motor to aluminum wound compressor motor. ZP34K5EPFV130 and ZP36K5EPFV130.

PRODUCT IDENTIFICATION

ASX14 AMANA® BRAND SPLIT X-CONDENSERS 14 SEER	
Model/Rev	Description
ASX140**1AA	Initial release of models of Amana® Brand Deluxe 14 SEER AC R410A conditioners.
ASX140**1AB	Screw locations moved in the top panel, base pans, louvers, and control box covers.
ASX140**1AC	Horizontal style louvers.
ASX14018-361AD	Revised condenser coils by removing (1) hairpin. R410A quantity reduced by 6 ounces.
ASX140421AD	Initial release of model ASX140421A in 29" base pan
ASX140421BA	29" platform. Unit charge reduced from 180 oz. to 170 oz. 1/4 hp outdoor unit motor replaced with 1/6 hp motor.
ASX14018-361BA ASX140[42-48]1CA	1.5 - 3.5 ton condenser coil tubes converted from 3/8" tube diameter to 5mm tube diameter.
ASX140[18-30]1BA ASX140[42-48]1CA	Initial release of models using SmartCoil® coils.
ASX140[18-36]1CB ASX140421DB ASX140601BB	Low pressure switch relocated from liquid line to suction line as a compressor safeguard to prevent low pressure from entering.
ASX140[24-36]1CC ASX140421DC ASX140481CB ASX140601BC	Initial release of models with single speed PSC motors; Does not contain a low pressure switch, low ambient temperature switch and relay.
ASX140181DB ASX140[24-36]1CD ASX140421DD ASX140481CC ASX140601BD	Low pressure switch added.
ASX140181DD ASX140[24-48]1CE ASX140421DE ASX140601BE	Design improvement.
ASX140181DA	Initial release of models with new 266 fan motor; Low pressure switch removed.
ASX140[18-19, 24-25]1KA ASX140[30-31, 36-37]1KA ASX140[42, 48, 60]1KA	Initial release of 5mm architecture with updated scroll compressors.
ASX140241KB	1/8 hp fan motor replaced 1/12 hp fan motor.
ASX140241LA ASX140251LA	Changed compressor from K5 to K6, Changed coil slab from 25" tall to 30" tall, Changed louvers from 24" tall to 29" tall

*ASX14 Continued on the next page

PRODUCT IDENTIFICATION

ASX14	
AMANA® BRAND SPLIT X-CONDENSERS 14 SEER	
Model/Rev	Description
ASX140191KB	Remove HS Kit from Control Panels of condenser units with updated ZP14K6E scroll compressors.
ASX140241LA	Change compressor from K6 to K5 on ASX140241 and DX14SA0241
ASX 140[30,43]1KB	Change from copper wound motor to aluminum wound motor.
ASX 140[48,60]1KB	Refrigerant Charge Reduction
ASX 140[36,37,42,43]1KC ASX160[24,30]1FC	Refrigerant Charge Reduction
ASX140[48,60]1KC	Create new Motor 0131M00807 & Replace 0131M00061 with 0131M00807
ASX140[36,42]1KD	Charge Optimization for 14 SEER 3T and 3.5T condenser units
ASX140181KB ASX140191KC ASX140[24,25]1LB	Replaced motor 0131M000266 with 0131M00811
ASX140[37,43]1KD	Charge Optimization for Southwest 3T and 3.5T lineup

PRODUCT IDENTIFICATION

ASX16 AMANA® BRAND SPLIT X-CONDENSERS 16 SEER	
Model/Rev	Description
ASX160**1AB	Screw locations moved in the top panel, base pans, louvers, and control box covers.
ASX160**1AC	Horizontal style louvers.
ASX160**1FA	Single speed outdoor fan.
ASX160611FA	High capacity 5 ton models that supplement the current ASX160601 models.
ASX160611GA	7mm coils.
ASX160[24-60]1BA	Wiring diagram updated with notes.
ASX160[24/36]1CA	Initial release of Conversion of 2 & 3 ton models to SmartCoil® coils.
ASX160(48/60/61)1FB	Ball valve change from 0151R00046 to 0151R00081
ASX160311AA ASX160371AA	Initial release creates and launches 2 new SKUs in the 16 SEER single-stage AC product line.
ASX160[18-42]1FB	Change from copper wound motor to aluminum wound motor.
ASX160601FC	Refrigerant charge reduction
ASX160[31,37]1AB	Equivalent motor with Aluminum Windings replacing Copper Windings.
ASX160[48,61]1FC	Create new Motor 0131M00807 & Replace 0131M00061 with 0131M00807
ASX160421FC ASX160481FD	Change from copper wound compressor motor to aluminum wound compressor motor. ZP34K5EPFV130 and ZP36K5EPFV130.

ASX18 AMANA® BRAND SPLIT X-CONDENSERS 18 SEER	
Model/Rev	Description
ASX180**1AB	Initial release new models of Amana® Brand Deluxe 18 SEER AC R410A conditioners.

ASXH5 Air Conditioners	
Model/Rev	Description
ASXH5***10 15.2 SEER2	Meets the 2023 DOE Energy Conservation Standards. High efficiency coil with 5mm diameter copper tube and enhanced aluminum fins, on 1.5 to 3.0-ton units. Replaces ASX16 single stage air conditioners.

PRODUCT IDENTIFICATION

ACNF	
A-SINGLE PIECE AIR HANDLER CEILING MOUNT N-UNCASED FLOWATER	
Model/Rev	Description
ACNF****1AA	Release of all models of 13 SEER Dayton uncased air handlers.
ACNF****16AA	Release of all models of 13 SEER Dayton uncased air handlers suitable for use with R-22 & R-410A.
ACNF****1AB	Drain pan material change.
ACNF****1BA	Current wavy fin design with replaced new louvered fin design
ACNF****16DA	Converted copper coils, manifolds, hairpins, flowrators, 90° flowrator stub to aluminum. Conversion of copper 3/8" return bends to aluminum 5/16" return bends.
ACNF180[51-81]6DB ACNF240[51-81]6DB ACNF241016DB ACNF300[51-81]6DB ACNF301016DB	UL1995 heater change.
ACNF250[01/05/06/08/]16AA ACNF251016AA ACNF310[01/05/06/08/10]16AA	Change in the air handler design. The motor changed from an existing PSC to a constant torque motor.
ACNF180016DC ACNF18[0516,0616,0816]DD ACNF240016DC ACNF24[0516,0616,0816,1016]DD ACNF25[0016,0516,0616,0816,1016]AB ACNF300016DC ACNF30[0516,0616,0816,1016]DD ACNF31[0016,0516,0616,0816,1016]AB	Creation of new ACNF Minor Rev models to produce coils with non acid etched fins.

ADPF	
A-SINGLE PIECE DOWNFLOW AIR HANDLER PSC MOTOR PAINTED FLOWATER	
Model/Rev	Description
ADPF****16AA	Introduction of new 13 SEER Air Handler Models suitable for use with R-22 and R-410A.
ADPF364216AB	Replacement of the current spot welded blower housing with the same cinched or crimped design used on the 80% furnace line.
ADPF486016AB	Replacement of the current spot welded blower housing with the same cinched or crimped design used on the 80% furnace line.
ADPF304216AC	Replacement of the current spot welded blower housing with the same cinched or crimped design used on the 80% furnace line.
ADPF****1BA	Replacement of all ARPFcoils using wavy fin with louver enhanced fin.
ADPF182416CA ADPF486016CA	Replacement of existing air handler copper coils and other associated parts with aluminum components.

PRODUCT IDENTIFICATION

AEPF	
A-SINGLE PIECE E-MULTI-POSITION VARIABLE SPEED PAINTED FLOWATER	
Model/Rev	Description
AEPF****16AA	Introduction of new 13 SEER Air Handler Models suitable for use with R-22 and R-410A.
AEPF****16BA	Introduction of new models adding lower kW hit kits on the S&R plate.
AEPF****16BB	Replacement of the current spot welded blower housing with the same cinched or crimped design used on the 80% furnace line.
AEPF****16CA	Replacement of all ARPFcoils using way fin with louver enhanced fin.
AEPF313716AA	Introduction of 3-Ton Air Handler units with 3-row coil.

ARPF	
A-SINGLE PIECE AIR HANDLER R-MULTI-POSITION PSC MOTOR PAINTED FLOWRATER	
Model/Rev	Description
ARPF364216AB ARPF486016AB	Replacement of the current spot welded blower housing with the same cinched or crimped design used on the 80% furnace line.
ARPF****16BA	Way fin replaced with louver enhanced fin.
ARPF****16CA	Replaced air handler copper coils and other associated parts with aluminum components.

PRODUCT IDENTIFICATION

ARUF	
A-SINGLE PIECE AIR HANDLER R-MULTI-POSITION PSC MOTOR UNPAINTED FLOWRATOR	
Model/Rev	Description
ARUF172916AA A24-00-2RCA	Introduction of new Air Handler Models with all aluminum evaporator coils. Conversion includes coils, manifold, hairpin, flowrators, 3/8" return bend to 5/16" aluminum return bends.
ARUF****16AA	Introduction of new 13 SEER Air Handler Models suitable for use with R-22 and R-410A
ARUF364216AB ARUF486016AB ARUF364216AC	Replaced current spot welded blower housing with cinched/crimped design used on the 80% furnace line.
ARUF****16BA	Replaced wavy fin with louver enhanced fin.
ARUF****16CA	Replaced existing air handler copper coils and other associated parts with aluminum components.
ARUF***14AA ARUF***14AA ARUF***14AB	Initial release of the redesigned air handlers manufactured at the Houston furnace facility.
ARUF18B14AB ARUF24B14BA ARUF36C14BA ARUF42C14AB	R-410A only. 2 & 3 ton coil replacement. 2 ton replaced w/3 row/16" tall; 3 ton replaced with 18" tall coil. 3.5 ton model blower motor changes from 10X8 to 10X10.
ARUF24B14BB	Changed 16 Tall, 3 Row, 6 Cir Coil Assembly to 14 Tall, 3 Row, 6 Cir Coil Assembly.
ARUF24B14CA	Initial release of model to meet AHRI requirements
ARUF30C14BA	ARUF30B, 17.5 inch wide models converted to an ARUF30C, 21 inch wide model.
ARUF36C14BB ARUF42C14AC	The aluminum models changes the RBs, COs, and coil slabs to 9mm braze joints.
ARUF36C14BC ARUF30B14AC ARUF30C14BB ARUF42C14AD ARUF[48-60]D14AC	Serial plate changes
ARUF[37,43,49]C14AA	Release ARUF series airhandlers for 7mm 14SEER HP's to meet 2015 DOE energy efficiency level
ARUF[37,43,49]D14AA	Initial Release. D53 Cabinet fir 7mm 14 SEER Heat Pumps.
ARUF[47,61]D14AA	Ready 2015 - Release ARUF series airhandlers for 7mm 14SEER HP's to meet 2015 DOE energy efficiency level
ARUF[37,43,49]C14AB ARUF[37,43,47,49,61]D14AB	Revisions because of New Heater kits released
ARUF[25,29,31,]B14AB ARUF[37,43,49]C14AC ARUF[37,43,47,49,61]D14AC	Air handler revisions due to using an upgraded (thicker with higher R value) Quietflex wrapper insulation.

PRODUCT IDENTIFICATION

ARPT - R410A ONLY	
A-SINGLE PIECE AIR HANDLER R-MULTI-POSITION PSC MOTOR PAINTED FLOWRATER TXV	
Model/Rev	Description
ARPT***14AA	Initial release of the new air handlers.
ARPT***14AB	Initial release of the air handlers manufactured at the Houston furnace facility.
ARPT[18-36]B14AC ARPT[36-60]D14AC	Serial plate changes.

ASPF	
A-SINGLE PIECE AIR HANDLER S-MULTI-POSITION EEM MOTOR PAINTED FLOWRATOR	
Model/Rev	Description
ASPF****16AA	Introduction of new ASPF Air Handlers.
ASPF****16BA	Initial release of modified ASPF control scheme, to ensure blower operation during and after call for heat on units with heat kits and replacing wavy fin with louver enhanced fin on coil.
ASPF****16CA	Replaced existing air handler copper coils and other associate departs with aluminum components.
ASPF****16DA	Initial release of models with Emerson SelecTech motor. Replaced Regal-Beloit X-13 motor.
ASPF****16EA	Replaced of existing air handler copper coils and other associated parts with aluminum components and replaced Regal-Beloit X-13 motor with Emerson SelecTech motor.

ASUF	
A-SINGLE PIECE AIR HANDLER S-ENERGY EFFICIENT MOTOR UNPAINTED FLOWRATOR	
Model/Rev	Description
ASUF29B14AA ASUF39C14AA	Initial release of models in the mid-range efficiency air handler. Incorporates smart frame chassis with EEM (X-13) style motors and piston type flowrators.
ASUF49C14AA ASUF59D14AA	Initial release of mid-range efficiency air handler with X-13 motor & fixed orifice flowrator.
ASUF49C14AB ASUF59D14AB	9 mm return bend coil.
ASUF59D14ACF	our row, piston, 9 mm return bend coil.
ASUF59D14ADN	idec Pre-programmed Motor. Nidec motor can be programmed by the supplier.
ASUF29B14AB ASUF39C14AB ASUF49C14AC	Programmed Broad Ocean Motor. The supplier can program the motor.
ASUF29B14AC ASUF39C14AC ASUF49C14AD	Changed from X13 Motor IP to IGBT (Broad Ocean).

PRODUCT IDENTIFICATION

ASPT	
A-SINGLE PIECE AIR HANDLER S-MULTI-POSITION EEM MOTOR PAINTED TXV	
Model/Rev	Description
ASPT[24/36/48/60]*14	Introduction of new generation ASPT air handlers.
ASPT36C 14AB ASPT[48/60]D14AB ASPT48D 14AC	9mm return bend coil changes to new generation of ASPT air handlers.
ASPT24B 14AC ASPT30C 14AB ASPT36C 14AC	Programmed Broad Ocean Motor. The supplier can program the motor instead of furnace plant, thus eliminating any programming installing issues. The programmed label will provide by supplier.
ASPT[24, 36]B14AD ASPT30C14AC ASPT[42, 48] C14AB	X13 Motor IP changed to IGBT (Broad Ocean).
ASPT[42-48]C14AA	Initial release of models with 2+2 coil slab assy. These models are required to meet higher tonnage rating in Cabinet.
ASPT42D 14AB ASPT48D 14AD ASPT60D 14AC	Nidec Pre-programmed Motor. Nidec motor can be programmed by the supplier instead of programming at the furnace plant, thus eliminating any programming installing issues.
ASPT[25,29,37] B14AA ASPT[37,47, 59] C14AA ASPT[47, 49, 61] D14AA	Initial release of models with a 2 slab, low airflow resistant coil with a fixed speed ECM 53" cabinet size. ASPT42C and aspt48C 2+2 models discontinued.
ASPT33C14AA ASPT39C14AA ASPT49C14AA	Upgrade the current ASPT C-49 cabinets to include 1. quality improvements captured in Ready15 design. 2.include redesigned drain pan, Morrison blower housing and Emerson NXT Booster Charge AdjustableTXV.
ASPT35B14AA	Introducing 2.5 and 3 Ton Air Handler product lines.
ASPT[33,37,39,47,49,59]C14AB ASPT[47,49,61]D14AB	Revisions because of New Heater kits released
ASPT[25,29,37,]B14AB ASPT[33,37,39,47,49,59]C14AC ASPT[47,49,61]D14AC	Air handler revisions due to using an upgraded (thicker with higher R value) Quietflex wrapper insulation.
ASPT[33,39,47]BA	Revision change on ASPT33C14/39C14/47C14 air handlers to change the amps in electrical data which ends reducing the MOP size from 35 to 30 and thus increasing wire gauge size in the field for the 5kW heater kit
ASPT35B14AB	The SR plate format is changing from SR075 to SR099 and in order to track this change a minor revision is necessary.

AMST	
Model/Rev	Description
AMST**BU14	Introduction of new generation AMST air handlers.

PRODUCT IDENTIFICATION

MBR

MODULAR BLOWER AIR HANDLER R-MULTI-POSITION PSC MOTOR

Model/Rev	Description
MBR****AA-1AA	Initial release of a module blower with PSC blower motor.
MBR****AA-1AB	A quality improvement to use 0.75" Quiet Flex Insulation.
MBR****AA-1AC	Release of MBR/MBVC Models(Minor Revisions) for 11th St Plant. Dayton to Houston
MBR****AA-1AD	Add permanent sealing/condensation-control upgrades to all MB units and remove high-voltage knockouts

MBE

MODULAR BLOWER AIR HANDLER E-MULTI-POSITION VARIABLE-SPEED

Model/Rev	Description
MBE****AA-1AA	Introduction of a module blower with variable speed blower motor.
MBE****AA-1BA	Introduction of new models adding lower kW hit kits on the S&R plate.

PRODUCT IDENTIFICATION

AWUF	
A SINGLE PIECE AIR HANDLER WALL MOUNT PSC MOTOR UNPAINTED FLOWRATOR	
Model/Rev	Description
AWUF****1AA	Initial release of 13 SEER Dayton wall mount air handlers.
AWUF****16AA	Initial release 13 SEER Dayton wall mount air handlers suitable for use with R-22 and R-410A refrigerant.
AWUF3005-101AA	Introduces 13 SEER Dayton wall mount air handlers using a Burr Oak Louvered Fin coil.
AWUF****1BA	Replaced wave fin design with new louvered fin design.
AWUF370**16AA	Initial release of AWUF37 Air Handlers for use with R-22 and R410A.
AWUF****16BA	Replaced wave fin design with new louvered fin design. Replaced copper tube hairpins with aluminum hairpins.
AWUF180316BA AWUF240316BA AWUF300316BA	Initial release of AWUF 3KW Heater air handlers.
AWUF310[5/8]16AA AWUF321016AA	Initial release of higher 14 SEER AWUF series air-handlers
AWUF300[3-10]16BB AWUF360[5-10]16BB	18 x 20 x 1 filter replaced the 16 x 20 x 1 filter.
AWUF18F[3-8]16AA AWUF24F[1/8]16AA AWUF30F*16AA AWUF31F[5/8]16AA AWUF32F116AA AWUF36F*16AA AWUF37F[1/5/8]16AA	Initial release of R-401A air handlers with factory-installed float switch and a drain pan water sensor switch.
AWUF180[3-8]16BB AWUF240[3-10]16BB AWUF300[5-10]16BC AWUF310[5-10]16AB AWUF360[5-10]16BC AWUF370[5-10]6BB	UL1995 heater change to remove sequencer and replace a contactor.
AWUF190*16AA AWUF250*16AA AWUF251*16AA	Matchup to meet the new 14 SEER min efficiency levels. Uses a 4 row coil and an EEM Motor (X13 style) to achieve higher efficiency. Initial release.

*AWUF Continued on the next page

PRODUCT IDENTIFICATION

AWUF	
A SINGLE PIECE AIR HANDLER WALL MOUNT PSC MOTOR UNPAINTED FLOWRATOR	
Model/Rev	Description
AWUF180[316,516,816]BC AWUF190[316,516,816]AB AWUF240[316,516,816]BC AWUF241016BC AWUF250[316,516,816]AB AWUF251016AB AWUF300[516,816]BD AWUF301016BD AWUF310[516,816]AC AWUF321016AC AWUF360[516,816]BD AWUF361016BD AWUF370[516,816]BC AWUF371016BC	Release gasket and caps to seal leak. With this modification we will be able to meet 2% at 1 inch static leak and 1.4% leak rate at 0.5 inch static. Modified all current AWUF units to pass current air leak rate.
AWUT310[516,816]AA AWUT321016AA AWUT370[516,816]AA AWUT371016AA	AWUT is a new lineup of the AWUF wall mounted Electric Heat Air Handlers with a factory installed TXV. The lineup will be matched with a 5, 8 and 10KW heater, 208V/230V and single phase.
AWUF310516AD	Design improvement - Update MOP
AWUF180[316,516,816]BD AWUF190[316,516,816]AC AWUF240[316,516,816]BD AWUF241016BC AWUF250[316,516,816]AC AWUF251016AC AWUF300[516,816]BC AWUF301016DC AWUF310516AE AWUF310816AD AWUF321016AD AWUF360[516,816]BE AWUF361016BE AWUF[516,816]BD AWUF371016BD	Redesigned the AWUF Control Box to make it larger to allow more room to access components for serviceability in the field.
AWUT24[05,08,10]14	AWUT is a new lineup of the AWUF with a 7mm coil and a factory installed TXV. The lineup will be matched with a 5, 8 and 10KW heater, 208V/230V and single phase.

AWST	
Model/Rev	Description
AWST18SU14[03,05,08]AA AWST24SU14[05,08,10]AA AWST30LU14[05,08,10]AA AWST36LU14[05,08,10]AA	AWST replaces specific current AWUT and AWUF SKUs upon launch. All AWST units will incorporate 7mm coil and a factory installed TXV. The lineup will be matched with a 5, 8 and 10KW heater, 208V/230V and single phase.

PRODUCT IDENTIFICATION

CAPF	
C-INDOOR COIL A-UPFLOW/DOWNFLOW PAINTED FLOWRATOR	
Model/Rev	Description
CAPF****6AA	Initial release of CAPF Dayton Upflow/Downflow coils.
CAPF****6BA	Burr Oak Louvered Fin released in place of the Wavy Fin.
CAPF36***CA	Redesigned for performance improvement from 2 row to 3 row.
CAPF****6DA	Replaced existing copper coils and other associated parts with aluminum components.
CAPF****6DB	Drain pan material changed.
CAPF1824A6DC CAPF1824B6DC CAPF1824C6DC CAPF3030A6DC CAPF3030B6DC CAPF3030C6DC CAPF3030D6DC CAPF3131B6DC CAPF3131C6DC CAPF3137B6AB CAPF3636A6DC CAPF3636B6DC CAPF3636C6DC CAPF3636D6DC CAPF3642C6DC CAPF3642D6DC CAPF3743C6DC CAPF3743D6DC CAPF4860C6DC CAPF4860	Redesign the wrapper for the CAPF to provide increased ease of installation.
CAPFA1818A6AA CAPFA1818B6AA	Replaced 3/8 aluminum tubing in residential splits indoor coils with more efficient 7mm aluminum tubing.
CAPFA1818A6BA CAPFA1818B6BA	Redesigned drain pan, replace two piece access panels with single piece access panel.
CAPFA1818C6AA CAPFA2418A6AA CAPFA2418B6BA CAPFA2418C6AA CAPFA2422B6AA CAPFA2422C6AA	Initial release of CAPFA Upflow/Downflow 7mm AL Coils.
CAPFA3022B6AA CAPFA3022C6AA CAPFA3022D6AA CAPFA3626B6AA CAPFA3626C6AA CAPFA3626D6AA	Initial release of CAPFA Upflow/Downflow 7mm AL Coils.

PRODUCT IDENTIFICATION

CAPF	
C-INDOOR COIL A-UPFLOW/DOWNFLOW PAINTED FLOWRATOR	
Model/Rev	Description
CAPFA1714A6AA CAPFA1714B6AA CAPFA1818C6BA	Initial release of 7mm AL CAPFA Upflow/Downflow Coils.
CAPFA2318A6AA CAPFA2318B6AA CAPFA2318C6AA CAPFA2422A6AA CAPFA3022A6AA	Initial release of 7mm AL CAPFA Upflow/Downflow Coils.
CAPFA2922A6AA CAPFA2922B6AA CAPFA2922C6AA	Initial release of 7mm AL CAPFA Upflow/Downflow Coils.
CAPFA4226B6AA CAPFA4226C6AA CAPFA4226D6AA	Initial release of 7mm AL CAPFA Upflow/Downflow Coils.
CAPFA1714A6BA CAPFA1714B6BA CAPFA1818A6CA CAPFA1818B6CA CAPFA1818C6CA CAPFA2318A6BA CAPFA2318B6BA CAPFA2318C6BA CAPFA2418A6BA CAPFA2418B6BA CAPFA2418C6BA CAPFA2422A6BA CAPFA2422B6BA CAPFA2422C6BA CAPFA2922A6BA CAPFA2922B6BA CAPFA2922C6BA CAPFA3022A6BA CAPFA3022B6BA CAPFA3022C6BA CAPFA3022D6BA	Major revision update for A-chassis drain port relocation

PRODUCT IDENTIFICATION

CAPT	
C-INDOOR COIL A-UPFLOW/DOWNFLOW PAINTED CASED FLOWRATOR W/TXV	
Model/Rev	Description
CAPT3131B4BA CAPT3131C4BA	Initial release of coils with factory-installed, non-adjustable TXV. Single stage AHRI ratings for CAPT3131 NTC combinations.
CAPT3743C4AA CAPT3743D4AA	Initial release of single stage AHRI ratings for CAPT3743 NTC combinations.
CAPT4961C4AA CAPT4961D4AA	Initial release of single stage AHRI ratings for CAPT4961C4 NTC combinations.
CAPT3131B4AB CAPT3131C4AB CAPT3743C4AB CAPT3743D4AB CAPT4961C4AB CAPT4961D4AB	Redesign the wrapper for the CAPT to provide increased ease of installation.

CHPF	
C-INDOOR COIL HORIZONTAL A-COIL PAINTED FLOWRATOR	
Model/Rev	Description
CHPF****6AA	Initial release of 13 SEER CHPF horizontal A coil.
CHPF****6BA	Released Burr Oak Louvered Fin in place of the Way Fin. The rows changed by one, (i.e. 4 row to 3 row; 3 row to 2 row) where applicable.
CHPF1824A6CA CHPF2430B6CA CHPF3636B6CA CHPF3642C6CA CHPF3642D6CA CHPF3743C6BA CHPF3743D6BA CHPF4860D6DA	Louvered fins. Replaced copper tube hairpins with aluminum hairpins.
CHPF1824A6CB CHPF2430B6CB CHPF3636B6CB CHPF3642C6CB CHPF3642D6CB CHPF3743C6BB CHPF3743D6BB CHPF4860D6DB	Drain pan material change to a Decabromodiphenyl Ether free resin.
CHPF1824A6CC CHPF2430B6CC CHPF3636B6CC CHPF3642C6CC CHPF3642D6CC CHPF3743C6BC CHPF3743D6BC CHPF4860D6DC	Change to prepainted wrappers

PRODUCT IDENTIFICATION

CAUF/A	
C-INDOOR COIL A-UPFLOW/DOWNFLOW UNCASD FLOWRATOR	
Model/Rev	Description
CAUF****6AA	Initial release of CAUF Dayton Upflow/Downflow coils.
CAUF****6BA	Burr Oak Louvered Fin released in place of the Wavy Fin.
CAUF****6DA	Replaced existing copper coils and other associated parts with aluminum components.
CAUF****6DB	Drain pan material changed.
CAUF1824(A/B/C)6RDB CAUF3636(A/B)6RDB CAUF3636(C/D)6RDB CAUF3642(C/D)6RDB CAUF3743(C/D)6RDB CAUF4860(C/D)6RDB CAUF4961(C/D)6RDB	Manufacturing Location Change from Dayton to Houston. Designated by "R".
CAUF3137B6RAA	Manufacturing Location Change from Dayton to Houston. Designated by "R".
CAUF36***CA	Redesign from 2 row to 3 row for performance improvement.
CAUFA****6AA CAUFA****6BA	Initial release of 7mm AL CAUFA Upflow/Downflow Coils.
CAUFA****6BA CAUFA****6CA	Major revision update for A-chassis drain port relocation.

CHPTA	
Model/Rev	Description
CHPTA***6AA	Initial release of CHPTA 7mm Horizontal Coils.

PRODUCT IDENTIFICATION

CSCF	
C-INDOOR COIL S-HORIZONTAL SLAB COIL UNPAINTED FLOWRATOR	
Model/Rev	Description
CSCF****6AA	Release 13 SEER CSCF slab horizontal coil.
CSCF****6BA	Burr Oak Louvered Fin released in place of the Wavy Fin. The rows change by one, (i.e. 4 row to 3 row; 3 row to 2 row) where applicable.
CSCF1824N6BB CSCF3036N6BB CSCF3642N6CB CSCF4860N6CB	Drain pan material change.
CSCF3642N6CA CSCF4860N6CA	Release 13 SEER CSCF slab horizontal coil. Louvered fin project.
CSCF1824N6DA CSCF3036N6DA CSCF3642N6DA CSCF4860N6DA	Release 13 SEER CSCF slab horizontal coil. Converting copper coils, maifolds, haripins, flowrators to aluminum coils.

CTPF	
C-INDOOR COIL T-COATED PAINTED FLOWRATOR	
Model/Rev	Description
CTPF****6AA	Initial release of coated coils.
CTPF1824*6AB CTPF3030*6AB CTPF3131*6AB CTPF3636*6AC CTPF3642*6AB CTPF4860*6AB	Drain pan material change.

CTUF	
C-INDOOR COIL T-COATED UNPAINTED FLOWRATOR	
Model/Rev	Description
CTUF1824*6AA CTUF3030*6AA CTUF3131*6AA CTUF3636*6AA CTUF3642*6AA CTUF4860*6AA	Initial release.
CTUF1824*6AB CTUF3030*6AB CTUF3131*6AB CTUF3636*6AC CTUF3642*6AB CTUF4860*6AB	Initial release.

PRODUCT DESIGN

This section gives a basic description of cooling unit operation, its various components and their basic operation. Ensure your system is properly sized for heat gain and loss according to methods of the Air Conditioning Contractors Association (ACCA) or equivalent.

Condensing Unit

The condenser air is pulled through the condenser coil by a direct drive propeller fan. This condenser air is then discharged out of the top of the cabinet. These units are designed for free air discharge, so no additional resistance, like duct work, shall be attached.

The suction and liquid line connections on present models are of the sweat type for field piping with refrigerant type copper. Front seating valves are factory installed to accept the field run copper. The total refrigerant charge for a normal installation is factory installed in the condensing unit.

GSX, GSZ, ANX, ANZ, ASX, ASZ, SSX, SSZ, DSX, DSZ, VSX, and VSZ models are available in 1 ½ through 5 ton sizes and use R-410A refrigerant. They are designed for 208/230 volt single phase applications.

GSX/GSZ *****3 models are available in 3, 4, and 5 ton sizes and use R-410A refrigerant. They are designed for 208/230 volt 3-phase applications.

ASX, ASZ, DSX and DSZ R-410A model units use the Copeland Scroll "Ultratech" Series compressors which are specifically designed for R-410A refrigerant. These units also have Copeland® ComfortAlert diagnostics.

ANX, ANZ, GSX, GSZ, SSX, SSZ, VSX, and VSZ R-410A model units use a mix of Scroll and Energy Efficient compressors which are specifically designed for R-410A refrigerant. There are several design characteristics which are different from the traditional reciprocating and/or scroll compressors. "Ultratech" Series scroll compressors will not have a discharge thermostat. Some of the early model scroll compressors required discharge thermostat.

"Ultratech" Series scroll compressors use "POE" or polyolester oil which is NOT compatible with mineral oil based lubricants like 3GS. "POE" oil must be used if additional oil is required.

Coils And Blower Coils

MBR/MBE blower cabinets are designed to be used as a two-piece blower and coil combination. MBR/MBE/MBVC blower sections can be attached to cased evaporator coil. This two-piece arrangement allows for a variety of mix-matching possibilities providing greater flexibility. The MBE/MBVC blower cabinets use a variable speed motor that maintains a constant airflow with a higher duct static.

MBE blower cabinets are approved for applications with cooling coils of up to 0.8 inches W.C. external static pressure. The MBE models includes a feature that allows airflow to be changed by +10% or -15%. The MBVC models allow airflow trimming of +/-10%.

The MBR blower cabinet uses a PSC motor. It is approved for applications with cooling coils of up to 0.5 inches W.C. external static pressure.

The MBR/MBE blower cabinets with proper coil matches can be positioned for upflow, counterflow, horizontal right or horizontal left operation. All units are constructed with R-4.2 insulation. In areas of extreme humidity (greater than 80% consistently), insulate the exterior of the blower with insulation having a vapor barrier equivalent to ductwork insulation, providing local codes permit.

The CAUF, CAPF and CAPT coils are designed for upflow and counterflow applications. The CACF and CHPF coils are designed for horizontal applications.

AR*F, ASPF, ASUF, ASPT, AMST Multi-Position Air Handler

These one-piece multi-position air handlers are used with R-410A and are available in 2 to 5 ton sizes with optional 3 kW to 25kW electric heat kits available for field installation. The AR*F unit's blower design includes a PSC motor and is compatible with heat pumps and cooling applications. ASUF and ASPT units use an EEM blower motor and are compatible with heat pumps and cooling applications.

This appliance can be installed in the vertical or left horizontal position without modification. The horizontal right and downflow positions require product modification. This product is designed for zero inches (0 inches) clearance; however, adequate access for service or replacement must be considered without removing permanent structure. This unit can be installed on a platform when deemed necessary.

In an attic installation a secondary drain pan must be provided by the installer and placed under the entire unit with a separate drain line properly sloped and terminated in an area visible to the owner. This secondary drain pan is required in the event that there is a leak or main drain blockage. Closed cell insulation should be applied to the drain lines in unconditioned spaces where sweating may occur.

NOTE: Single piece air handlers are factory-sealed to achieve a 2% or less leakage rate at 1.0" water gauge external duct static pressure.

PRODUCT DESIGN

The ASX [16 & 18], ASZ [16 & 18], DSX[16 & 18] and DSZ [16 & 18] series split system units use a two-stage scroll compressor. The two-step modulator has an internal unloading mechanism that opens a bypass port in the first compression pocket, effectively reducing the displacement of the scroll. The opening and closing of the bypass port is controlled by an internal electrically operated solenoid.

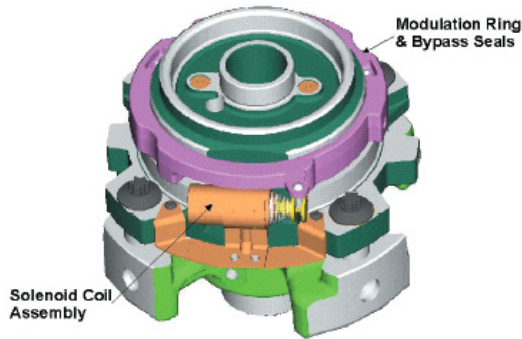

The ZPS/ZRS two-step modulated scroll uses a single step of unloading to go from full capacity to approximately 67% capacity. A single speed, high efficiency motor continues to run while the scroll modulates between the two capacity steps.

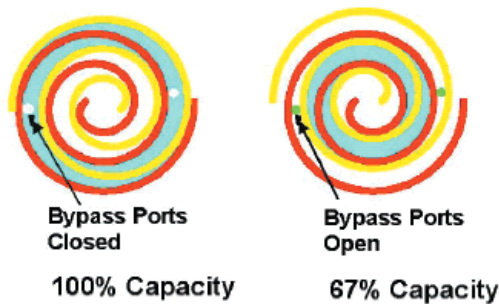

FIGURE A

A scroll is an involute spiral which, when matched with a mating scroll form as shown, generates a series of crescent shaped gas pockets between the two members.

During compression, one scroll remains stationary (fixed scroll) while the other form (orbiting scroll) is allowed to orbit (but not rotate) around the first form.



As this motion occurs, the pockets between the two forms are slowly pushed to the center of the two scrolls while simultaneously being reduced in volume. When the pocket reaches the center of the scroll form, the gas, which is now at a high pressure, is discharged out of a port located at the center.

During compression, several pockets are being compressed simultaneously, resulting in a very smooth process. Both the suction process (outer portion of the scroll members) and the discharge process (inner portion) are continuous.

Some design characteristics of the Compliant Scroll compressor are:

- Compliant Scroll compressors are more tolerant of liquid refrigerant.

NOTE: Even though the compressor section of a Scroll compressor is more tolerant of liquid refrigerant, continued floodback or flooded start conditions may wash oil from the bearing surfaces causing premature bearing failure.

- “Ultratech” Series scroll compressors use “POE” or polyolester oil which is NOT compatible with mineral oil based lubricants like 3GS. “POE” oil must be used if additional oil is required.
- Compliant scroll compressors perform “quiet” shutdowns that allow the compressor to restart immediately without the need for a time delay. This compressor will restart even if the system has not equalized.

NOTE: Operating pressures and amp draws may differ from standard reciprocating compressors. This information can be found in the unit’s Technical Information Manual.

Capacity Control - Legacy Models

During the compression process, there are several pockets within the scroll that are compressing gas. Modulation is achieved by venting a portion of the gas in the first suction pocket back to the low side of the compressor thereby reducing the effective displacement of the compressor. See Figure A. Full capacity is achieved by blocking these vents, increasing the displacement to 100%. A solenoid in the compressor, controlled by an external 24-volt ac signal, moves the slider ring that covers and uncovers these vents. The vent covers are arranged in such a manner that the compressor operates somewhere around 67% capacity when the solenoid is not energized and 100% capacity when the solenoid is energized. The loading and unloading of the two step scroll is done “on the fly” without shutting off the motor between steps. See Figure B below. The unloaded mode default was chosen for two reasons:

PRODUCT DESIGN

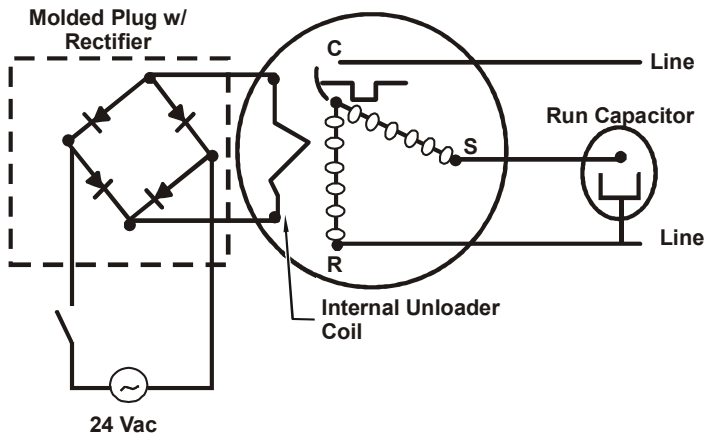

FIGURE B

1. It is expected that the majority of run hours will be in the low capacity, unloaded mode.
2. It allows a simple two-stage thermostat to control capacity through the second stage in both cooling and possibly heating if desired.

Unloader Solenoid

A nominal 24-volt direct current coil activates the internal unloader solenoid. The input control circuit voltage must be 18 to 28 volt ac. The coil power requirement is 20 VA. The external electrical connection is made with a molded plug assembly. This plug is connected to the Comfort Alert™ or CoreSense™ Module (dependent upon which module you are using) which contains a full wave rectifier to supply direct current to the unloader coil.

SYSTEM OPERATION

Cooling Cycle

For legacy room thermostat: When the room thermostat calls for cool, the contacts of the room thermostat close making terminals R to Y1 & G (if thermostat calls for low stage cool), or R to Y1, Y2 & G (if thermostat calls for high stage cool), the low voltage circuit of the transformer is completed. Current now flows through the magnetic holding coils of the compressor contactor (CC) and fan relay (RFC). If thermostat calls for high stage cool, the microprocessor on the UC board will also energize the compressor high stage solenoid to run the compressor at full capacity.

This draws in the normally open contact CC, starting the compressor and condenser fan motors in either low or high stage depending on the thermostat's demand. At the same time, contacts RFC close, starting the indoor fan motor. When the thermostat is satisfied, it opens its contacts, breaking the low voltage circuit, causing the compressor contactor and indoor fan relay to open, shutting down the system.

If the room thermostat fan selector switch should be set on the "on" position, then the indoor blower would run continuously rather than cycling with the compressor. GSZ, ANZ, ASZ, SSZ, DSZ, VSZ, GSZH5 and ASZH5 models energize the reversing valve through the "O" circuit in the room thermostat. Therefore, the reversing valve remains energized as long as the thermostat subbase is in the cooling position. The only exception to this is during defrost.

For heat pumps, during cooling cycle the reversing valve is energized as the room thermostat closes "O" terminal to R and the microprocessor on the UC board responds to such a condition by energizing the solenoid coil on the reversing valve.

Defrost Cycle

The defrosting of the outdoor coil is jointly controlled by the defrost control board and the defrost thermostat.

Solid State Defrost Control

During operation the power to the circuit board is controlled by a temperature sensor, which is clamped to a return bend (3/8" coils) or a feeder tube (5 mm coils) entering the outdoor coil. Defrost timing periods of 30, 60, or 90 minutes may be selected by connecting the circuit board jumper to 30, 60, or 90 respectively. Accumulation of time for the timing period selected starts when the sensor closes (approximately 31°F), and when the room thermostat calls for heat. At the end of the timing period, the unit's defrost cycle will be initiated provided the sensor remains closed. When the sensor opens (approximately 75°F), the defrost cycle is terminated and the timing period is reset. If the defrost cycle is not terminated due to the sensor temperature, a ten minute override interrupts the unit's defrost period. The new upgraded defrost control has a 12 minute override interrupt.

Cooling Cycle

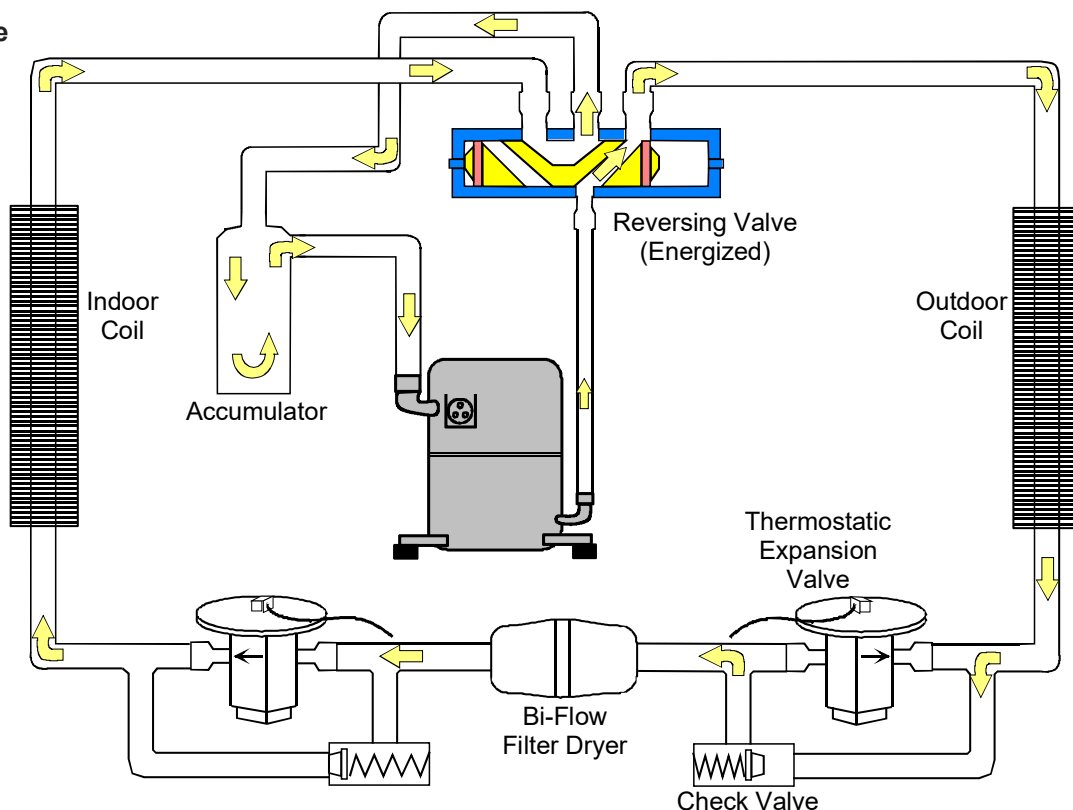

SYSTEM OPERATION

Heating Cycle

The reversing valve on the GSZ, SSZ, ANZ, ASZ, DSZ GSZH5 and ASZH5 models is energized in the cooling cycle through the "O" terminal on the room thermostat.

These models have a 24 volt reversing valve coil. When the thermostat selector switch is set in the cooling position, the "O" terminal on the thermostat is energized all the time.

Care must be taken when selecting a room thermostat. Refer to the installation instructions shipped with the product for approved thermostats.

When the room thermostat calls for heat, the contacts of the room thermostat close making terminals R to Y & G, the low voltage circuit of the transformer is completed. Current now flows through the magnetic holding coils of the compressor contactor (CC) and fan relay (RFC).

This draws in the normally open contact CC, starting the compressor condenser fan motors. At the same time, contacts RFC close, starting the indoor fan motor.

When the thermostat is satisfied, it opens its contacts, breaking the low voltage circuit, causing the compressor contactor and indoor fan relay to open, shutting down the system.

If the room thermostat fan selector switch should be set to the "on" position, then the indoor blower would run continuously rather than cycling with the compressor.

When the thermostat is satisfied, appropriate commands are sent to the UC control. The compressor relay and outdoor fan relay is de-energized. The compressor high stage solenoid is de-energized if it was energized. The UC control sends an appropriate command to the indoor unit to de-energize the indoor blower motor.

Heating Cycle

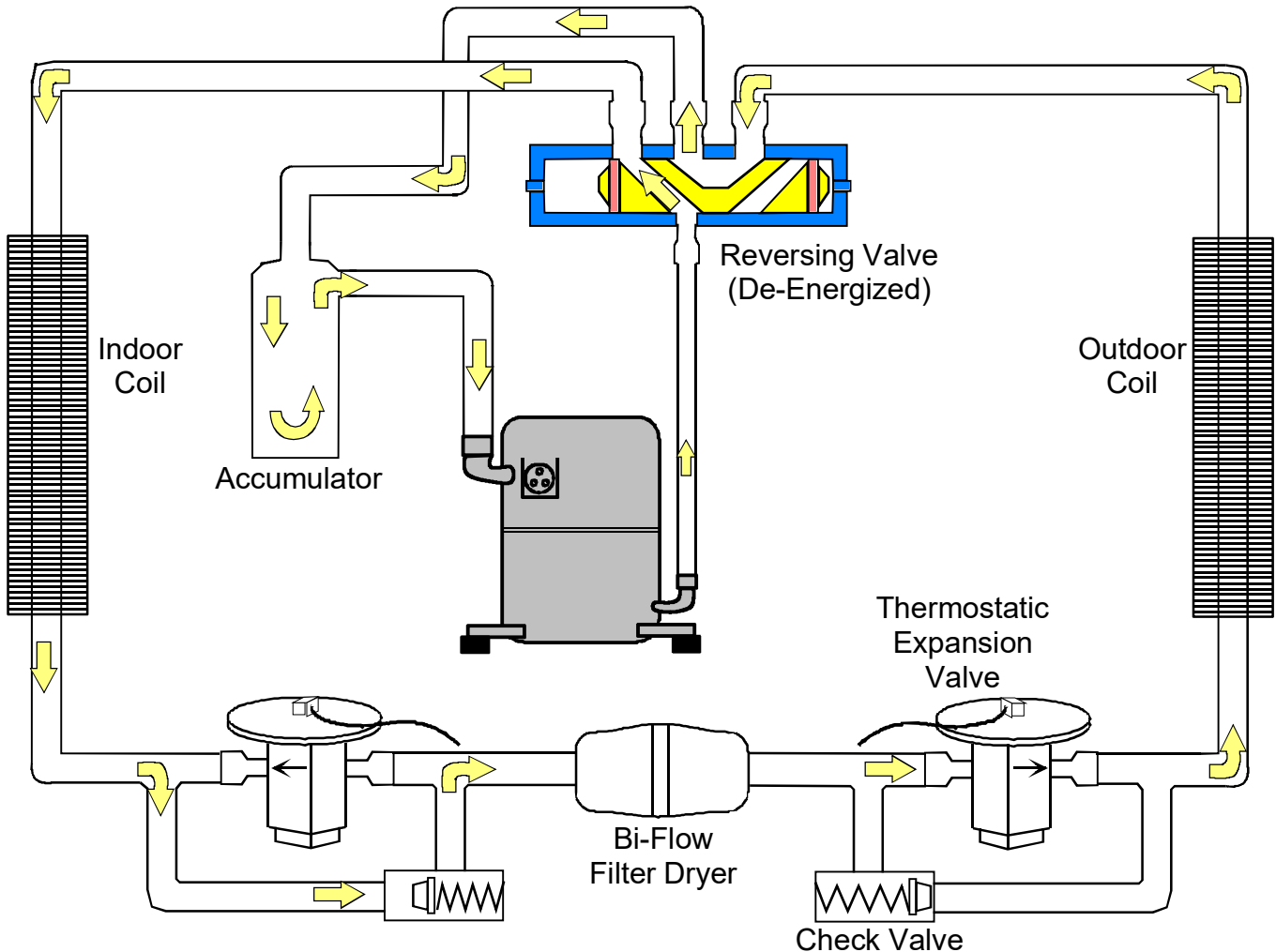

SYSTEM OPERATION

Expansion Valve/Check Valve Assembly In Cooling Operation

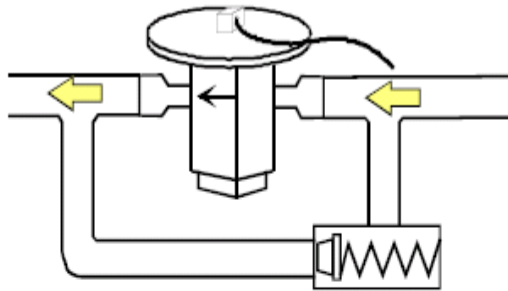

Expansion Valve/Check Valve Assembly In Heating Operation

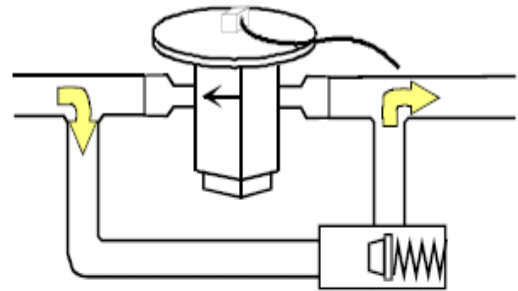

Most expansion valves used in current Amana Heat Pump products use an internally checked expansion valve. This type of expansion valve does not require an external check valve as shown above.

Restrictor Orifice Assy in Cooling Operation

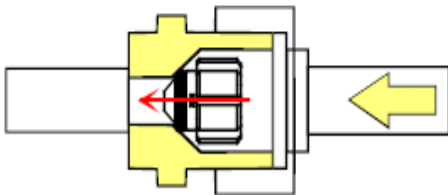

In the cooling mode, the orifice is pushed into its seat, forcing refrigerant to flow through the metered hole in the center of the orifice.

Restrictor Orifice Assy in Heating Operation

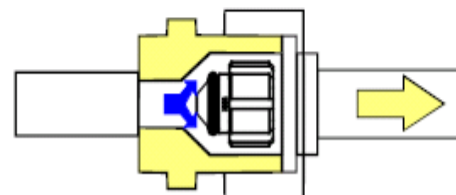

In the heating mode, the orifice moves back off its seat allowing refrigerant to flow unmetered around the outside of the orifice.

SEQUENCE OF OPERATION

Refer to the installation instructions and wiring diagrams provided with the MBR/AR*F for specific wiring connections and system configuration.

MBR/AR*F With Single Stage Condensers

1.0 Cooling Operation

1.1 On a demand for cooling, the room thermostat energizes “G” and “Y” and 24Vac is supplied to “Y” at the condensing unit and the “G” terminal on the EBTDR board.

1.2 The compressor and condenser fan are turned on and after a 7 second on delay, the relay on the EBTDR board is energized and the blower motor starts.

1.3 When the cooling demand “Y” is satisfied, the room thermostat removes the 24Vac from “G” and “Y”.

1.4 The compressor and condenser fan are turned off and after a 65 second delay off, the relay on the EBTDR board is de-energized and the blower is turned off.

2.0 Heating Operation

2.1 On a demand for heat, the room thermostat energizes “W1” and 24Vac is supplied to heat sequencer, HR1, on the heater assembly.

2.2 The contacts M1 and M2 will close within 10 to 20 seconds and turn on heater element #1. The normally closed contacts on the EBTDR are also connected to terminal M1. When M1 and M2 close, the blower motor will be energized thru the normally closed contacts on the EBTDR board. At the same time, if the heater assembly contains a second heater element, HR1 will contain a second set of contacts, M3 and M4, which will close to turn on heater element #2.

SYSTEM OPERATION

NOTE: If more than two heater elements are on the heater assembly, it will contain a second heat sequencer, HR2, which will control the 3rd and 4th heater elements if available. If the first stage heat demand, “W1” cannot be satisfied by the heat pump, the temperature indoors will continue to drop. The room thermostat will then energize “W2” and 24Vac will be supplied to HR2 on the heater assembly. When the “W2” demand is satisfied, the room thermostat will remove the 24Vac from HR2. The contacts on HR2 will open between 30 to 70 seconds and heater elements #3 and #4 will be turned off. On most digital/electronic thermostats, “W2” will remain energized until the first stage demand “W1” is satisfied and then the “W1” and “W2” demands will be removed.

2.3 When the “W1” heat demand is satisfied, the room thermostat will remove the 24Vac from HR1. Both set of contacts on the relay opens within 30 to 70 seconds and turn off the heater element(s) and the blower motor.

MBR/AR*F With Single Stage Heat Pumps

3.0 Cooling Operation

On heat pump units, when the room thermostat set to the cooling mode, 24Vac is supplied to “O” which energizes the reversing valve. As long as the thermostat is set for cooling, the reversing valve will be in the energized position for cooling.

3.1 On a demand for cooling, the room thermostat energizes “G” and “Y” and 24Vac is supplied to “Y” at the heat pump and the “G” terminal on the EBTD board.

3.2 The heat pump turned on in the cooling mode and after a 7 second on delay, the relay on the EBTD board is energized and the blower motor starts.

3.3 When the cooling demand is satisfied, the room thermostat removes the 24Vac from “G” and “Y”.

3.4 The heat pump is turned off and after a 65 second delay off, the relay on the EBTD board is de-energized and the blower motor is turned off.

4.0 Heating Operation

On heat pump units, when the room thermostat set to the heating mode, the reversing valve is not energized. As long as the thermostat is set for heating, the reversing valve will be in the de-energized position for heating except during a defrost cycle. Some installations may use one or more outdoor thermostats to restrict the amount of electric heat that is available above a preset ambient temperature. Use of optional controls such as these can change the operation of the electric heaters during the heating mode. This sequence of operation does not cover those applications.

4.1 On a demand for first stage heat with heat pump units, the room thermostat energizes “G” and “Y” and 24Vac is supplied to “Y” at the heat pump unit and the “G” terminal on the EBTD board. The heat pump is turned on in the heating mode and the blower motor starts after a 7 second on delay.

4.2 If the first stage heat demand cannot be satisfied by the heat pump, the temperature indoors will continue to drop. The room thermostat will then energize terminal “W2” for second stage heat and 24Vac will be supplied to heat sequencer HR1 on the heater assembly.

4.3 HR1 contacts M1 and M2 will close will close within 10 to 20 seconds and turn on heater element #1. At the same time, if the heater assembly contains a second heater element, HR1 will contain a second set of contacts, M3 and M4, which will close and turn on heater element #2. The blower motor is already on as a result of terminal “G” on the EBTD board being energized for the first stage heat demand.

NOTE: If more than two heater elements are on the heater assembly, it will contain a second heat sequencer, HR2, which will control the 3rd and 4th heater elements if available. If the second stage heat demand, “W2” cannot be satisfied by the heat pump, the temperature indoors will continue to drop. The room thermostat will then energize “W3” and 24Vac will be supplied to HR2 on the heater assembly. When the “W3” demand is satisfied, the room thermostat will remove the 24Vac from HR2. The contacts on HR2 will open between 30 to 70 seconds and heater elements #3 and #4 will be turned off. On most digital/electronic thermostats, “W3” will remain energized until the first stage heat demand “Y” is satisfied and then the “G”, “Y”, “W2” and “W3” demands will be removed.

4.4 As the temperature indoors increase, it will reach a point where the second stage heat demand, “W2”, is satisfied. When this happens, the room thermostat will remove the 24Vac from the coil of HR1. The contacts on HR1 will open between 30 to 70 seconds and turn off both heater element(s). The heat pump remains on along with the blower motor because the “Y” demand for first stage heat will still be present.

4.5 When the first stage heat demand “Y” is satisfied, the room thermostat will remove the 24Vac from “G” and “Y”. The heat pump is turned off and the blower motor turns off after a 65 second off delay.

5.0 Defrost Operation

On heat pump units, when the room thermostat is set to the heating mode, the reversing valve is not energized.

SYSTEM OPERATION

As long as the thermostat is set for heating, the reversing valve will be in the de-energized position for heating except during a defrost cycle.

5.1 The heat pump will be on and operating in the heating mode as described the Heating Operation in section 4.

5.2 The defrost control in the heat pump unit checks to see if a defrost is needed every 30, 60 or 90 minutes of heat pump operation depending on the selectable setting by monitoring the state of the defrost thermostat attached to the outdoor coil.

5.3 If the temperature of the outdoor coil is low enough to cause the defrost thermostat to be closed when the defrost board checks it, the board will initiate a defrost cycle.

5.4 When a defrost cycle is initiated, the contacts of the HVDR relay on the defrost board open and turns off the outdoor fan. The contacts of the LVDR relay on the defrost board closes and supplies 24Vac to “O” and “W2”. The reversing valve is energized and the contacts on HR1 close and turns on the electric heater(s). The unit will continue to run in this mode until the defrost cycle is completed.

5.4a For models with defrost control PCBDM133 or PCBDM160, a 30 second compressor delay at defrost initiation/termination is optional. As shipped from the factory, the control is set for the delay (“DLY”), which will turn the compressor off for 30 seconds while the reversing valve shifts to/from the cooling mode position. To bypass the delay, which typically reduces sound levels during defrost mode, change the pin settings from “DLY” to “NORM”.

5.5 When the temperature of the outdoor coil rises high enough to causes the defrost thermostat to open, the defrost cycle will be terminated. If at the end of the programmed 10 minute override time the defrost thermostat is still closed, the defrost board will automatically terminate the defrost cycle.

5.6 When the defrost cycle is terminated, the contacts of the HVDR relay will close to start the outdoor fan and the contacts of the LVDR relay will open and turn off the reversing valve and electric heater(s). The unit will now be back in a normal heating mode with a heat pump demand for heating as described in the Heating Operation.

MBE/AEPF With GSX, SSX, ANX, ASX, DSX, VSX MBE Electronic Blower Time Delay Relay AEPF Air Handler

SEQUENCE OF OPERATION

This document covers the basic sequence of operation for a typical application with a mercury bulb thermostat. When a digital/electronic thermostat is used, the on/off staging of the auxiliary heat will vary. Refer to the installation instructions and wiring diagrams provided with the MBE/AEPF for specific wiring connections, dip switch settings and system configuration.

MBE/AEPF With Single Stage GSX, ANX, ASX, SSX, And VSX Condensers

When used with a single stage GSX, SSX, ASX, and VSX condensers, dip switch #4 must be set to the on position on the VSTB inside the MBE/AEPF. The “Y” output from the indoor thermostat must be connected to the yellow wire labeled “Y/Y2” inside the wire bundle marked “Thermostat” and the yellow wire labeled “Y/Y2” inside the wire bundle marked “Outdoor Unit” must be connected to “Y” at the condenser. The orange jumper wire from terminal “Y1” to terminal “O” on the VSTB inside the MBE/AEPF must remain connected.

1.0 Cooling Operation

1.1 On a demand for cooling, the room thermostat energizes “G” and “Y” and 24Vac is supplied to “G” and “Y/Y2” of the MBE/AEPF unit. The VSTB inside the MBE/AEPF will turn on the blower motor and the motor will ramp up to the speed programmed in the motor based on the settings for dip switch 5 and 6. The VSTB will supply 24Vac to “Y” at the condenser and the compressor and condenser are turned on.

1.2 When the cooling demand is satisfied, the room thermostat removes the 24Vac from “G” and “Y”. The MBE/AEPF removes the 24Vac from “Y” at the condenser and the compressor and condenser fan are turned off. The blower motor will ramp down to a complete stop based on the time and rate programmed in the motor.

2.0 Heating Operation

2.1 On a demand for heat, the room thermostat energizes “W1” and 24Vac is supplied to terminal “E/W1” of the VSTB inside the MBE/AEPF unit. The VSTB will turn on the blower motor and the motor will ramp up to the speed programmed in the motor based on the settings for dip switch 1 and 2. The VSTB will supply 24Vac to heat sequencer HR1 on the electric heater assembly.

2.2 HR1 contacts M1 and M2 will close within 10 to 20 seconds and turn on heater element #1. At the same time, if the heater assembly contains a second heater element, HR1 will contain a second set of contacts, M3 and M4, which will close and turn on heater element #2.

SYSTEM OPERATION

NOTE: If more than two heater elements are on the heater assembly, it will contain a second heat sequencer, HR2, which will control the 3rd and 4th heater elements if available. For the 3rd and 4th heater elements to operate on a second stage heat demand, the PJ4 jumper on the VSTB inside the MBE/AEPF must be cut. With the PJ4 jumper cut, the VSTB will run the blower motor on low speed on a “W1” only demand. If the first stage heat demand, “W1” cannot be satisfied by the heat pump, the temperature indoors will continue to drop. The room thermostat will then energize “W2” and 24Vac will be supplied to HR2 on the heater assembly and the blower motor will change to high speed. When the “W2” demand is satisfied, the room thermostat will remove the 24Vac from “W2” and the VSTB will remove the 24Vac from HR2. The contacts on HR2 will open between 30 to 70 seconds and heater elements #3 and #4 will be turned off and the blower motor will change to low speed. On most digital/electronic thermostats, “W2” will remain energized until the first stage demand “W1” is satisfied and then the “W1” and “W2” demands will be removed.

2.3 When the “W1” heat demand is satisfied, the room thermostat will remove the 24Vac from “E/W1” and the VSTB between 30 to 70 seconds and turn off the heater element(s) and the blower motor ramps down to a complete stop.

MBE/AEPF With Single Stage GSZ, SSZ, ANZ, ASZ, and VSZ Heat Pumps

When used with a single stage GSZ, SSZ, ASZ, or VSZ heat pumps, dip switch #4 must be set to the ON position on the VSTB inside the MBE. The “Y” output from the indoor thermostat must be connected to the yellow wire labeled “Y/Y2” inside the wire bundle marked “Thermostat” and the yellow wire labeled “Y/Y2” inside the wire bundle marked “Outdoor Unit” must be connected to “Y” at the heat pump. **The orange jumper wire from terminal “Y1” to terminal “O” on the VSTB inside the MBE/AEPF must be removed.**

3.0 Cooling Operation

On heat pump units, when the room thermostat is set to the cooling mode, 24Vac is supplied to terminal “O” of the VSTB inside the MBE/AEPF unit. The VSTB will supply 24Vac to “O” at the heat pump to energize the reversing valve. As long as the thermostat is set for cooling, the reversing valve will be in the energized position for cooling.

3.1 On a demand for cooling, the room thermostat energizes “G” and “Y” and 24Vac is supplied to terminals “G” and “Y/Y2” of the MBE/AEPF unit. The VSTB will turn on the blower motor and the motor will ramp up to the speed programmed in the motor based on the settings of dip switch 5 and 6. The VSTB will supply 24Vac to “Y” at the heat pump.

3.2 The heat pump is turned on in the cooling mode.

3.3 When the cooling demand is satisfied, the room thermostat removes the 24Vac from “G” and “Y/Y2” of the MBE/AEPF and the VSTB removes the 24Vac from “Y” at the heat pump. The heat pump is turned off and the blower motor will ramp down to a complete stop based on the time and rate programmed in the motor.

4.0 Heating Operation

On heat pump units, when the room thermostat is set to the heating mode, the reversing valve is not energized. As long as the thermostat is set for heating, the reversing valve will be in the de-energized position for heating except during a defrost cycle. Some installations may use one or more outdoor thermostats to restrict the amount of electric heat that is available above a preset ambient temperature. Use of optional controls such as these can change the operation of the electric heaters during the heating mode. This sequence of operation does not cover those applications.

4.1 On a demand for first stage heat with heat pump units, the room thermostat energizes “Y” and “G” and 24Vac is supplied to “G” and “Y/Y2” of the MBE/AEPF. The VSTB will turn on the blower motor and the motor will ramp up to the speed programmed in the motor based on the settings of dip switch 1 and 2. The VSTB will supply 24Vac to “Y” at the heat pump and the heat pump is turned on in the heating mode.

4.2 If the first stage heat demand cannot be satisfied by the heat pump, the temperature indoors will continue to drop. The room thermostat will then energize terminal “W2” for second stage heat and 24Vac will be supplied to “E/W1” of the MBE/AEPF. The VSTB will supply 24Vac to heat sequencer, HR1, on the electric heater assembly.

4.3 HR1 contacts M1 and M2 will close within 10 to 20 seconds and turn on heater element #1. At the same time, if the heater assembly contains a second heater element, HR1 will contain a second set of contacts, M3 and M4, which will close to turn on heater element #2.

SYSTEM OPERATION

NOTE: If more than two heater elements are on the heater assembly, it will contain a second heat sequencer, HR2, which will control the 3rd and 4th heater elements if available. For the 3rd and 4th heater elements to operate on a third stage heat demand, the PJ4 jumper on the VSTB inside the MBE/AEPF must be cut. If the second stage heat demand, “W2”, cannot be satisfied by the heat pump, the temperature indoors will continue to drop. The room thermostat will then energize “W3” and 24Vac will be supplied to “W/W2” of the MBE/AEPF. The VSTB will supply 24Vac to HR2 on the electric heater assembly. When the “W3” demand is satisfied, the room thermostat will remove the 24Vac from “W/W2” of the MBE/AEPF. The contacts on HR2 will open between 30 to 70 seconds and heater elements #3 and #4 will be turned off. On most digital/electronic thermostats, “W3” will remain energized until the first stage demand “Y” is satisfied and then the “G”, “Y”, “W2” and “W3” demands will be removed.

4.4 As the temperature indoors increase, it will reach a point where the second stage heat demand, “W2”, is satisfied. When this happens, the room thermostat will remove the 24Vac from “E/W1” of the MBE/AEPF. The contacts on HR1 will open between 30 to 70 seconds and turn off both heater element(s). The heat pump remains on along with the blower motor because the “Y” demand for first stage heat will still be present.

4.5 When the first stage heat demand “Y” is satisfied, the room thermostat will remove the 24Vac from “G” and “Y/Y2” of the MBE/AEPF. The VSTB removes the 24Vac from “Y” at the heat pump and the heat pump is turned off. The blower motor will ramp down to a complete stop based on the time and rate programmed in the motor control.

5.0 Defrost Operation

On heat pump units, when the room thermostat is set to the heating mode, the reversing valve is not energized. As long as the thermostat is set for heating, the reversing valve will be in the de-energized position for heating except during a defrost cycle.

5.1 The heat pump will be on and operating in the heating mode as described the Heating Operation in section 4.

5.2 The defrost control in the heat pump unit checks to see if a defrost is needed every 30, 60 or 90 minutes of heat pump operation depending on the selectable setting by monitoring the state of the defrost thermostat attached to the outdoor coil.

5.3 If the temperature of the outdoor coil is low enough to cause the defrost thermostat to be closed when the defrost board checks it, the board will initiate a defrost cycle.

5.4 When a defrost cycle is initiated, the contacts of the HVDR relay on the defrost board open and turns off the outdoor fan.

The contacts of the LVDR relay on the defrost board closes and supplies 24Vac to “O” and “W2”. The reversing valve is energized and the contacts on HR1 close and turns on the electric heater(s). The unit will continue to run in this mode until the defrost cycle is completed.

5.4a For models with defrost control PCBDM133 or PCBDM160, a 30 second compressor delay at defrost initiation/termination is optional. As shipped from the factory, the control is set for the delay (“DLY”), which will turn the compressor off for 30 seconds while the reversing valve shifts to/from the cooling mode position. To bypass the delay, which typically reduces sound levels during defrost mode, change the pin settings from “DLY” to “NORM”.

5.5 When the temperature of the outdoor coil rises high enough to causes the defrost thermostat to open, the defrost cycle will be terminated. If at the end of the programmed 10 minute override time the defrost thermostat is still closed, the defrost board will automatically terminate the defrost cycle.

5.6 When the defrost cycle is terminated, the contacts of the HVDR relay on the defrost board will close to start the outdoor fan and the contacts of the LVDR relay will open and turn off the reversing valve and electric heater(s). The unit will now be back in a normal heating mode with a heat pump demand for heating as described in the Heating Operation in section 4. See section 5.4a.

MBE/AEPF With Two Stage ASX & DSX Condensers

1.0 Cooling Operation

When used with the ASX & DSX two stage condensers, dip switch #4 must be set to the OFF position on the VSTB inside the MBE/AEPF. The “Y1” output from the indoor thermostat must be connected to the purple wire labeled “Ylow/Y1” inside the wire bundle marked “Thermostat” and the purple wire labeled “Ylow/Y1” inside the wire bundle marked “Outdoor Unit” must be connected to “Ylow/Y1” at the condenser. The “Y2” output from the indoor thermostat must be connected to the yellow wire labeled “Y/Y2” inside the wire bundle marked “Thermostat” and the yellow wire labeled “Y/Y2” inside the wire bundle marked “Outdoor Unit” must be connected to “Y/Y2” at the condenser. The orange jumper wire from terminal “Y1” to terminal “O” on the VSTB inside the MBE/AEPF must remain connected.

SYSTEM OPERATION

1.1 On a demand for cooling, the room thermostat energizes “G” and “Y1” and 24Vac is supplied to “G” and “Ylow/Y1” of the MBE/AEPF unit. The VSTB inside the MBE/AEPF will turn on the blower motor and the motor will ramp up to 60% of the speed programmed in the motor based on the settings for dip switch 5 and 6. The VSTB will supply 24Vac to “Ylow/Y1” at the condenser and the compressor and condenser fan starts in low speed operation.

1.2 If first stage cooling cannot satisfy the demand, the room thermostat will energize “Y2” and supply 24Vac to the MBE/AEPF unit. The blower motor will change to the cfm for high speed operation and the VSTB will supply 24Vac to “Y/Y2” at the condenser and the compressor and condenser fan will change to high speed operation. When the “Y2” demand is satisfied, the thermostat will remove the “Y2” demand and the VSTB will remove the 24Vac from “Y/Y2” at the condenser.

The blower will drop to 60% of the programmed cfm and the compressor and condenser fan will change to low speed. **On most digital/electronic thermostats, “Y2” will remain energized until the first stage cooling demand “Y1” is satisfied and then the “G”, “Y1” and “Y2” demands will be removed.**

1.3 When the first stage cooling demand, “Y1”, is satisfied, the room thermostat removes the 24Vac from “G” and “Y1”. The MBE/AEPF removes the 24Vac from “Ylow/Y1” at the condenser and the compressor and condenser fan are turned off. The blower motor will ramp down to a complete stop based on the time and rate programmed in the motor.

2.0 Heating Operation

2.1 On a demand for heat, the room thermostat energizes “W1” and 24Vac is supplied to terminal “E/W1” of the VSTB inside the MBE/AEPF unit. The VSTB will turn on the blower motor and the motor will ramp up to the speed programmed in the motor based on the settings for dip switch 1 and 2. The VSTB will supply 24Vac to heat sequencer HR1 on the electric heater assembly.

2.2 HR1 contacts M1 and M2 will close within 10 to 20 seconds and turn on heater element #1. At the same time, if the heater assembly contains a second heater element, HR1 will contain a second set of contacts, M3 and M4, which will close and turn on heater element #2.

NOTE: If more than two heater elements are on the heater assembly, it will contain a second heat sequencer, HR2, which will control the 3rd and 4th heater elements if available. For the 3rd and 4th heater elements to operate on a second stage heat

demand, the PJ4 jumper on the VSTB inside the MBE/AEPF must be cut. With the PJ4 jumper cut, the VSTB will run the blower motor on low speed on a “W1” only demand. If the first stage heat demand, “W1” cannot be satisfied by the heat pump, the temperature indoors will continue to drop. The room thermostat will then energize “W2” and 24Vac will be supplied to HR2 on the heater assembly and the blower motor will change to high speed. When the “W2” demand is satisfied, the room thermostat will remove the 24Vac from “W2” and the VSTB will remove the 24Vac from HR2. The contacts on HR2 will open between 30 to 70 seconds and heater elements #3 and #4 will be turned off and the blower motor will change to low speed. On most digital/electronic thermostats, “W2” will remain energized until the first stage demand “W1” is satisfied and then the “W1” and “W2” demands will be removed.

2.3 When the “W1” heat demand is satisfied, the room thermostat will remove the 24Vac from “E/W1” and the VSTB removes the 24Vac from HR1. The contacts on HR1 will open between 30 to 70 seconds and turn off the heater element(s) and the blower motor ramps down to a complete stop.

MBE/AEPF With Two Stage ASZ & DSZ Heat Pump Units

3.0 Cooling Operation

When used with the ASZ & DSZ two stage heat pumps, dip switch #4 must be set to the OFF position on the VSTB inside the MBE/AEPF. The “Y1” output from the indoor thermostat must be connected to the purple wire labeled “Ylow/Y1” inside the wire bundle marked “Thermostat” and the purple wire labeled “Ylow/Y1” inside the wire bundle marked “Outdoor Unit” must be connected to “Y” at the heat pump. The “Y2” output from the indoor thermostat must be connected to the yellow wire labeled “Y/Y2” inside the wire bundle marked “Thermostat” and the yellow wire labeled “Y/Y2” inside the wire bundle marked “Outdoor Unit” must be connected to “Y/Y2” at the heat pump. **The orange jumper wire from terminal “Y1” to terminal “O” on the VSTB inside the MBE/AEPF must be removed.**

On heat pump units, when the room thermostat is set to the cooling mode, 24Vac is supplied to terminal “O” of the VSTB inside the MBE unit. The VSTB will supply 24Vac to “O” at the heat pump to energize the reversing valve. As long as the thermostat is set for cooling, the reversing valve will be in the energized position for cooling.

SYSTEM OPERATION

3.1 On a demand for cooling, the room thermostat energizes “G” and “Y1” and 24Vac is supplied to “G” and “Ylow/Y1” of the MBE unit. The VSTB inside the MBE will turn on the blower motor and the motor will ramp up to 60% of the speed programmed in the motor based on the settings for dip switch 5 and 6. The VSTB will supply 24Vac to “Y” at the heat pump and the compressor and outdoor fan starts in low speed operation.

3.2 If first stage cooling cannot satisfy the demand, the room thermostat will energize “Y2” and supply 24Vac to “YY2” of the MBE unit. The blower motor will change to the cfm for high speed operation and the VSTB will supply 24Vac to “Y2” at the heat pump. The compressor and outdoor fan will change to high speed operation. When the “Y2” demand is satisfied, the thermostat will remove the “Y2” demand and the VSTB will remove the 24Vac from “Y2” at the heat pump. The blower will drop to 60% of the programmed cfm and the compressor and outdoor fan will change to low speed operation. **On most digital/electronic thermostats, “Y2” will remain energized until the first stage cooling demand “Y1” is satisfied and then the “G”, “Y1” and “Y2” demands will be removed.**

3.3 When the first stage cooling demand, “Y1”, is satisfied, the room thermostat removes the 24Vac from “G” and “Y1”. The VSTB removes the 24Vac from “Y” at the heat pump and the compressor and outdoor fan are turned off. The blower motor will ramp down to a complete stop based on the time and rate programmed in the motor.

4.0 Heating Operation

On heat pump units, when the room thermostat is set to the heating mode, the reversing valve is not energized. As long as the thermostat is set for heating, the reversing valve will be in the de-energized position for heating except during a defrost cycle. Some installations may use one or more outdoor thermostats to restrict the amount of electric heat that is available above a preset ambient temperature. Use of optional controls such as these can change the operation of the electric heaters during the heating mode. This sequence of operation does not cover those applications.

4.1 On a demand for first stage heat with heat pump units, the room thermostat energizes “G” and “Y1” and 24Vac is supplied to “G” and “Ylo/Y1” of the MBE/AEPF. The VSTB will turn on the blower motor and the motor will ramp up to 60% of the speed programmed in the motor based on the settings of dip switch 1 and 2. The VSTB will supply 24Vac to “Y” at the heat pump. **The compressor will start on low stage and outdoor fan will start on low speed on a “Y1” heating demand but the blower motor will deliver only 60% of the programmed cfm for high speed heating operation.**

4.2 If a thermostat that provides a “Y2” demand in heating is used and first stage heating cannot satisfy the demand, the room thermostat will energize “Y2” and supply 24Vac to “Y/Y2” of the MBE unit. The blower motor will change to the cfm for high speed heating operation and the VSTB will supply 24Vac to “Y/Y2” at the heat pump. The outdoor fan will change to high speed operation and compressor will shift to high stage. If the “Y2” demand is present and becomes satisfied, the thermostat will remove the “Y2” demand and the VSTB will remove the 24Vac from “Y/Y2” at the heat pump. The blower will drop to 60% of the programmed cfm and the outdoor fan will change to low speed. On most digital/electronic thermostats, “Y2” will remain energized until the first stage heating demand “Y1” is satisfied and then the “G”, “Y1” and “Y2” demands will be removed.

4.3 If the heat pump operation cannot satisfy the demand, the room thermostat energizes “W2/W3” and 24Vac is supplied to terminal “E/W1” of the VSTB inside the MBE/AEPF unit. The VSTB will supply 24Vac to heat sequencer HR1 on the electric heater assembly.

4.4 HR1 contacts M1 and M2 will close within 10 to 20 seconds and turn on heater element #1. At the same time, if the heater assembly contains a second heater element, HR1 will contain a second set of contacts, M3 and M4, which will close and turn on heater element #2.

NOTE: If more than two heater elements are on the heater assembly, it will contain a second heat sequencer, HR2, which will control the 3rd and 4th heater elements if available. For the 3rd and 4th heater elements to operate on a second stage auxiliary heat demand, the PJ4 jumper on the VSTB inside the MBE/AEPF must be cut. If the “W2/W3” demand cannot be satisfied by the heat pump, the temperature indoors will continue to drop. The room thermostat will then energize “W3/W4” and 24Vac will be supplied to “W/W2” of the MBE. The VSTB will supply 24Vac to HR2 on the electric heater assembly. When the “W3/W4” demand is satisfied, the room thermostat will remove the 24Vac from “W/W2” of the MBE/AEPF. The contacts on HR2 will open between 30 to 70 seconds and heater elements #3 and #4 will be turned off. On most digital/electronic thermostats, “W3/W4” will remain energized until the first stage demand “Y1” is satisfied and then the “G”, “Y1”, “Y2”, “W2/W3” and “W3/W4” demands will be removed.

SYSTEM OPERATION

4.5 As the temperature indoors increase, it will reach a point where the “W2/W3” demand is satisfied. When this happens, the room thermostat will remove the 24Vac from “E/W1” of the MBE/AEPF. The contacts on HR1 will open between 30 to 70 seconds and turn off the 1st and 2nd heater elements. If the “Y2” demand is present and becomes satisfied the room thermostat will remove the 24Vac from “Y/Y2” of the MBE and the blower motor will change to 60% of the programmed cfm. The VSTB will remove the 24Vac from “Y/Y2” at the heat pump and the outdoor fan will change to low speed operation. The heat pump remains on along with the blower motor because the “Y1” demand for first stage heat will still be present.

4.6 When the first stage heat demand “Y1” is satisfied, the room thermostat will remove the 24Vac from “G” and “Ylo/Y1” of the MBE/AEPF. The VSTB removes the 24Vac from “Ylo/Y1” at the heat pump and the compressor and outdoor fan are turned off. The blower motor will ramp down to a complete stop based on the time and rate programmed in the motor control.

5.0 Defrost Operation

On heat pump units, when the room thermostat is set to the heating mode, the reversing valve is not energized. As long as the thermostat is set for heating, the reversing valve will be in the de-energized position for heating except during a defrost cycle.

5.1 The heat pump will be on and operating in the heating mode as described the Heating Operation in section 4.

5.2 The defrost control in the heat pump unit checks to see if a defrost is needed every 30, 60 or 90 minutes of heat pump operation depending on the selectable setting by monitoring the state of the defrost thermostat attached to the outdoor coil.

5.3 If the temperature of the outdoor coil is low enough to cause the defrost thermostat to be closed when the defrost board checks it, the board will initiate a defrost cycle.

5.4 When a defrost cycle is initiated, the contacts of the HVDR relay on the defrost board open and turns off the outdoor fan. The contacts of the LVDR relay on the defrost board closes and supplies 24Vac to “O” and “W2”. The reversing valve is energized and the contacts on HR1 close and turns on the electric heater(s). The unit will continue to run in this mode until the defrost cycle is completed.

5.4a For models with defrost control PCBDM133 or PCBDM160, a 30 second compressor delay at defrost initiation/termination is optional. As shipped from the factory, the control is set for the delay (“DLY”), which will turn the compressor off for 30 seconds while the reversing valve shifts to/from the cooling mode position. To bypass the delay, which typically reduces sound levels during defrost mode, change the pin settings from “DLY” to “NORM”.

5.5 When the temperature of the outdoor coil rises high enough to causes the defrost thermostat to open, the defrost cycle will be terminated. If at the end of the programmed 10 minute override time the defrost thermostat is still closed, the defrost board will automatically terminate the defrost cycle.

SERVICING

Checking Voltage

1. Remove outer case, control panel cover, etc., from unit being tested.

With power ON:

 WARNING
LINE VOLTAGE NOW PRESENT.

2. Using a voltmeter, measure the voltage across terminals L1 and L2 of the contactor for the condensing unit or at the field connections for the air handler or heaters.
3. No reading - indicates open wiring, open fuse(s) no power or etc., from unit to fused disconnect service. Repair as needed.
4. With ample voltage at line voltage connectors, energize the unit.
5. Measure the voltage with the unit starting and operating, and determine the unit Locked Rotor Voltage.

NOTE: If checking heaters, be sure all heating elements are energized.

Locked Rotor Voltage is the actual voltage available at the compressor during starting, locked rotor, or a stalled condition. Measured voltage should be above minimum listed in chart below.

To measure Locked Rotor Voltage attach a voltmeter to the run "R" and common "C" terminals of the compressor, or to the T1 and T2 terminals of the contactor. Start the unit and allow the compressor to run for several seconds, then shut down the unit. Immediately attempt to restart the unit while measuring the Locked Rotor Voltage.

6. Locked rotor voltage should read within the voltage tabulation as shown. If the voltage falls below the minimum voltage, check the line wire size. Long runs of undersized wire can cause low voltage. If wire size is adequate, notify the local power company in regard to either low or high voltage.

Unit Supply Voltage		
Voltage	Min.	Max
208/230	197	253
460	414	506

NOTE: When operating electric heaters on voltages other than 240 volts, refer to the System Operation section on electric heaters to calculate temperature rise and air flow. Low voltage may cause insufficient heating.

Checking Wiring

 WARNING
HIGH VOLTAGE! DISCONNECT ALL POWER BEFORE SERVICING OR INSTALLING. MULTIPLE POWER SOURCES MAY BE PRESENT. FAILURE TO DO SO MAY CAUSE PROPERTY DAMAGE, PERSONAL INJURY OR DEATH.



1. Check wiring visually for signs of overheating, damaged insulation and loose connections.
2. Use an ohmmeter to check continuity of any suspected open wires.
3. If any wires must be replaced, replace with comparable gauge and insulation thickness.

Checking Thermostat And Wiring

Thermostat Wiring: The maximum wire length for 18 AWG thermostat wire is 100 feet.

Thermostat Wiring

 WARNING
LINE VOLTAGE NOW PRESENT.

With power ON, thermostat calling for cooling

1. Use a voltmeter to check for 24 volts at thermostat wires C and Y in the condensing unit control panel.
2. No voltage indicates trouble in the thermostat, wiring or external transformer source.
3. Check the continuity of the thermostat and wiring. Repair or replace as necessary.

Indoor Blower Motor

With power ON:

 WARNING
LINE VOLTAGE NOW PRESENT.

1. Set fan selector switch at thermostat to "ON" position.
2. With voltmeter, check for 24 volts at wires C and G.
3. No voltage indicates the trouble is in the thermostat or wiring.
4. Check the continuity of the thermostat and wiring. Repair or replace as necessary.



SERVICING

Resistance Heaters

1. Set room thermostat to a higher setting than room temperature so both stages call for heat.
2. With voltmeter, check for 24 volts at each heater relay.
3. No voltage indicates the trouble is in the thermostat or wiring.
4. Check the continuity of the thermostat and wiring. Repair or replace as necessary.

NOTE: Consideration must be given to how the heaters are wired (O.D.T. and etc.). Also safety devices must be checked for continuity.

Checking Transformer And Control Circuit

 WARNING	
HIGH VOLTAGE! DISCONNECT ALL POWER BEFORE SERVICING OR INSTALLING. MULTIPLE POWER SOURCES MAY BE PRESENT. FAILURE TO DO SO MAY CAUSE PROPERTY DAMAGE, PERSONAL INJURY OR DEATH.	

A step-down transformer (208/240 volt primary to 24 volt secondary) is provided with each indoor unit. This allows ample capacity for use with resistance heaters. The outdoor sections do not contain a transformer (see note below).

 WARNING
DISCONNECT ALL POWER BEFORE SERVICING.



1. Remove control panel cover, or etc., to gain access to transformer.

With power ON:

 WARNING
LINE VOLTAGE NOW PRESENT.

2. Using a voltmeter, check voltage across secondary voltage side of transformer (R to C).
3. No voltage indicates faulty transformer, bad wiring, or bad splices.
4. Check transformer primary voltage at incoming line voltage connections and/or splices.
5. If line voltage available at primary voltage side of transformer and wiring and splices good, transformer is inoperative. Replace.

Checking Contactor And/Or Relays

 WARNING	
HIGH VOLTAGE! DISCONNECT ALL POWER BEFORE SERVICING OR INSTALLING. MULTIPLE POWER SOURCES MAY BE PRESENT. FAILURE TO DO SO MAY CAUSE PROPERTY DAMAGE, PERSONAL INJURY OR DEATH.	

The compressor contactor and other relay holding coils are wired into the low or line voltage circuits. When the control circuit is energized, the coil pulls in the normally open contacts or opens the normally closed contacts. When the coil is de-energized, springs return the contacts to their normal position.

Checking Contactor Contacts

 WARNING
DISCONNECT ALL POWER BEFORE SERVICING.

Single Phase:

1. Disconnect the wire leads from the terminal (T) side of the contactor.
2. With power ON, energize the contactor.

 WARNING
LINE VOLTAGE NOW PRESENT.

3. Using a voltmeter, test across terminals.
 - a. L2 - T1 - No voltage indicates CC1 contacts open.

If a no voltage reading is obtained - replace the contactor.

SERVICING

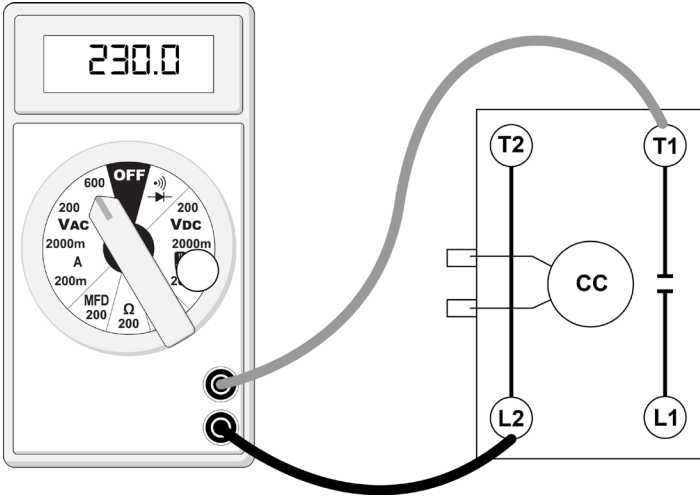

Testing Compressor Contactor
(Single Phase)

Three Phase

Using a voltmeter, test across terminals:

1. L1-L2, L1-L3, and L2-L3 - If voltage is present, proceed to B. If voltage is not present, check breaker or fuses on main power supply..
2. T1-T2, T1-T3, and T2-T3 - If voltage readings are not the same as in "A", replace contactor.

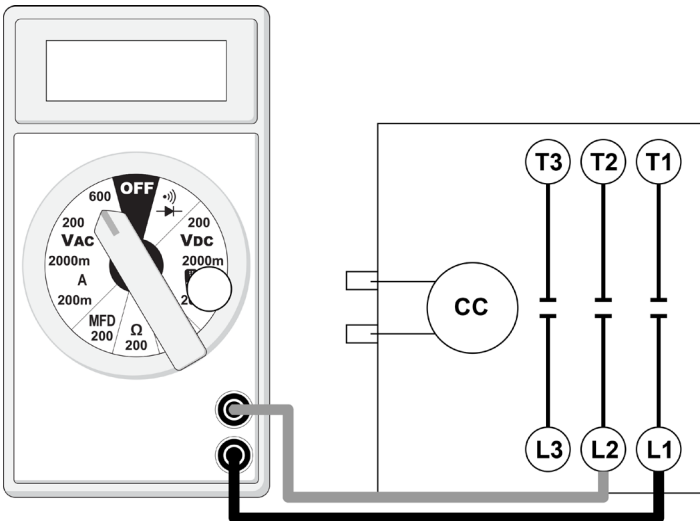

Testing Compressor Contactor
(Three-Phase)

Checking Fan Relay Contacts



WARNING

HIGH VOLTAGE!
DISCONNECT ALL POWER BEFORE SERVICING OR INSTALLING. MULTIPLE POWER SOURCES MAY BE PRESENT. FAILURE TO DO SO MAY CAUSE PROPERTY DAMAGE, PERSONAL INJURY OR DEATH.



1. Disconnect wire leads from terminals 2 and 4 of Fan Relay Cooling and 2 and 4, 5 and 6 of Fan Relay Heating.
2. Using an ohmmeter, test between 2 and 4 - should read open. Test between 5 and 6 - should read continuous.
3. With power ON, energize the relays.



WARNING

LINE VOLTAGE NOW PRESENT.

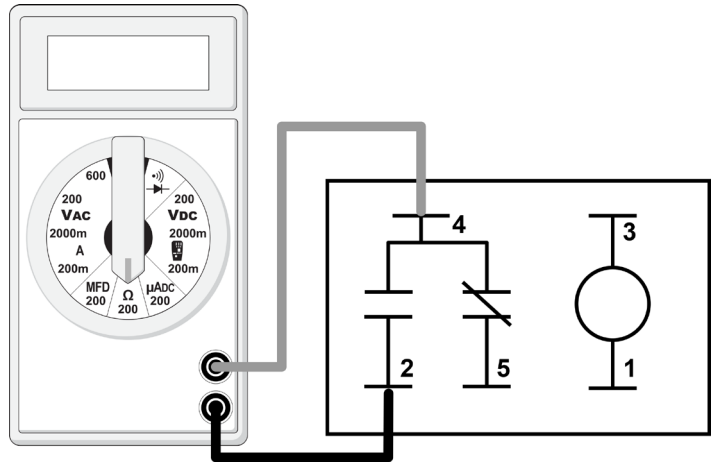

Testing Fan Relay

4. Using an ohmmeter, test between 2 and 4 - should read continuous. Test between 5 and 6 - should read open.
5. If not as above, replace the relay.

Checking Relay Contacts - PSC Fan Motor



WARNING

HIGH VOLTAGE!
DISCONNECT ALL POWER BEFORE SERVICING OR INSTALLING. MULTIPLE POWER SOURCES MAY BE PRESENT. FAILURE TO DO SO MAY CAUSE PROPERTY DAMAGE, PERSONAL INJURY OR DEATH.



1. Disconnect the motor leads from 6-circuit fan motor wire harness.
2. Connect a voltmeter between circuit 3 and circuits 2 (low speed) or 1 (high speed).

NOTE: Circuit 3 is connected directly to L2.

3. Energize the system at low or high stage.

SERVICING



WARNING

LINE VOLTAGE NOW PRESENT.

4. The measured voltage between circuit 3 and circuits 2 or 1 should be approximately 0VAC, which indicates the relay contacts are closed. A voltage measurement of approximately 115VAC indicates the relay is open. Replace the control if the relay checks open when it should be closed. See notes and cautions below.

NOTE: Ensure any ON delays have expired before making voltage measurements

CAUTION: Prolonged operation with the condenser fan motor disconnected will cause the high pressure switch to trip.

Checking Loss Of Charge Protector (Heat Pump Models)

The loss of charge protector senses the pressure in the liquid line and will open its contacts on a drop in pressure. The low pressure control will automatically reset itself with a rise in pressure.

The low pressure control is designed to cut-out (open) at approximately 21 PSIG. It will automatically cut-in (close) at approximately 50 PSIG. Test for continuity using a VOM and if not as above, replace the control.

Checking High Pressure Control



WARNING

HIGH VOLTAGE!
DISCONNECT ALL POWER BEFORE SERVICING OR INSTALLING. MULTIPLE POWER SOURCES MAY BE PRESENT. FAILURE TO DO SO MAY CAUSE PROPERTY DAMAGE, PERSONAL INJURY OR DEATH.



The high pressure control capillary senses the pressure in the compressor discharge line. If abnormally high condensing pressures develop, the contacts of the control open, breaking the control circuit before the compressor motor overloads. This control is automatically reset.

Test 1. Testing High Pressure Control in Cooling Mode

1. Connect refrigerant gages to unit.
2. Disconnect power to outdoor unit.
3. Remove control panel cover.
4. Disconnect black wire from condenser fan motor (single stage units) or remove plug from control board on 2 stage units. NOTE: Tape or isolate black wire to prevent possible short.

5. Apply power to unit and set thermostat to cool and set for all for cool.
6. High pressure switch should open at 610 PSIG +/- 10 PSIG and close at 420 PSIG +/- 25 PSIG.
7. If high pressure switch does not operate in these parameters replace switch.

Test 2. Testing High Pressure Control in Heating Mode

1. Connect refrigerant gages to unit.
2. Disconnect power to indoor unit.
3. Remove control panel cover.
4. Disconnect black wire from evaporator fan motor (single stage units) or remove plug from control board on 2 stage units. NOTE: Tape or isolate black wire to prevent possible short.
5. Apply power to unit and set thermostat to heat and set for call for heat.
6. High pressure switch should open at 610 PSIG +/- 10 PSIG and close at 420 PSIG +/- 25 PSIG.
7. If high pressure switch does not operate in these parameters replace switch.

With power ON:



WARNING

LINE VOLTAGE NOW PRESENT.

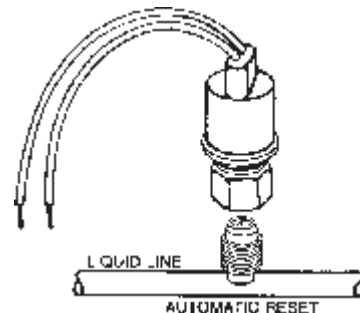

Checking Low Pressure Control

The low pressure control senses the pressure in the suction line and will open its contacts on a drop in pressure. The low pressure control will automatically reset itself with a rise in pressure.

Test 1. Testing Low Pressure Control in Cooling Mode

1. Connect refrigerant gages to unit.
2. Disconnect power to indoor unit.
3. Remove control panel cover.
4. Disconnect black wire from evaporator fan motor (single stage units) or remove plug from control board on 2 stage units. NOTE: Tape or isolate black wire to prevent possible short.

SERVICING

1. Apply power to unit and set thermostat to cool and set for a call for cool.
2. Low pressure switch should open at 21 PSIG, and auto reset (close) at approximately 50 PSIG.
3. If low pressure switch does not operate in these parameters replace switch.

Test 2. Testing Low Pressure Control in Heating Mode

1. Connect refrigerant gages to unit.
2. Disconnect power to outdoor unit.
3. Remove control panel cover.
4. Disconnect black wire from condenser fan motor (single stage units) or remove plug from control board on 2 stage units. NOTE: Tape or isolate black wire to prevent possible short.
5. Apply power to unit and set thermostat to cool and set for all for cool.
6. Low pressure switch should open at 21 PSIG and auto reset (close) at approximately 50 PSIG.
7. If low pressure switch does not operate in these parameters replace switch.

Copeland Comfort Alert™ Diagnostics - 3-Wire module Applies to ASX /ASZ and DSX/DSZ units



WARNING

HIGH VOLTAGE!
DISCONNECT ALL POWER BEFORE SERVICING OR INSTALLING. MULTIPLE POWER SOURCES MAY BE PRESENT. FAILURE TO DO SO MAY CAUSE PROPERTY DAMAGE, PERSONAL INJURY OR DEATH.

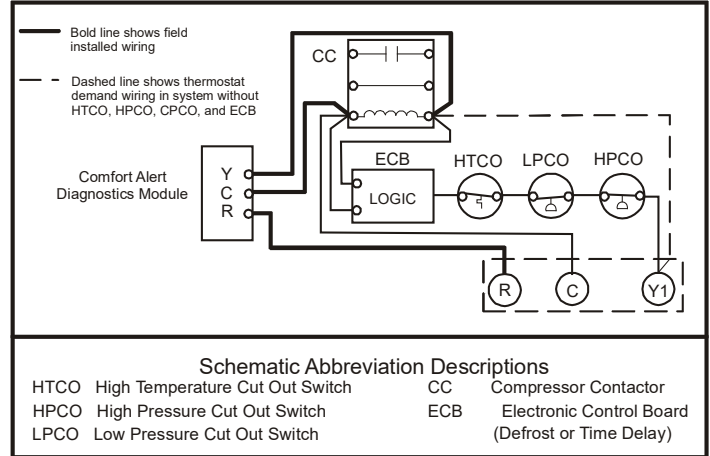

Comfort Alert™ is self-contained with no required external sensors and is designed to install directly into the electrical box of any residential condensing unit that has a Copeland Scroll™ compressor inside.

Once attached, Comfort Alert provides around-the-clock monitoring for common electrical problems, compressor defects and broad system faults. If a glitch is detected, an LED indicator flashes the proper alert codes to help you quickly pinpoint the problem. (See *Diagnostic Table: 3-Wire Comfort Alert Module on previous page.*)



Wiring Schematic - 3-Wire Comfort Alert Module



Copeland Coresense™ Diagnostics - 3-Wire module Applies to ASX /ASZ and DSX/DSZ units

WARNING

HIGH VOLTAGE!
DISCONNECT ALL POWER BEFORE SERVICING OR INSTALLING. MULTIPLE POWER SOURCES MAY BE PRESENT. FAILURE TO DO SO MAY CAUSE PROPERTY DAMAGE, PERSONAL INJURY OR DEATH.



The CoreSense™ module is self-contained with no required external sensors and works with any residential condensing unit that has a Copeland Scroll™ compressor inside.

SERVICING

Once attached, CoreSense™ provides around-the-clock monitoring for common electrical problems, compressor defects and broad system faults. If a glitch is detected, an LED indicator flashes the proper alert codes to help you quickly pinpoint the problem. See *Diagnostic Table: 3-Wire CoreSense™ Module on following pages.*

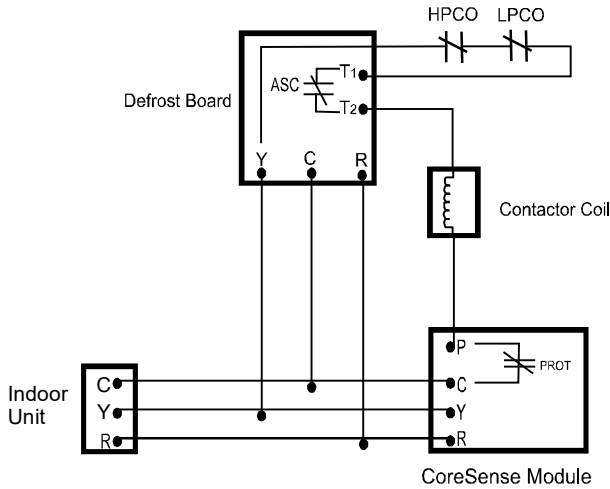

Schematic Abbreviation Descriptions

- | | | | |
|------|---------------------------------|-----|--|
| HTCO | High Temperature Cut Out Switch | CC | Compressor Contactor |
| HPCO | High Pressure Cut Out Switch | ECB | Electronic Control Board (Defrost or Time Delay) |
| LPCO | Low Pressure Cut Out Switch | | |

Wiring Schematic - 3-Wire Coresense™ Alert Module

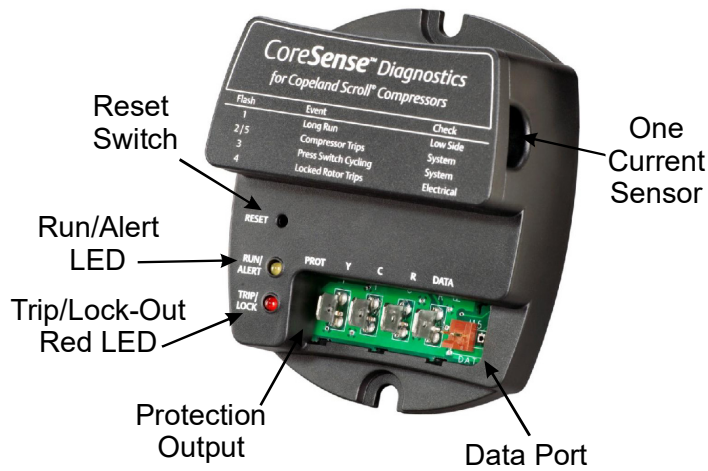

Diagnostics - 2-Wire Module Applies to ASX130[18-60]CA, ASX140[18-36]1CA, ASX140421DA, And ASX140[48-60]1BA Units

WARNING

HIGH VOLTAGE!
DISCONNECT ALL POWER BEFORE SERVICING OR INSTALLING. MULTIPLE POWER SOURCES MAY BE PRESENT. FAILURE TO DO SO MAY CAUSE PROPERTY DAMAGE, PERSONAL INJURY OR DEATH.

The CoreSense™ module is self-contained with no required external sensors and works with any residential condensing unit that has a Copeland Scroll™ compressor inside.

Once attached, CoreSense™ provides around-the-clock monitoring for common electrical problems, compressor defects and broad system faults. If a glitch is detected, an LED indicator flashes the proper alert codes to help you quickly pinpoint the problem. See *Diagnostic Table: 2-Wire Comfort Alert™ Module on following pages.*

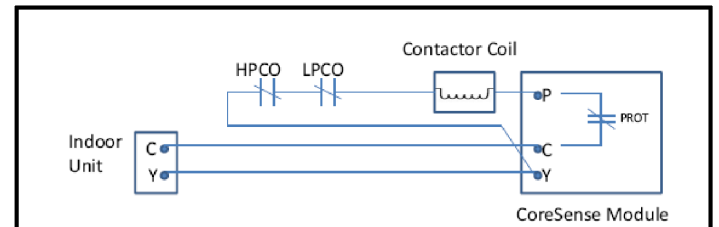

Schematic Abbreviation Descriptions

- | | | | |
|------|---------------------------------|-----|--|
| HTCO | High Temperature Cut Out Switch | CC | Compressor Contactor |
| HPCO | High Pressure Cut Out Switch | ECB | Electronic Control Board (Defrost or Time Delay) |
| LPCO | Low Pressure Cut Out Switch | | |

Wiring Schematic - 2-Wire Coresense™ Module

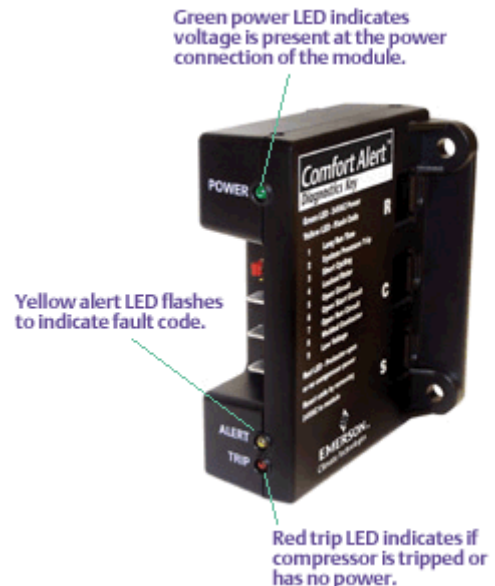

SERVICING

Diagnostics Table: 2-Wire Comfort Alert™ Module

Status LED	Status LED Description	Status LED Troubleshooting Information
Green “POWER”	Module has power	Supply voltage is present at module terminals
Red “TRIP”	Thermostat demand signal Y1 is present, but the compressor is not running	<ol style="list-style-type: none"> 1. Compressor protector is open 2. Outdoor unit power disconnect is open 3. Compressor circuit breaker or fuse(s) is open 4. Broken wire or connector is not making contact 5. Low pressure switch open if present in system 6. Compressor contactor has failed open
Yellow “ALERT” Flash Code 1	Long Run Time Compressor is running extremely long run cycles	<ol style="list-style-type: none"> 1. Low refrigerant charge 2. Evaporator blower is not running 3. Evaporator coil is frozen 4. Faulty metering device 5. Condenser coil is dirty 6. Liquid line restriction (filter drier blocked if present in system) 7. Thermostat is malfunctioning
Yellow “ALERT” Flash Code 2	System Pressure Trip Discharge or suction pressure out of limits or compressor overloaded	<ol style="list-style-type: none"> 1. High head pressure 2. Condenser coil poor air circulation (dirty, blocked, damaged) 3. Condenser fan is not running 4. Return air duct has substantial leakage 5. If low pressure switch present in system, check Flash Code 1 information
Yellow “ALERT” Flash Code 3	Short Cycling Compressor is running only briefly	<ol style="list-style-type: none"> 1. Thermostat demand signal is intermittent 2. Time delay relay or control board defective 3. If high pressure switch present go to Flash Code 2 information 4. If low pressure switch present go to Flash Code 1 information
Yellow “ALERT” Flash Code 4	Locked Rotor	<ol style="list-style-type: none"> 1. Run capacitor has failed 2. Low line voltage (contact utility if voltage at disconnect is low) 3. Excessive liquid refrigerant in compressor 4. Compressor bearings are seized
Yellow “ALERT” Flash Code 5	Open Circuit	<ol style="list-style-type: none"> 1. Outdoor unit power disconnect is open 2. Compressor circuit breaker or fuse(s) is open 3. Compressor contactor has failed open 4. High pressure switch is open and requires manual reset 5. Open circuit in compressor supply wiring or connections 6. Unusually long compressor protector reset time due to extreme ambient temperature 7. Compressor windings are damaged
Yellow “ALERT” Flash Code 6	Open Start Circuit Current only in run circuit	<ol style="list-style-type: none"> 1. Run capacitor has failed 2. Open circuit in compressor start wiring or connections 3. Compressor start winding is damaged
Yellow “ALERT” Flash Code 7	Open Run Circuit Current only in start circuit	<ol style="list-style-type: none"> 1. Open circuit in compressor run wiring or connections 2. Compressor run winding is damaged
Yellow “ALERT” Flash Code 9	Low Voltage Control circuit < 17VAC	<ol style="list-style-type: none"> 1. Control circuit transformer is overloaded 2. Low line voltage (contact utility if voltage at disconnect is low)

- FLASH CODE NUMBER CORRESPONDS TO A NUMBER OF LED FLASHES, FOLLOWED BY A PAUSE AND THEN REPEATED
- TRIP AND ALERT LEDS FLASHING AT SAME TIME MEANS CONTROL CIRCUIT VOLTAGE IS TOO LOW FOR OPERATION.
- LAST ALERT FLASH CODE IS DISPLAYED FOR 1 MINUTE AFTER MODULE IS POWERED ON.

SERVICING

Diagnostics Table: Coresense™ Module

Flash code number corresponds to the number of LED flashes, followed by a pause and then repeated. TRIP and ALERT LEDs flashing at the same time mean control circuit voltage is too low for operation.

Status	Description	Troubleshooting Information
Solid Yellow "RUN"	Module has power and operating normally	Supply voltage is present at module terminals
Solid Red "TRIP"	Thermostat demand signal Y is present, but the compressor is not running	<ol style="list-style-type: none"> 1. Compressor protector is open <ul style="list-style-type: none"> • Check for high head pressure • Check compressor supply voltage 2. Outdoor unit power disconnect is open 3. Compressor circuit breaker or fuse(s) is open 4. Broken wire or connector is not making contact 5. High pressure switch open if present in system 6. Compressor contactor has failed open
"ALERT" Flash Codes		
Yellow "ALERT" Flash Code 1	Long Run Time; Compressor is running extremely long run cycles indicative of low capacity due to a system low-side fault	<ol style="list-style-type: none"> 1. Low refrigerant charge 2. Evaporator blower is not running <ul style="list-style-type: none"> • Check blower relay coil and contacts • Check blower motor capacitor • Check blower motor for failure or blockage • Check evaporator blower wiring and connectors • Check indoor blower control board • Check thermostat wiring for open circuit 3. Evaporator coil is frozen <ul style="list-style-type: none"> • Check for low suction pressure • Check for excessively low thermostat setting • Check evaporator airflow (coil blockages or return air filter) • Check ductwork or registers for blockage 4. Faulty metering device <ul style="list-style-type: none"> • Check TXV bulb installation (size, location and contact) • Check if TXV/fixed orifice is stuck closed or defective 5. Liquid line restriction (filter drier blocked if present in system) 6. Thermostat is malfunctioning <ul style="list-style-type: none"> • Check thermostat sub-base or wiring for short circuit • Check thermostat installation (location, level)
Yellow "ALERT" Flash Code 2	Compressor (Pressure) Trip; Discharge pressure out of limits or compressor overloaded	<ol style="list-style-type: none"> 1. Condenser fan is not running <ul style="list-style-type: none"> • Check fan capacitor • Check fan wiring and connectors • Check fan motor for failure or blockage 2. High head pressure <ul style="list-style-type: none"> • Check high pressure switch if present in system • Check if system is overcharged with refrigerant • Check for non-condensable in system 3. Condenser coil poor air circulation (dirty, blocked, damaged)
Yellow "ALERT" Flash Code 3	Short Cycling; Compressor is running only briefly	<ol style="list-style-type: none"> 1. Thermostat demand signal is intermittent 2. Time delay relay or control board defective 3. Low or high pressure switch is cycling

SERVICING

Diagnostics Table: Coresense™ Module

Flash code number corresponds to the number of LED flashes, followed by a pause and then repeated. TRIP and ALERT LEDs flashing at the same time mean control circuit voltage is too low for operation.

Status	Description	Troubleshooting Information
Yellow "ALERT" Flash Code 4	Locked Rotor	<ol style="list-style-type: none"> Run capacitor has failed Low line voltage (contact utility if voltage at disconnect is low) <ul style="list-style-type: none"> Check wiring connections Excessive liquid refrigerant in compressor Compressor bearings are seized <ul style="list-style-type: none"> Measure compressor oil level
Yellow "ALERT" Flash Code 5	Compressor (Moderate Run) Trip	<ol style="list-style-type: none"> Evaporator blower is not running <ul style="list-style-type: none"> Check blower relay coil and contacts Check blower motor capacitor Check blower motor for failure or blockage Check evaporator blower wiring and connectors Check indoor blower control board Check thermostat wiring for open circuit Faulty metering device <ul style="list-style-type: none"> Check TXV bulb installation (size, location and contact) Check if TXV/fixed orifice is stuck closed or defective Condenser coil poor air circulation (dirty, blocked, damaged) Low refrigerant charge
"LOCK" Flash Codes		
Red "LOCK" Flash Code 2 Yellow Off	Compressor (Pressure) Trip; Compressor is locked out after 4 consecutive or 10 total compressor (pressure) trip events	<ol style="list-style-type: none"> Condenser fan is not running <ul style="list-style-type: none"> Check fan capacitor Check fan wiring and connectors Check fan motor for failure or blockage High head pressure <ul style="list-style-type: none"> Check high pressure switch if present in system Check if system is overcharged with refrigerant Check for non-condensable in system Condenser coil poor air circulation (dirty, blocked, damaged)
Red "LOCK" Flash Code 3 Yellow Off	Short Cycling; Compressor is locked out after 10 consecutive short cycling events	<ol style="list-style-type: none"> Thermostat demand signal is intermittent Time delay relay or control board defective If high pressure switch present go to Flash Code 2 information
Red "LOCK" Flash Code 4 Yellow Off	Locked Rotor; Compressor is locked out after 10 consecutive locked rotor events	<ol style="list-style-type: none"> Run capacitor has failed Low line voltage (contact utility if voltage at disconnect is low) <ul style="list-style-type: none"> Check wiring connections Excessive liquid refrigerant in compressor Compressor bearings are seized <ul style="list-style-type: none"> Measure compressor oil level
Red "LOCK" Flash Code 5 Yellow Off	Compressor (Moderate Run) Trip; Compressor is locked out after 4 consecutive or 10 total compressor (moderate run) trip events	<ol style="list-style-type: none"> Evaporator blower is not running <ul style="list-style-type: none"> Check blower relay coil and contacts Check blower motor capacitor Check blower motor for failure or blockage Check evaporator blower wiring and connectors Check indoor blower control board Check thermostat wiring for open circuit Faulty metering device <ul style="list-style-type: none"> Check TXV bulb installation (size, location and contact) Check if TXV/fixed orifice is stuck closed or defective Condenser coil poor air circulation (dirty, blocked, damaged) Low refrigerant charge

SERVICING

Table 1 - Quick Reference Table

Alert Code	Alert Condition	Lock Level	Lock Indication
Normal Run Solid Yellow	Normal operation, no trip	N/A	N/A
Code1 Yellow Flash 1	Long run time. Compressor is on running for more than 18 hours. (Code1 is disabled in Heat Pump mode.)	N/A	N/A
Code2 Yellow Flash 2	Compressor (pressure) trip. Compressor runs for 12 sec to 15 min followed by a compressor trip condition lasting longer than 7 min.	4x consecutive	Red: Flash 2 Yellow: Off
Code3 Yellow Flash 3	Pressure switch cycling. Compressor runs for 12 sec to 15 min followed by a compressor trip lasting between 35 sec to 7 min.	4x consecutive or 10x total	Red: Flash 3 Yellow: Off
Code4 Yellow Flash 4	Locked rotor. Compressor trips within a compressor run time of 12 sec and does not start within 35 sec.	10x consecutive	Red: Flash 4 Yellow: Off
Code5 Yellow Flash 5	Compressor (moderate run) trip. Compressor runs for 15 min to 18 hrs followed by a compressor trip lasting longer than 7 min.	4x consecutive or 10x total	Red: Flash 5 Yellow: Off
Code9 Red Flash 9	The current to the PROT terminal is greater than 2A	Current > 2A for 40ms	Red: Flash 9 Yellow: Off
Trip Solid Red	Demand is present, but compressor is not running	N/A	N/A

SERVICING



Checking Capacitor

Capacitor, Run

A run capacitor is wired across the auxiliary and main windings of a single phase permanent split capacitor motor. The capacitor's primary function is to reduce the line current while greatly improving the torque characteristics of a motor. This is accomplished by using the 90° phase relationship between the capacitor current and voltage in conjunction with the motor windings, so that the motor will give two phase operation when connected to a single phase circuit. The capacitor also reduces the line current to the motor by improving the power factor.

The line side of this capacitor is marked with "COM" and is wired to the line side of the circuit.

Resistance Check Using A Digital Multi-Meter

 WARNING
HIGH VOLTAGE! DISCONNECT ALL POWER BEFORE SERVICING OR INSTALLING. MULTIPLE POWER SOURCES MAY BE PRESENT. FAILURE TO DO SO MAY CAUSE PROPERTY DAMAGE, PERSONAL INJURY OR DEATH.

Check for Digital Test

1. Set the meter on Ohm range (Set it at least 1000 Ohm=1k).

 WARNING
DISCHARGE CAPACITOR THROUGH A 200 TO 300 OHM RESISTOR BEFORE HANDLING.

2. Connect the Meter leads to the Capacitor terminals.
3. Digital meter will show a reading momentarily (Figure 1). Note the reading.



Figure 1



Figure 2

4. Reading will immediately return to the OL = (Open Line) (Figure 2). Every attempt of Step 2 will show the same result as was in step 4 and Step 5. This indicates that the capacitor is good.
5. If there is no Change, then capacitor is dead and must be replaced.

Check for Analog Meter

1. Good Condition - indicator swings to zero and slowly returns to infinity (Start capacitor with bleed resistor will not return to infinity. It will still read the resistance of the resistor).
2. Shorted - indicator swings to zero and stops there - replace.
3. Open - no reading - replace (Start capacitor would read resistor resistance).

Capacitance Check Using A Digital Multi-Meter (In Capacitance Mode)

 WARNING
DISCHARGE CAPACITOR THROUGH A 200 TO 300 OHM RESISTOR BEFORE HANDLING.

NOTE: You can do this test with a multi-meter if you have a Capacitance meter on your multi-meter.

1. Remove the capacitor from the circuit.
2. Now Select "Capacitance" on your multi-meter.
3. Now connect the capacitor terminals to the multi-meter leads.
4. If the reading is near to the actual value of the capacitor (i.e. the printed value on the capacitor). The capacitor is good (Note that the reading may be less than the actual printed value of the capacitor).
5. If you read a significantly lower capacitance or none at all, then capacitor is dead and must be replaced.

Capacitor, Start Scroll Compressor Models

In most cases hard start components are not required on Scroll compressor equipped units due to a non-replaceable check valve located in the discharge line of the compressor. However, in installations that encounter low lock rotor voltage, a hard start kit can improve starting characteristics and reduce light dimming within the home. Only hard start kits approved by Amana® brand or Copeland should be used. "Kick Start" and/or "Super Boost" kits are not approved start assist devices.

The discharge check valve closes off high side pressure to the compressor after shut down allowing equalization through the scroll flanks. Equalization requires only about ½ second.

SERVICING

To prevent the compressor from short cycling, a Time Delay Relay (Cycle Protector) has been added to the low voltage circuit.



Testing a Run Capacitor Under Load

1. Measure the amperage of the wire from Herm on the capacitor to start terminal on compressor.
2. Multiply the amperage reading by the constant of 2,652
3. Measure voltage across the capacitor between "HERM" and "C" terminals this is the measured voltage across the start and run terminals on the compressor.
4. Divide total from step 2 by the voltage measurement. This total is the capacitance. This give a more accurate measurement of the capacitor's performance.
5. Read the rated MFD on the capacitor and compare to your actual readings. If outside of +/- tolerance stated on the capacitor, replacement of the capacitor may be recommended.

Formula: Start Winding Amps x 2,652 ÷ capacitor voltage = microfarads.

Checking Outdoor Fan and Blower Motors (PSC Motors)

The auto reset fan motor overload is designed to protect the motor against high temperature and high amperage conditions by breaking the common circuit within the motor, similar to the compressor internal overload. However, heat generated within the motor is faster to dissipate than the compressor, allow at least 45 minutes for the overload to reset, then retest.

 WARNING	
HIGH VOLTAGE! DISCONNECT ALL POWER BEFORE SERVICING OR INSTALLING. MULTIPLE POWER SOURCES MAY BE PRESENT. FAILURE TO DO SO MAY CAUSE PROPERTY DAMAGE, PERSONAL INJURY OR DEATH.	

1. Remove the motor leads from its respective connection points and capacitor (if applicable).
2. Check the continuity between each of the motor leads.
3. Touch one probe of the ohmmeter to the motor frame (ground) and the other probe in turn to each lead.

If the windings do not test continuous or a reading is obtained from lead to ground, replace the motor.

Checking Fan and Blower Motor (ECM Motors)

An ECM is an *Electronically Commutated Motor* which offers many significant advantages over PSC motors. The ECM has near zero rotor loss, synchronous machine operation, variable speed, low noise, and programmable air flow. Because of the sophisticated electronics within the ECM motor, some technicians are intimidated by the ECM motor; however, these fears are unfounded. GE/Regal Beloit offers two ECM motor testers, and with a VOM meter, one can easily perform basic troubleshooting on ECM motors. An ECM motor requires power (line voltage) and a signal (24 volts) to operate. The ECM motor stator contains permanent magnet. As a result, the shaft feels "rough" when turned by hand. This is a characteristic of the motor, not an indication of defective bearings.

 WARNING
LINE VOLTAGE NOW PRESENT.

1. Disconnect the 5-pin connector from the motor.
2. Using a volt meter, check for line voltage at terminals #4 & #5 at the power connector. If no voltage is present:
3. Check the unit for incoming power.
4. Check the control board.
5. If line voltage is present, reinsert the 5-pin connector and remove the 16-pin connector.
6. Check for signal (24 volts) at the transformer.
7. Check for signal (24 volts) from the thermostat to the "G" terminal at the 16-pin connector.
8. Using an ohmmeter, check for continuity from the #1 & #3 (common pins) to the transformer neutral or "C" thermostat terminal. If you do not have continuity, the motor may function erratically. Trace the common circuits, locate and repair the open neutral.
9. Set the thermostat to "Fan-On". Using a voltmeter, check for 24 volts between pin # 15 (G) and common.
10. Disconnect power to compressor. Set thermostat to call for cooling. Using a voltmeter, check for 24 volts at pin #6 and or #14.
11. Set the thermostat to a call for heating. Using a voltmeter, check for 24 volts at pin #2 and/or #11.

SERVICING

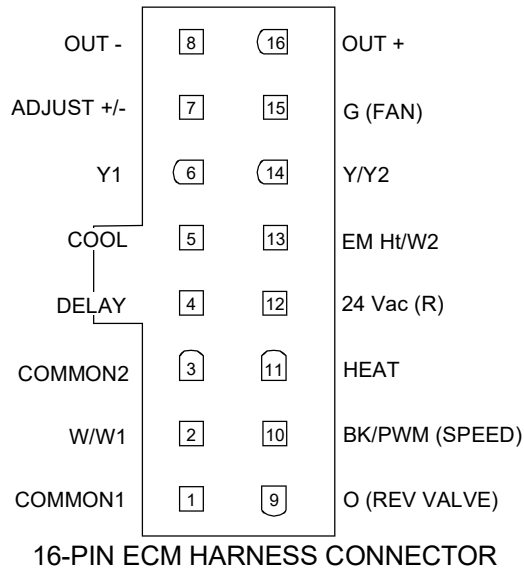
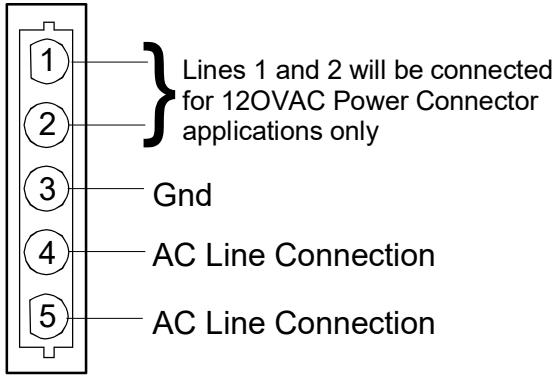

If you do not read voltage and continuity as described, the problem is in the control or interface board, but not the motor. If you register voltage as described, the ECM power head is defective and must be replaced.

Checking ECM Motor Windings

WARNING

HIGH VOLTAGE!
DISCONNECT ALL POWER BEFORE SERVICING OR INSTALLING. MULTIPLE POWER SOURCES MAY BE PRESENT. FAILURE TO DO SO MAY CAUSE PROPERTY DAMAGE, PERSONAL INJURY OR DEATH.

1. Disconnect the 5-pin and the 16-pin connectors from the ECM power head.
2. Remove the 2 screws securing the ECM power head and separate it from the motor.
3. Disconnect the 3-pin motor connector from the power head and lay it aside.

4. Using an ohmmeter, check the motor windings for continuity to ground (pins to motor shell). If the ohmmeter indicates continuity to ground, the motor is defective and must be replaced.
5. Using an ohmmeter, check the windings for continuity (pin to pin). If no continuity is indicated, the thermal limit (over load) device may be open. Allow motor to cool and retest.

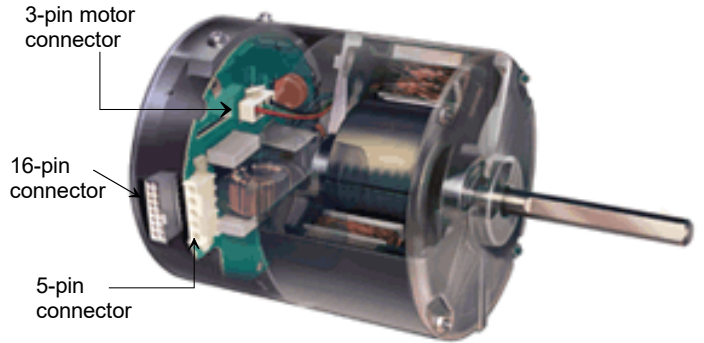

ECM CFM Adjustments MBE/AEPF

MBE Motor

This section references the operation characteristics of the MBE/AEPF models motor only. The ECM control board is factory set with the dipswitch #4 in the "ON" position and all other dipswitches are factory set in the "OFF" position. When MBE/AEPF are used with 2-stage cooling units, dipswitch #4 should be in the "OFF" position.

For most applications, the settings are to be changed according to the electric heat size and the outdoor unit selection.

The MBE/AEPF products use a GE/Regal Beloit ECMTM motor. This motor provides many features not available on the traditional PSC motor. These features include:

- Improved Efficiency
- Constant CFM
- Soft Start and Stop
- Improved Humidity Control

Motor Speed Adjustment

Each ECM™ blower motor has been preprogrammed for operation at 4 distinct airflow levels when operating in Cooling/Heat Pump mode or Electric Heat mode. These 4 distinct levels may also be adjusted slightly lower or higher if desired. The adjustment between levels and the trim adjustments are made by changing the dipswitch(s) either to an "OFF" or "ON" position.

SERVICING

Dipswitch Functions

The MBE / AEPF air handler motors have an electronic control that contains an eight (8) position dip switch. The function of these dipswitches are shown in **Table 1**.

Dipswitch Functions

Dipswitch Number	Function
1	Electric Heat
2	
3	N/A
4	Indoor Thermostat
5	Cooling & Heat Pump CFM
6	
7	CFM Trim Adjust
8	

Table 1

CFM Delivery

Tables 2, 3, 5 and 6 show the CFM output for dipswitch combinations 1-2, and 5-6.

Electric Heat Operation

Model	Switch 1	Switch 2	CFM
MBE1200	OFF	OFF	1,200
	ON	OFF	1,000
	OFF	ON	800
	ON	ON	600
MBE1600	OFF	OFF	1,600
	ON	OFF	1,400
	OFF	ON	1,200
	ON	ON	1,000
MBE2000	OFF	OFF	2,000
	ON	OFF	1,800
	OFF	ON	1,600
	ON	ON	1,200

Table 2

Cooling/Heat Pump Operation

Model	Switch 5	Switch 6	CFM
MBE1200	OFF	OFF	1,200
	ON	OFF	1,000
	OFF	ON	800
	ON	ON	600
MBE1600	OFF	OFF	1,600
	ON	OFF	1,400
	OFF	ON	1,200
	ON	ON	1,000
MBE2000	OFF	OFF	2,000
	ON	OFF	1,800
	OFF	ON	1,600
	ON	ON	1,200

Table 3

Thermostat “Fan Only” Mode

During Fan Only Operations, the CFM output is 30% of the cooling setting.

Dipswitch Functions

The AEPF air handler motor has an electronic control that contains an eight (8) position dip switch. The function of these dipswitches are shown in **Table 9**.

Dipswitch Number	Function
1	Electric Heat
2	
3	N/A
4	Indoor Thermostat
5	Cooling & Heat Pump CFM
6	
7	CFM Trim Adjust
8	

Table 9

SERVICING

CFM Delivery

Tables 10-Electric Heat and 11-Cooling/Heat Pump show the CFM output for dipswitch combinations 1-2, and 5-6.

Model	Switch		Switch		Emergency (Electric) Heat	Heat Pump w/Backup Heat
	1	2	7	8		
AEPF1830	OFF	OFF	OFF	OFF	1100	1210
	ON	OFF	OFF	OFF	890	935
	OFF	ON	OFF	OFF	700	770
AEPF3036	OFF	OFF	OFF	OFF	2050	2150
	ON	OFF	OFF	OFF	1750	1835
AEPF3137	OFF	ON	OFF	OFF	1600	1680
AEPF4260	ON	ON	OFF	OFF	1200	1260
	ON	ON	OFF	ON	1020	1070

Table 10

Model	Switch		Switch		Nominal Cooling Tonnage	CFM
	5	6	7	8		
AEPF1830	OFF	OFF	OFF	OFF	2 ½	1100
	ON	OFF	OFF	OFF	2	800
	OFF	ON	OFF	OFF	1 ½	600
AEPF3036	OFF	OFF	OFF	OFF	5	1800
	ON	OFF	OFF	OFF	4	1580
AEPF3137	OFF	ON	OFF	OFF	3 ½	1480
AEPF4260	ON	ON	OFF	OFF	3	1200
	ON	ON	OFF	ON	2 ½	1020

Table 11

Thermostat “Fan Only Mode”

During “Fan Only Mode” operation, the CFM output is 30% of the cooling setting.

CFM Trim Adjust

Minor adjustments can be made through the dip switch combination of 7-8. The following Table 12 shows the switch position for this feature.

CFM	Switch 7	Switch 8
+10%	ON	OFF
-15%	OFF	ON

Humidity Control

When using a Humidistat (normally closed), cut jumper PJ6 on the control board. The Humidistat will only affect cooling airflow by adjusting the Airflow to 85%.

SERVICING

Troubleshooting Chart for GE/Regal-Beloit ECM Variable Speed Air Circulator Blower Motors			
Symptom	Fault Description(s)	Possible Causes	Corrective Action
- Motor rocks slightly when starting.	- This is normal start-up for variable speed motor.	----	----
- Motor won't start.	- No movement.	<ul style="list-style-type: none"> - Manual disconnect switch off or door switch open. - Blown fuse or circuit breaker. - 24 Vac wires miswired. - Unseated pins in wiring harness connectors. - Bad motor/control module. - Moisture present in motor or control module. 	<ul style="list-style-type: none"> - Check 230 Vac power at motor. - Check low voltage (24 Vac R to C) at motor. - Check low voltage connections (G, Y, W, R, C) at motor. - Check for unseated pins in connectors on motor harness. - Test with a temporary jumper between R - G.
	- Motor rocks, but won't start.	<ul style="list-style-type: none"> - Loose motor mount. - Blower wheel not tight on motor shaft. - Bad motor/control module. 	<ul style="list-style-type: none"> - Check for loose motor mount. - Make sure blower wheel is tight on shaft. - Perform motor/control replacement check, ECM motors only.
- Motor oscillates up & down while being tested off of blower.	- It is normal for motor to oscillate with no load on shaft.	----	----
- Motor starts, but runs erratically.	- Varies up and down or intermittent.	<ul style="list-style-type: none"> - Variation in 230 Vac to motor. - Unseated pins in wiring harness connectors. - Erratic CFM command from "BK" terminal. - Improper thermostat connection or setting. - Moisture present in motor/control module. 	<ul style="list-style-type: none"> - Check line voltage for variation or "sag". - Check low voltage connections (G, Y, W, R, C) at motor, unseated pins in motor harness connectors. - Check-out system controls - Thermostat. - Perform Moisture Check.*
	- "Hunts" or "puffs" at high CFM (speed).	<ul style="list-style-type: none"> - Incorrect or dirty filter(s). - Incorrect supply or return ductwork. - Incorrect blower speed setting. 	<ul style="list-style-type: none"> - Does removing panel or filter reduce "puffing"? - Check/replace filter. - Check/correct duct restrictions. - Adjust to correct blower speed setting.

***Moisture Check**

- Connectors are oriented "down" (or as recommended by equipment manufacturer).
- Is condensate drain plugged?
- Check for unenergized condenser.

Note: You must use the correct replacement control/motor module since they are factory programmed for specific operating modes. Even though they look alike, different modules may have completely different functionality. The ECM variable speed motors are C

Important Note: Using the wrong motor/control module voids all product warranties and may produce unexpected results.

CHART CONTINUED ON NEXT PAGE

CHART CONTINUED FROM PREVIOUS PAGE.

Troubleshooting Chart for GE/Regal-Beloit ECM Variable Speed Air Circulator Blower Motors

Symptom	Fault Description(s)	Possible Causes	Corrective Action	Cautions and Notes
- Motor starts, but runs erratically.	- Stays at low CFM despite system call for cool or heat CFM.	- 24 Vac wires miswired or loose. - "R" missing/not connected at motor. - Fan in delay mode.	- Check low voltage (Thermostat) wires and connections. - Verify fan is not in delay mode - wait until delay complete. - Perform motor/control replacement check, ECM motors only.	- Turn power OFF prior to repair. Wait 5 minutes after disconnecting power before opening motor. - Handle electronic motor/control with care.
	- Stays at high CFM.	- "R" missing/not connected at motor. - Fan in delay mode.	- Is fan in delay mode? - wait until delay time complete. - Perform motor/control replacement check, ECM motors only.	- Turn power OFF prior to repair. Wait 5 minutes after disconnecting power before opening motor. - Handle electronic motor/control with care.
	- Blower won't shut off.	- Current leakage from controls into G, Y, or W.	- Check for Triac switched stat or solid state relay.	- Turn power OFF prior to repair.
- Excessive noise.	- Air noise.	- High static creating high blower speed. - Incorrect supply or return ductwork. - Incorrect or dirty filter(s). - Incorrect blower speed setting.	- Check/replace filter. - Check/correct duct restrictions. - Adjust to correct blower speed setting.	- Turn power OFF prior to repair.
	- Noisy blower or cabinet.	- Loose blower housing, panels, etc. - High static creating high blower speed. - Air leaks in ductwork, cabinets, or panels.	- Check for loose blower housing, panels, etc. - Check for air whistling thru seams in ducts, cabinets or panels. - Check for cabinet/duct deformation.	- Turn power OFF prior to repair.
	- "Hunts" or "puffs" at high CFM (speed).	- High static creating high blower speed. - Incorrect or dirty filter(s). - Incorrect supply or return ductwork. - Incorrect blower speed setting.	- Does removing panel or filter reduce "puffing"? - Check/replace filter. - Check/correct duct restrictions. - Adjust to correct blower speed setting.	- Turn power OFF prior to repair.
- Evidence of Moisture.	- Moisture in motor/control module.	- Moisture in motor/control module.	- Replace motor and perform Moisture Check.*	- Turn power OFF prior to repair. Wait 5 minutes after disconnecting power before opening motor. - Handle electronic motor/control with care.

***Moisture Check**

- Connectors are oriented "down" (or as recommended by equipment manufacturer).
- Is condensate drain plugged?
- Check for unenergized condition.

Note: You must use the correct replacement control/motor module since they are factory programmed for specific operating modes. Even though they look alike, different modules may have completely different functionality. The ECM variable speed motors are c

Important Note: Using the wrong motor/control module voids all product warranties and may produce unexpected results.

SERVICING

Blower Performance Data

SPEED	STATIC	MBR800**-* SCFM	MBR1200**-* SCFM	MBR1600**-* SCFM	MBR2000**-* SCFM
HIGH	0.1	1,240	1,500	1,800	2,160
	0.2	1,170	1,460	1,740	2,080
	0.3	1,120	1,360	1,680	1,990
	0.4	1,060	1,280	1,610	1,890
	0.5	980	1,200	1,520	1,790
	0.6	900	1,110	1,430	1,690
MEDIUM	0.1	900	1,380	1,540	1,730
	0.2	850	1,320	1,490	1,670
	0.3	790	1,270	1,450	1,590
	0.4	740	1,200	1,400	1,520
	0.5	680	1,140	13,560	1,420
	0.6	605	1,040	1,280	1,320
LOW	0.1	650	1,170	1,130	1,520
	0.2	590	1,130	1,100	1,450
	0.3	540	1,080	1,070	1,360
	0.4	500	1,020	1,030	1,290
	0.5	430	950	990	1,200
	0.6	330	830	930	1,090

NOTE: External static is for blower @ 230 Volts. It does not include Coil, Air Filter or Electric Heaters.

Checking High Efficiency Motors

The motor is a one piece, fully encapsulated, 3 phase brushless DC (single phase AC input) motor with ball bearing construction.

1. Using a voltmeter, check for 230 volts to the motor connections L and N. If 230 volts is present, proceed to step 2. If 230 volts is not present, check the line voltage circuit to the motor.
2. Using a voltmeter, check for 24 volts from terminal C to either terminal 1, 2, 3, 4, or 5, depending on which tap is being used, at the motor. If voltage present, proceed to step 3. If no voltage, check 24 volt circuit to motor.
3. If voltage was present in steps 1 and 2, the motor has failed and will need to be replaced.

NOTE: When replacing motor, ensure the belly band is between the vents on the motor and the wiring has the proper drip loop to prevent condensate from entering the motor.

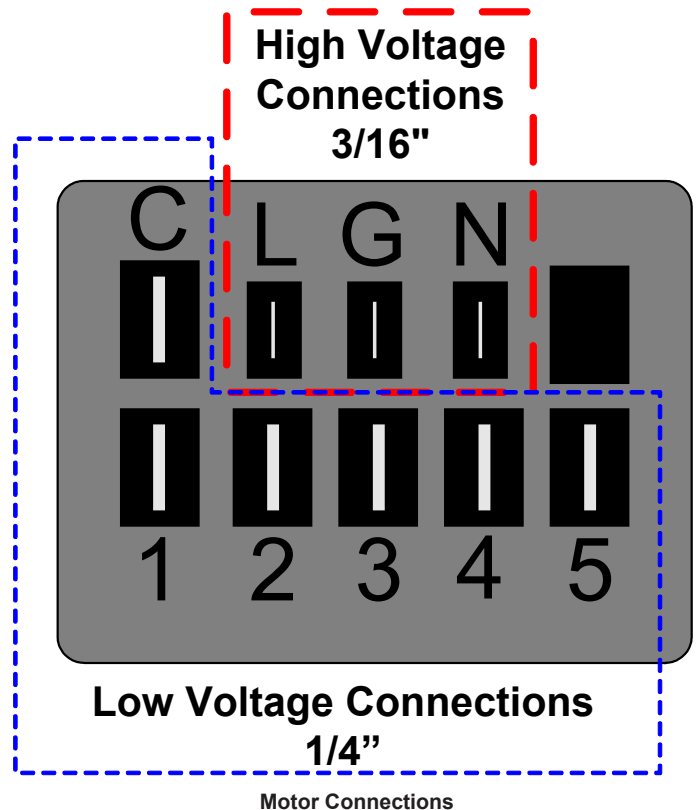

SERVICING

EEM Blower Replacement

For AWUF19-25, AWUF31-32, and AWUF37 Air Handlers.

1. Disconnect power at main electrical panel.
2. Remove front access panel.
3. Remove the two screws on each side holding the lower control box and move out of the way to give access to the blower assembly

Remove lower control box

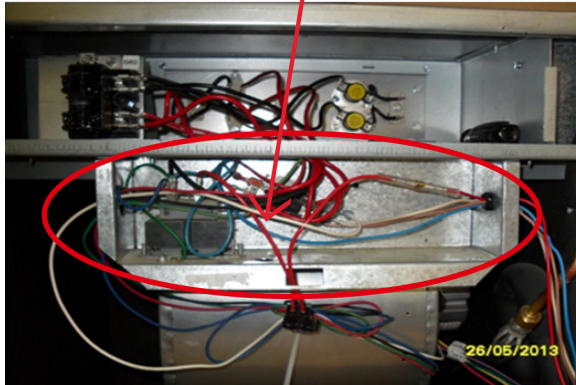

Remove screws on both side of control box

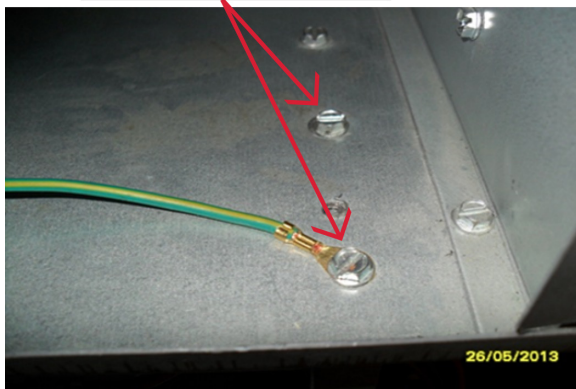

4. Loosen or remove set screw on blower wheel hub and ensure the wheel slides freely on the shaft of the motor.



5. Install cardboard or rug over coil to protect fins from damage.

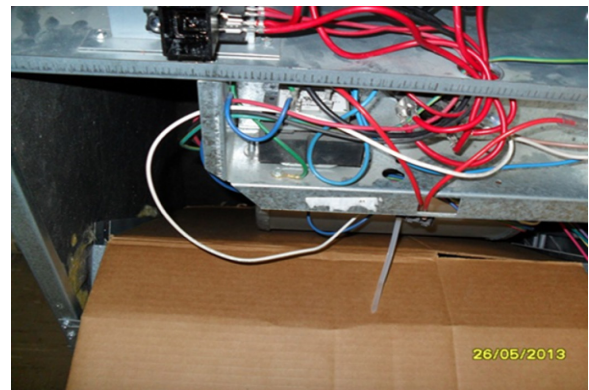

6. Remove the three 3/8" screws holding the blower in place.

Remove screws and drop blower Assembly and allow to rest on coil

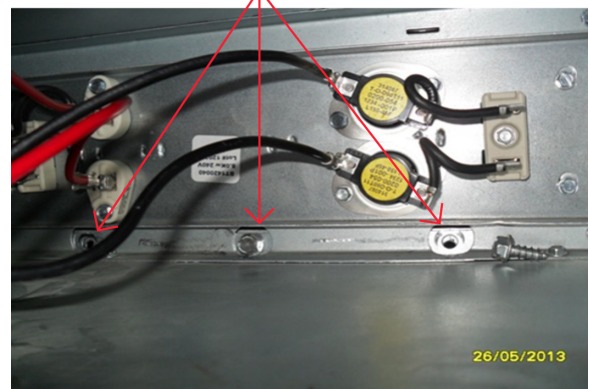

7. Lower blower onto coil.
8. Slide blower assembly all the way to the left side of cabinet.

SERVICING

Slide blower to the left

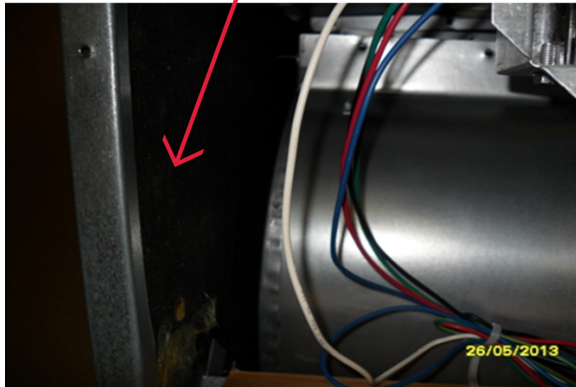

9. Remove the bolts holding the motor bracket to the blower and slide out of blower shell.

Remove screws holding Motor bracket



10. Replace the motor and reinstall blower and control box.
11. Reconnect power and test operation.

MBR/AR*F Electronic Blower Time Delay Relay

The MBR/AR*F contains an Electronic Blower Time Delay Relay board, B1370735. This board provides on/off time delays for the blower motor in cooling and heat pump heating demands when “G” is energized.

During a cooling or heat pump heating demand, 24Vac is supplied to terminal “G” of the EBTD board to turn on the blower motor. The EBTD board initiates a 7 second delay on and then energizes it’s onboard relay. The relay on the EBTD board closes it’s normally open contacts and supplies power to the blower motor. When the “G” input is removed, the EBTD board initiates a 65 second delay off. When the 65 seconds delay expires the onboard relay is de-energized and it’s contacts open and remove power from the blower motor.

During an electric heat only demand, “W1” is energized but “G” is not. The blower motor is connected to the normally closed contacts of the relay on the EBTD board. The other side of this set of contacts is connected to the heat sequencer on the heater assembly that provides power to the first heater element. When “W1” is energized, the sequencer will close it’s contacts within 10 to 20 seconds to supply power to the first heater element and to the blower motor through the normally closed contacts on the relay on the EBTD. When the “W1” demand is removed, the sequencer opens it contacts within 30 to 70 seconds and removes power from the heater element and the blower motor.

The EBTD board also contains a speedup terminal to reduce the delays during troubleshooting of the unit. When this terminal is shorted to the common terminal, “C”, on the EBTD board, the delay ON time is reduced to 3 seconds and the delay OFF time is reduced to 5 second.

Two additional terminals, M1 and M2, are on the EBTD board. These terminals are used to connect the unused leads from the blower motor and have no affect on the board’s operation.

Checking Compressor



WARNING

HERMETIC COMPRESSOR ELECTRICAL TERMINAL VENTING CAN BE DANGEROUS. WHEN INSULATING MATERIAL WHICH SUPPORTS A HERMETIC COMPRESSOR OR ELECTRICAL TERMINAL SUDDENLY DISINTEGRATES DUE TO PHYSICAL ABUSE OR AS A RESULT OF AN ELECTRICAL SHORT BETWEEN THE TERMINAL AND THE COMPRESSOR HOUSING, THE TERMINAL MAY BE EXPELLED, VENTING THE VAPOR AND LIQUID CONTENTS OF THE COMPRESSOR HOUSING AND SYSTEM.

If the compressor terminal PROTECTIVE COVER and gasket (if required) are not properly in place and secured, there is a remote possibility if a terminal vents, that the vaporous and liquid discharge can be ignited, spouting flames several feet, causing potentially severe or fatal injury to anyone in its path.

This discharge can be ignited external to the compressor if the terminal cover is not properly in place and if the discharge impinges on a sufficient heat source.

Ignition of the discharge can also occur at the venting terminal or inside the compressor, if there is sufficient contaminant air present in the system and an electrical arc occurs as the terminal vents.

SERVICING

Ignition cannot occur at the venting terminal without the presence of contaminant air, and cannot occur externally from the venting terminal without the presence of an external ignition source.

Therefore, proper evacuation of a hermetic system is essential at the time of manufacture and during servicing.

To reduce the possibility of external ignition, all open flame, electrical power, and other heat sources should be extinguished or turned off prior to servicing a system.



Resistance Test

Each compressor is equipped with an internal overload.

The line break internal overload senses both motor amperage and winding temperature. High motor temperature or amperage heats the disc causing it to open, breaking the common circuit within the compressor on single phase units.

Heat generated within the compressor shell, usually due to recycling of the motor, high amperage or insufficient gas to cool the motor, is slow to dissipate. Allow at least three to four hours for it to cool and reset, then retest.

Fuse, circuit breaker, ground fault protective device, etc. has not tripped -

 WARNING
HIGH VOLTAGE! DISCONNECT ALL POWER BEFORE SERVICING OR INSTALLING. MULTIPLE POWER SOURCES MAY BE PRESENT. FAILURE TO DO SO MAY CAUSE PROPERTY DAMAGE, PERSONAL INJURY OR DEATH.

1. Remove the leads from the compressor terminals.

 WARNING
HERMETIC COMPRESSOR ELECTRICAL TERMINAL VENTING CAN BE DANGEROUS. WHEN INSULATING MATERIAL WHICH SUPPORTS A HERMETIC COMPRESSOR OR ELECTRICAL TERMINAL SUDDENLY DISINTEGRATES DUE TO PHYSICAL ABUSE OR AS A RESULT OF AN ELECTRICAL SHORT BETWEEN THE TERMINAL AND THE COMPRESSOR HOUSING, THE TERMINAL MAY BE EXPELLED, VENTING THE VAPOR AND LIQUID CONTENTS OF THE COMPRESSOR HOUSING AND SYSTEM.

2. Using an ohmmeter, test continuity between terminals S-R, C-R, and C-S, on single phase units or terminals T2, T2 and T3, on 3 phase units.

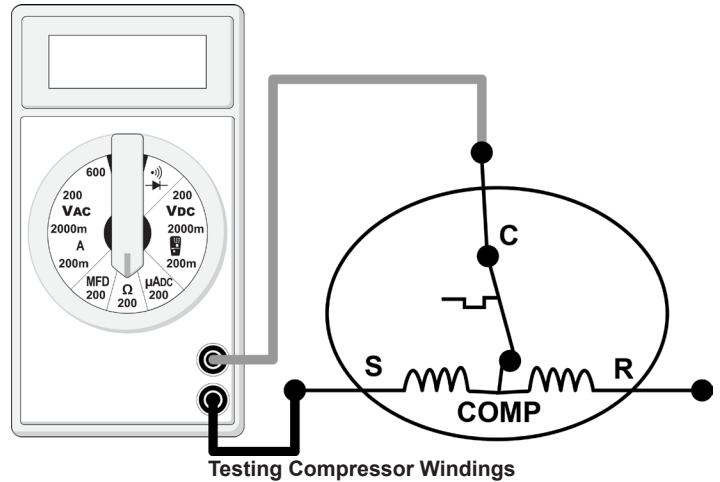

If either winding does not test continuous, replace the compressor.

NOTE: If an open compressor is indicated, allow ample time for the internal overload to reset before replacing compressor.

Ground Test

If fuse, circuit breaker, ground fault protective device, etc., has tripped, this is a strong indication that an electrical problem exists and must be found and corrected. The circuit protective device rating must be checked, and its maximum rating should coincide with that marked on the equipment nameplate.

With the terminal protective cover in place, it is acceptable to replace the fuse or reset the circuit breaker ONE TIME ONLY to see if it was just a nuisance opening. If it opens again, DO NOT continue to reset.

Disconnect all power to unit, making sure that **all** power legs are open.

1. DO NOT remove protective terminal cover. Disconnect the three leads going to the compressor terminals at the nearest point to the compressor.
2. Identify the leads and using an ohmmeter on the R x 10,000 scale or the highest resistance scale on your ohmmeter check the resistance between each of the three leads separately to ground (such as an unpainted tube on the compressor).
3. If a ground is indicated, then carefully remove the compressor terminal protective cover and inspect for loose leads or insulation breaks in the lead wires.
4. If no visual problems indicated, carefully remove the leads at the compressor terminals.
5. Carefully retest for ground, directly between compressor terminals and ground.

SERVICING

- If ground is indicated, replace the compressor. The resistance reading should be infinity. If there is any reading on meter, there is some continuity to ground and compressor should be considered defective.

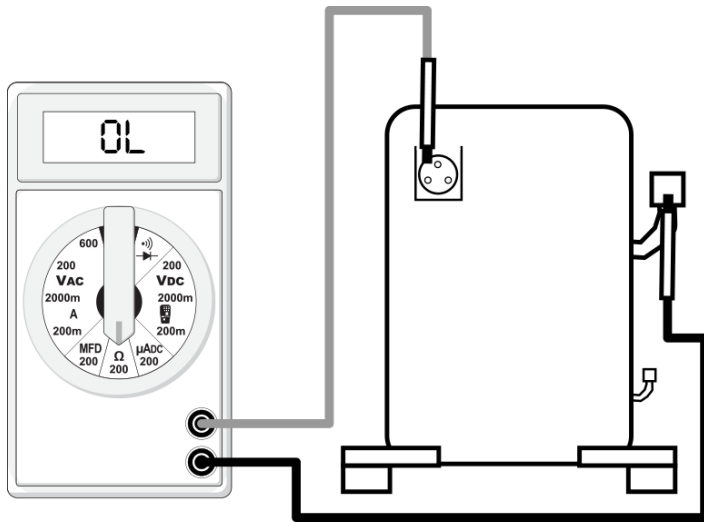

Compressor Ground Test



WARNING

DAMAGE CAN OCCUR TO THE GLASS EMBEDDED TERMINALS IF THE LEADS ARE NOT PROPERLY REMOVED. THIS CAN RESULT IN TERMINAL AND HOT OIL DISCHARGING.

Unloader Test Procedure (2 Stage Compressors Only)

A nominal 24-volt direct current coil activates the compressor internal unloader solenoid. The input control circuit voltage must be 18 to 28 volt ac (remove). The coil power requirement is 5 VA. The external electrical connection is made with a molded plug assembly. This plug contains a full wave rectifier to supply direct current to the unloader coil. The measured DC voltage at the connectors in the plug should be 15 to 27 volt dc.

Unloader Test Procedure

If it is suspected that the unloader is not working, the following methods may be used to verify operation.

- Operate the system and measure compressor amperage. Cycle the unloader ON and OFF at 10 second intervals. The compressor amperage should increase when switching from part-load to full-load and decrease when switching from full-load to part-load. The percent change depends on the operating conditions and voltage, but should be at least 25 percent.
- If step one does not give the expected results, shut unit off. Apply 18 to 28 volt ac to the unloader molded plug leads and listen for a click as the solenoid pulls

- Remove power and listen for another click as the unloader returns to its original position.
- If clicks can't be heard, shut off power to the unit and remove the control circuit molded plug from the compressor and measure the unloader coil resistance (connections on the compressor). The solenoid coil should have continuity and not be grounded or have infinite resistance. If the coil resistance is infinite, zero, or grounded, the compressor must be replaced.
- Next check the molded plug.
 - Voltage check: Apply control voltage to the plug wires (18 to 28 volt ac). The measured dc voltage at the female connectors in the plug should be around 15 to 27 vdc.
 - Resistance check: Measure the resistance from the end of one molded plug lead to either of the two female connectors in the plug. One of the connectors should read close to zero ohms while the other should read infinity. Repeat with other wire. The same female connector as before should read zero while the other connector again reads infinity. Reverse polarity on the ohmmeter leads and repeat. The female connector that read infinity previously should now read close to zero ohms.

Replace plug if either of these test methods doesn't show the desired results.

Operation Test

If the voltage, capacitor, overload and motor winding test fail to show the cause for failure:



WARNING

HIGH VOLTAGE!
DISCONNECT ALL POWER BEFORE SERVICING OR INSTALLING. MULTIPLE POWER SOURCES MAY BE PRESENT. FAILURE TO DO SO MAY CAUSE PROPERTY DAMAGE, PERSONAL INJURY OR DEATH.



- Remove unit wiring from disconnect switch and wire a test cord to the disconnect switch.

NOTE: The wire size of the test cord must equal the line wire size and the fuse must be of the proper size and type.

- With the protective terminal cover in place, use the three leads to the compressor terminals that were disconnected at the nearest point to the compressor and connect the common, start and run clips to the respective leads.
- Connect good capacitors of the right MFD and voltage rating into the circuit as shown.
- With power ON, close the switch.

SERVICING



WARNING

LINE VOLTAGE NOW PRESENT.

- If the compressor starts and continues to run, the cause for failure is somewhere else in the system.
- If the compressor fails to start - replace.

COPELAND COMPRESSOR

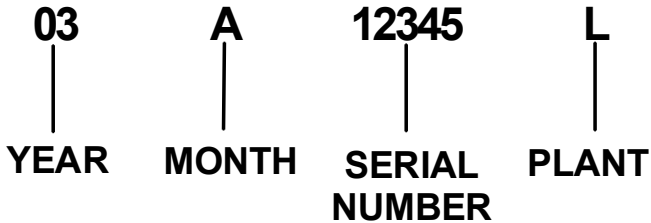

Checking 3-Phase Scroll Compressor Rotation

Verify the proper rotation of Copeland scroll compressors as follows:

NOTE: The compressor may run backwards (noisy operation) for 1 or 2 seconds at shutdown. This is normal and does not harm the compressor.

1. Install gauges and verify that the suction pressure drops while the discharge pressure increases.
2. Listen for normal compressor sound levels. Reverse rotation results in elevated or unusual sound levels.
3. Reverse rotation will result in substantially reduced amp draw from tabulated values.

To correct improper rotation, switch any two power supply leads at the outdoor unit contactor.

The 3-phase scroll compressors are direction of rotation sensitive. They will rotate in either direction depending on the phasing of the power. There is no negative impact on durability caused by operating 3-phase compressors in reversed rotation. The compressor's internal protector will trip, de-energizing the compressor. Continued operation of 3-phase scroll compressors with the rotation reversed will contribute to compressor failure. All 3-phase scroll compressors should be checked for correct phase rotation.

Testing Crankcase Heater (Optional Item)

The crankcase heater must be energized a minimum of four (4) hours before the condensing unit is operated.

Crankcase heaters are used to prevent migration or accumulation of refrigerant in the compressor crankcase during the off cycles and prevents liquid slugging or oil pumping on start up.

A crankcase heater will not prevent compressor damage due to a floodback or over charge condition.



WARNING

DISCONNECT ALL POWER BEFORE SERVICING.

1. Disconnect the heater lead in wires.
2. Using an ohmmeter, check heater continuity - should test continuous. If not, replace.

NOTE: The positive temperature coefficient crankcase heater is a 40 watt 265 voltage heater. The cool resistance of the heater will be approximately 1800 ohms. The resistance will become greater as the temperature of the compressor shell increases.

Checking Reversing Valve and Solenoid

Reversing valve used in heat pumps could potentially leak internally. Discharge gases can leak into the suction inside the valve. Compound gages will give the same symptoms as bad compressor valves or broken scroll flanks. The temperature between true suction and the suction line after the valve should not be greater than 4 degrees. Note: The center tube is always the suction line and should be cold.

Troubleshooting the Reversing Valve for Electrical Failure

1. Place unit into the cooling mode. Test for 24 volts at the solenoid. If there is no voltage present at coil, check the control voltage.
2. If voltage is present, loosen the nut on the top of the coil. Remove the coil, there should be slight resistance.
3. If the slight resistance is felt, remove the coil. As you remove the coil listen carefully, an audible click should be detected. The clicking is due to the movement of the pilot valve plunger. The absence of a clicking sound indicates the plunger is stuck.

Troubleshooting Mechanical Failures on a Reversing Valve by Pressure

1. Troubleshooting the reversing valve can be done by pressure and touch.
2. Raise the head pressure. In the cooling mode block the fan exhaust. Once head pressure has been raised, cycle between cooling and heating and see if the piston can be freed.

SERVICING

Trouble Shooting Mechanical Failures on a Reversing Valve by Temperature

1. When operating properly the valve contains refrigerant gases at certain temperatures.
2. The discharge line should be the same temperature after the valve's discharge line.
3. The true suction should be the same as the suction line after the valve. If there is a 4-degree difference, valve is leaking

When stuck in the mid-position, part of the discharge gas from the compressor is directed back to the suction side, resulting in excessively high suction pressure. An increase in the suction line temperature through the reversing valve can also be measured. Check operation of the valve by starting the system and switching the operation from COOLING to HEATING cycle.

If the valve fails to change its position, test the voltage (24V) at the valve coil terminals, while the system is on the COOLING cycle.

All heat pumps and communicating heat pumps wired in legacy - If no voltage is registered at the coil terminals, check the operation of the thermostat and the continuity of the connecting wiring from the "O" terminal of the thermostat to the unit.

Communicating heat pumps only - Check voltage (24VAC) at the non-insulated terminal E22 on the UC control board (RVS on silkscreen) and "C" terminal on the 7-pin or 4-pin connector on the UC control.

If voltage is registered at the coil, tap the valve body lightly while switching the system from HEATING to COOLING, etc. If this fails to cause the valve to switch positions, remove the coil connector cap and test the continuity of the reversing valve solenoid coil. If the coil does not test continuous - replace it.

If the coil test continuous and 24 volts is present at the coil terminals, the valve is inoperative - replace it.

Testing Defrost Control

To check the defrost control for proper sequencing, proceed as follows: With power ON; unit not running.

1. Jumper defrost thermostat by placing a jumper wire across the terminals "DFT" and "R"/"R-DFT" at defrost control board.
2. Remove jumper from timer pins and jump across test pins on defrost control board. NOTE: Do not use screwdriver or field supplied jumper to test the control.

3. Set thermostat to call for heating. System should go into defrost within 21 seconds
4. Immediately remove jumper from test pins.
5. Using VOM check for voltage across terminals "C & O". Meter should read 24 volts.
6. Using VOM check for voltage across fan terminals DF1 and DF2 on the board. You should read line voltage (208-230 VAC) indicating the relay is open in the defrost mode.
7. Using VOM check for voltage across "W"/"W2" & "C" terminals on the board. You should read 24 volts.
8. If not as above, replace control board.
9. Set thermostat to off position and disconnect power. Remove jumper from defrost thermostat and replace timer jumper to the desired defrost time.

NOTE: Remove jumper across defrost thermostat before returning system to service.

Testing Defrost Thermostat

1. Install a thermocouple type temperature test lead on the tube adjacent to the defrost control. Insulate the lead point of contact.
2. Check the temperature at which the control closes its contacts by lowering the temperature of the control. Part # 0130M00009P which is used on 2 and 2.5 ton units should close at $34^{\circ}\text{F} \pm 5^{\circ}\text{F}$. Part # 0130M00001P or B1370803 which is used on 3 thru 5 ton units should close at $31^{\circ}\text{F} \pm 3^{\circ}\text{F}$.
3. Check the temperature at which the control closes its contacts by lowering the temperature of the control. Part # 0130M00085, which is used on units with 5 mm coils, should close at $30^{\circ}\text{F} \pm 5^{\circ}\text{F}$.
4. Check the temperature at which the control opens its contacts by raising the temperature of the control. Part #0130M00009P which is used on 2 and 2.5 ton units should open at $60^{\circ}\text{F} \pm 5^{\circ}\text{F}$. Part # 0130M00001P or B1370803 which is used on 3 thru 5 ton units should open at $75^{\circ}\text{F} \pm 6^{\circ}\text{F}$.
5. Check the temperature at which the control opens its contacts by raising the temperature of the control. Part # 0130M00085, which is used on units with 5 mm coils, should open at $60^{\circ}\text{F} \pm 5^{\circ}\text{F}$.
6. If not as above, replace control.

Checking Heater Limit Control(s) (Optional Electric Heaters)

Each individual heater element is protected with an automatic rest limit control connected in series with each element to prevent overheating of components in case of low airflow. This limit control will open its circuit at approximately 150°F . to 160°F and close at approximately 110°F .

SERVICING



WARNING

DISCONNECT ALL POWER BEFORE SERVICING.

7. Remove the wiring from the control terminals.
8. Using an ohmmeter test for continuity across the normally closed contacts. No reading indicates the control is open - replace if necessary. Make sure the limits are cool before testing.

If Found Open - Replace - Do Not Wire Around.

Checking Heater Elements

Optional electric heaters may be added, in the quantities shown in the spec sheet for each model unit, to provide electric resistance heating. Under no condition shall more heaters than the quantity shown be installed.



WARNING

HIGH VOLTAGE!
DISCONNECT ALL POWER BEFORE SERVICING OR INSTALLING. MULTIPLE POWER SOURCES MAY BE PRESENT. FAILURE TO DO SO MAY CAUSE PROPERTY DAMAGE, PERSONAL INJURY OR DEATH.



1. Disassemble and remove the heating element(s).
2. Visually inspect the heater assembly for any breaks in the wire or broken insulators.
3. Using an ohmmeter, test the element for continuity - no reading indicates the element is open. Replace as necessary.

Electric Heater (Optional Item)

Optional electric heaters may be added, in the quantities shown in the specifications section, to provide electric resistance heating. Under no condition shall more heaters than the quantity shown be installed.

The low voltage circuit in the air handler is factory wired and terminates at the location provided for the electric heater(s). A minimum of field wiring is required to complete the installation.

Other components such as a Heating/Cooling Thermostat and Outdoor Thermostats are available to complete the installation.

The system CFM can be determined by measuring the static pressure external to the unit. The installation manual supplied with the blower coil, or the blower performance table in the service manual, shows the CFM for the static measured.

Alternately, the system CFM can be determined by operating the electric heaters and indoor blower WITHOUT having the compressor in operation. Measure the temperature rise as close to the blower inlet and outlet as possible.

If other than a 240V power supply is used, refer to the **BTUH CAPACITY CORRECTION FACTOR** chart below.

BTUH CAPACITY CORRECTION FACTOR				
SUPPLY VOLTAGE	250	230	220	208
MULTIPLICATION FACTOR	1.08	.92	.84	.75

EXAMPLE: Five (5) heaters provide 24.0 KW at the rated 240V. Our actual measured voltage is 220V, and our measured temperature rise is 42°F. Find the actual CFM:

Answer: 24.0KW, 42°F Rise, 240 V = 1800 CFM from the **TEMPERATURE RISE** chart on the right.

Heating output at 220 V = 24.0KW x 3.413 x .84 = 68.8 MBH.

Actual CFM = 1800 x .84 Corr. Factor = 1400 CFM.

NOTE: The temperature rise table is for sea level installations. The temperature rise at a particular KW and CFM will be greater at high altitudes, while the external static pressure at a particular CFM will be less.

TEMPERATURE RISE (°F) @ 240V								
CFM	3.0 kW	4.8 kW	7.2 kW	9.6 kW	14.4 kW	19.2 kW	24.0 kW	28.8 kW
600	16	25	38	51	-	-	-	-
700	14	22	33	43	-	-	-	-
800	12	19	29	38	57	-	-	-
900	11	17	26	34	51	-	-	-
1000	10	15	23	30	46	-	-	-
1100	9	14	21	27	41	55	-	-
1200	8	13	19	25	38	50	-	-
1300	7	12	18	23	35	46	-	-
1400	7	11	16	22	32	43	54	65
1500	6	10	15	20	30	40	50	60
1600	6	9	14	19	28	38	47	57
1700	6	9	14	18	27	36	44	53
1800	5	8	13	17	25	34	42	50
1900	5	8	12	16	24	32	40	48
2000	5	8	12	15	23	30	38	45
2100	5	7	11	14	22	29	36	43
2200	4	7	11	14	21	27	34	41
2300	4	7	10	13	20	26	33	39

SERVICING

ELECTRIC HEATER CAPACITY BTUH								
HTR KW	3.0 KW	4.7 KW	6.0 KW	7.0 KW	9.5 KW	14.2 KW	19.5 KW	21.0 KW
BTUH	10200	16200	20400	23800	32400	48600	66500	71600

FORMULAS:

Heating Output = KW x 3413 x Corr. Factor

Actual CFM = CFM (from table) x Corr. Factor

BTUH = KW x 3413

BTUH = CFM x 1.08 x Temperature Rise (T)

$$CFM = \frac{KW \times 3413}{1.08 \times T}$$

$$T = \frac{BTUH}{CFM \times 1.08}$$

Checking Heater Limit Control(s)

Each individual heater element is protected with a limit control device connected in series with each element to prevent overheating of components in case of low airflow. This limit control will open its circuit at approximately 150°F.

 **WARNING**

HIGH VOLTAGE!
DISCONNECT ALL POWER BEFORE SERVICING OR INSTALLING. MULTIPLE POWER SOURCES MAY BE PRESENT. FAILURE TO DO SO MAY CAUSE PROPERTY DAMAGE, PERSONAL INJURY OR DEATH.



1. Remove the wiring from the control terminals.
2. Using an ohmmeter, test for continuity across the normally closed contacts. No reading indicates the control is open - replace if necessary.

If Found Open - Replace - Do Not Wire Around.

Checking Heater Fuse Link (Optional Electric Heaters)

Each individual heater element is protected with a one time fuse link which is connected in series with the element. The fuse link will open at approximately 333°.

 **WARNING**

DISCONNECT ALL POWER BEFORE SERVICING.

1. Remove heater element assembly so as to expose fuse link.
2. Using an ohmmeter, test across the fuse link for continuity - no reading indicates the link is open. Replace as necessary.

NOTE: The link is designed to open at approximately 333°F. DO NOT WIRE AROUND - determine reason for failure.

Checking Heater Elements

 **WARNING**

DISCONNECT ALL POWER BEFORE SERVICING.

1. Disassemble and remove the heating element.
2. Visually inspect the heater assembly for any breaks in the wire or broken insulators.
3. Using an ohmmeter, test the element for continuity - no reading indicates the element is open. Replace as necessary.

Refrigeration Repair Practice

 **DANGER**

ALWAYS REMOVE THE REFRIGERANT CHARGE IN A PROPER MANNER BEFORE APPLYING HEAT TO THE SYSTEM.

When repairing the refrigeration system:

 **WARNING**

HIGH VOLTAGE!
DISCONNECT ALL POWER BEFORE SERVICING OR INSTALLING. MULTIPLE POWER SOURCES MAY BE PRESENT. FAILURE TO DO SO MAY CAUSE PROPERTY DAMAGE, PERSONAL INJURY OR DEATH.



1. Never open a system that is under vacuum. Air and moisture will be drawn in.
2. Plug or cap all openings.
3. Remove all burrs and clean the brazing surfaces of the tubing with sand cloth or paper. Brazing materials do not flow well on oxidized or oily surfaces.
4. Clean the inside of all new tubing to remove oils and pipe chips.

SERVICING

5. When brazing, sweep the tubing with dry nitrogen to prevent the formation of oxides on the inside surfaces.
6. Complete any repair by replacing the liquid line drier in the system, evacuate and charge.

Brazing Materials

IMPORTANT NOTE: Torch heat required to braze tubes of various sizes is proportional to the size of the tube. Tubes of smaller size require less heat to bring the tube to brazing temperature before adding brazing alloy. Applying too much heat to any tube can melt the tube. Service personnel must use the appropriate heat level for the size of the tube being brazed.

NOTE: The use of a heat shield when brazing is recommended to avoid burning the serial plate or the finish on the unit. Heat trap or wet rags should be used to protect heat sensitive components such as service valves and TXV valves.

Copper to Copper Joints - Sil-Fos used without flux (alloy of 15% silver, 80% copper, and 5% phosphorous). Recommended heat 1400°F.

Copper to Steel Joints - Silver Solder used without a flux (alloy of 30% silver, 38% copper, 32% zinc). Recommended heat - 1200°F.

Standing Pressure Test (Recommended before System Evacuation)



WARNING

TO AVOID THE RISK OF FIRE OR EXPLOSION, NEVER USE OXYGEN, HIGH PRESSURE AIR OR FLAMMABLE GASES FOR LEAK TESTING OF A REFRIGERATION SYSTEM.



WARNING

TO AVOID POSSIBLE EXPLOSION, THE LINE FROM THE NITROGEN CYLINDER MUST INCLUDE A PRESSURE REGULATOR AND A PRESSURE RELIEF VALVE. THE PRESSURE RELIEF VALVE MUST BE SET TO OPEN AT NO MORE THAN 450 PSIG.

Using dry nitrogen, pressurize the system to 450 PSIG. Allow the pressure to stabilize and hold for 15 minutes (minimum). If the pressure does not drop below 450 PSIG the system is considered leak free. Proceed to system evacuation using the Deep Vacuum Method. If after 15 minutes the pressure drops below 450 PSIG follow the procedure outlined below to identify system leaks. Repeat the Standing Pressure Test.

Leak Testing (Nitrogen or Nitrogen-Traced)



WARNING

TO AVOID THE RISK OF FIRE OR EXPLOSION, NEVER USE OXYGEN, HIGH PRESSURE AIR OR FLAMMABLE GASES FOR LEAK TESTING OF A REFRIGERATION SYSTEM.



WARNING

TO AVOID POSSIBLE EXPLOSION, THE LINE FROM THE NITROGEN CYLINDER MUST INCLUDE A PRESSURE REGULATOR AND A PRESSURE RELIEF VALVE. THE PRESSURE RELIEF VALVE MUST BE SET TO OPEN AT NO MORE THAN 450 PSIG.

Leak test the system using dry nitrogen and soapy water to identify leaks. If you prefer to use an electronic leak detector, charge the system to **10 PSIG** with the appropriate system refrigerant (see Serial Data Plate for refrigerant identification). Do not use an alternative refrigerant. Using dry nitrogen finish charging the system to **450 PSIG**. Apply the leak detector to all suspect areas. When leaks are discovered, repair the leaks, and repeat the pressure test. If leaks have been eliminated proceed to system evacuation.

System Evacuation

Condensing unit liquid and suction valves are closed to contain the charge within the unit. The unit is shipped with the valve stems closed and caps installed. Do not open valves until the system is evacuated.



WARNING

REFRIGERANT UNDER PRESSURE!
FAILURE TO FOLLOW PROPER PROCEDURES MAY CAUSE PROPERTY DAMAGE, PERSONAL INJURY OR DEATH.

NOTE: Scroll compressors should never be used to evacuate or pump down a heat pump or air conditioning system.



CAUTION

PROLONGED OPERATION AT SUCTION PRESSURES LESS THAN 20 PSIG FOR MORE THAN 5 SECONDS WILL RESULT IN OVERHEATING OF THE SCROLLS AND PERMANENT DAMAGE TO THE SCROLL TIPS, DRIVE BEARINGS AND INTERNAL SEAL.

Deep Vacuum Method (Recommended)

The Deep Vacuum Method requires a vacuum pump rated for 500 microns or less. This method is an effective and efficient way of assuring the system is free of non-

SERVICING

condensable air and moisture. As an alternative, the Triple Evacuation Method is detailed in the Service Manual for this product model.

It is recommended to remove the Schrader Cores from the service valves using a core-removal tool to expedite the evacuation procedure.

1. Connect the vacuum pump, micron gauge, and vacuum rated hoses to both service valves. Evacuation must use both service valves to eliminate system mechanical seals.
2. Evacuate the system to 500 microns or less using suction and liquid service valves. Using both valves is necessary as some compressors create a mechanical seal separating the sides of the system.
3. Close pump valve and hold vacuum for 10 minutes. Typically, pressure will rise during this period. If the pressure rises to 1000 microns or less and remains steady the system is considered leak-free; proceed to startup.
4. If pressure rises above 1000 microns but holds steady below 2000 microns, moisture and/or non-condensable may be present or the system may have a small leak. Return to step 2: If the same result is encountered check for leaks as previously indicated and repair as necessary then repeat evacuation.
5. If pressure rises above 2000 microns, a leak is present. Check for leaks as previously indicated and repair as necessary then repeat evacuation.

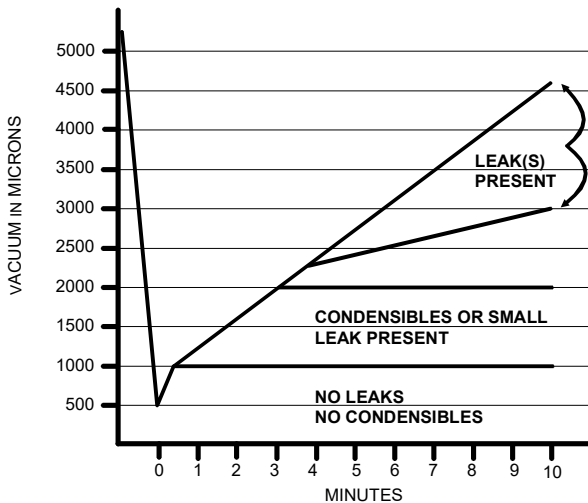



Triple Evacuation Method (Alternate)

1. Evacuate the system to 4000 microns and hold for 15 minutes. Break the vacuum with dry nitrogen, bring the system pressure to 2-3 PSIG and hold for 20 minutes. Release the nitrogen.
2. Evacuate to 1500 microns and hold for 20 minutes. Break the vacuum with dry nitrogen again, bring the system pressure back to 2-3 PSIG and hold for 20 minutes.

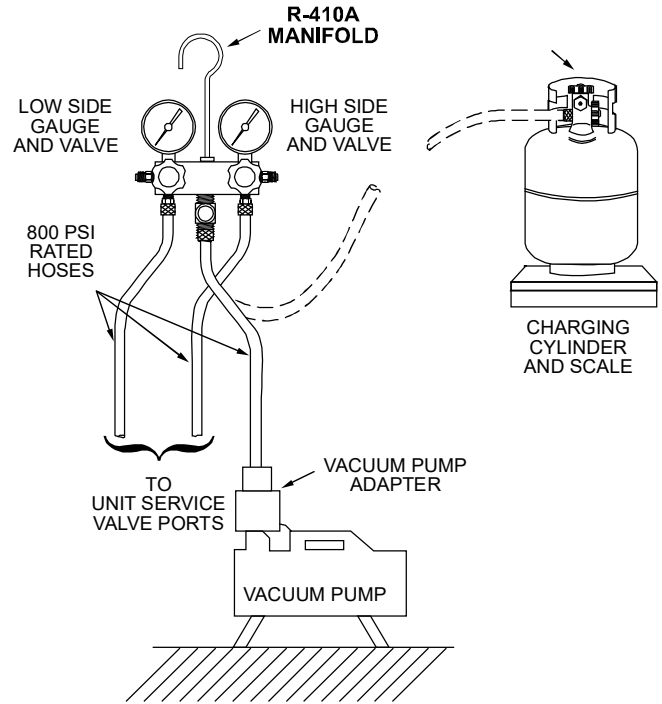
3. Evacuate the system to 500 microns and hold for 60 minutes.
4. If the pressure rises to 1000 microns or less and remains steady the system is considered leak free; proceed to start-up.



Charging

 WARNING
REFRIGERANT UNDER PRESSURE! <ul style="list-style-type: none"> • DO NOT OVERCHARGE SYSTEM WITH REFRIGERANT. • DO NOT OPERATE UNIT IN A VACUUM OR AT NEGATIVE PRESSURE. FAILURE TO FOLLOW PROPER PROCEDURES MAY CAUSE PROPERTY DAMAGE, PERSONAL INJURY OR DEATH.
 CAUTION
USE REFRIGERANT CERTIFIED TO AHRI STANDARDS. USED REFRIGERANT MAY CAUSE COMPRESSOR DAMAGE AND IS NOT COVERED UNDER THE WARRANTY. MOST PORTABLE MACHINES CANNOT CLEAN USED REFRIGERANT TO MEET AHRI STANDARDS.
 CAUTION
DAMAGE TO THE UNIT CAUSED BY OPERATING THE COMPRESSOR WITH THE SUCTION VALVE CLOSED IS NOT COVERED UNDER THE WARRANTY AND MAY CAUSE SERIOUS COMPRESSOR DAMAGE.

Charge the system with the exact amount of refrigerant. Refer to the specification section or check the unit nameplates for the correct refrigerant charge. An inaccurately charged system will cause future problems.

SERVICING

NOTE: R410A should be drawn out of the storage container or drum in liquid form due to its fractionation properties, but should be “Flashed” to its gas state before entering the system. There is commercially available restriction devices that fit into the system charging hose set to accomplish this. DO NOT charge liquid R410A into the compressor.

NOTE: Power must be supplied to the 18 SEER outdoor units containing ECM motors before the power is applied to the indoor unit. Sending a low voltage signal without high voltage power present at the outdoor unit can cause malfunction of the control module on the ECM motor.

Adequate refrigerant charge for the matching evaporator coil or air handler and 15 feet of line set is supplied with the condensing unit. If using evaporator coils or air handlers other than HSVTC coil it may be necessary to add or remove refrigerant to attain proper charge. If line set exceeds 15 feet in length, refrigerant should be added at .6 ounces per foot of liquid line.

NOTE: The outdoor temperature should be 60°F or higher when charging the unit. Charge should always be checked using subcooling when using TXV equipped indoor coil to verify proper charge.

When opening valves with retainers, open each valve only until the top of the stem is 1/8” from the retainer. To avoid loss of refrigerant, DO NOT apply pressure to the retainer. When opening valves without a retainer remove service valve cap and insert a hex wrench into the valve stem and back out the stem by turning the hex wrench counterclockwise. Open the valve until it contacts the rolled lip of the valve body.

NOTE: These are not back-seating valves. It is not necessary to force the stem tightly against the rolled lip.

Break vacuum by fully opening liquid service valve.

After the refrigerant charge has bled into the system, open the suction service valve. The service valve cap is the secondary seal for the valves and must be properly tightened to prevent leaks. Make sure cap is clean and apply refrigerant oil to threads and sealing surface on inside of cap. Tighten cap finger-tight and then tighten additional 1/8 of a turn (1 wrench flat), or to the following specification, to properly seat the sealing surfaces.

NOTE: Adequate refrigerant charge for the matching HSVTC evaporator coil or air handler and 15 feet of line set is supplied with the outdoor unit.

EXPANSION VALVE SYSTEM

NOTE: Units matched with indoor coils equipped with non-adjustable TXV should be charged by subcooling only.

NOTE: The TXV should NOT be adjusted at light load conditions 55° to 60°F. Use the following guidelines and methods to check unit operation and ensure that the refrigerant charge is within limits. Charge the unit on low stage.

Final Charge Adjustment

Airflow and Total Static Pressure for the indoor unit should be verified before attempting to charge system.

1. Total static pressure is .5” WC or less.
2. Airflow is correct for installed unit.
3. Airflow tables are in the installation manual and Spec Sheet for Indoor Unit.
4. Complete charging information are in Service Manual RS6200006.

NOTE: Superheat adjustments should not be made until indoor ambient conditions have stabilized. This could take up to 24 hours depending on indoor temperature and humidity. Before checking superheat run the unit in cooling for 10-15 minutes or until refrigerant pressures stabilize. Use the following guidelines and methods to check unit operation and ensure that the refrigerant charge is within limits.

Units matched with indoor coils equipped with a non-adjustable TXV should be charged by Subcooling only. Superheat on indoor coils with adjustable TXV valves are factory set and no adjustment is normally required during startup. Only in unique applications due to refrigerant line length, differences in height between the indoor and outdoor unit and refrigerant tubing sizes or poor performance should Superheat setting require adjustment. These adjustments should only be performed by qualified service personnel. For detailed charge and TXV adjustments refer to the appropriate Service Manual.

Units Equipped with Adjustable Expansion Valves should be charged by Subcooling and Superheat adjusted only if necessary.

1. Purge gauge lines. Connect service gauge manifold to base-valve service ports. Run the system in low stage at least 10 minutes to allow pressure to stabilize.
2. Temporarily install a thermometer on the liquid line at the liquid line service valve and 4-6” from the compressor on the suction line. Ensure the thermometer makes adequate contact and is insulated

SERVICING

for best possible readings. Use liquid line temperature to determine subcooling and vapor temperature to determine superheat.

3. Check subcooling and superheat. Systems with TXV application should have a subcooling of 5 to 7°F and superheat of 7 to 9°F.

SEER2 Units TXV-based systems should have a Subcooling value of 8°F +/- 1°F. In two-stage compressor systems, targeted Subcool value is 6°F +/- 1°F.

NOTE: To adjust superheat, turn the valve stem clockwise to increase and counter clockwise to decrease.

4. If subcooling and superheat are low, adjust TXV to 7 to 9°F superheat, and then check subcooling.
5. If subcooling is low and superheat is high, add charge to raise subcooling to 5 to 7°F then check superheat.
6. If subcooling and superheat are high, adjust TXV valve to 7 to 9°F superheat, then check subcooling.
7. If subcooling is high and superheat is low, adjust TXV valve to 7 to 9°F superheat and remove charge to lower the subcooling to 5 to 7°F.

Adjust Superheat: Only Applicable to Adjustable TXV. (Only if necessary.)

Superheat can also be utilized to best verify charge levels with an adjustable TXV and adjust (only if necessary), when needed in unique applications due to refrigerant line length, differences in height between the indoor and outdoor unit and refrigerant tubing sizes. These adjustments should be performed by qualified service personnel.

Advanced Adjustment Recommendations

SUPERHEAT FORMULA = SUCTION LINE TEMPERATURE - SATURATED SUCTION TEMPERATURE

1. Clamp a pipe thermometer 4-6" from compressor on suction line at the outdoor unit.
 - a. Ensure the thermometer makes adequate contact for the best possible readings.
 - b. The temperature read with the thermometer should be higher than the saturated suction temperature.
2. Measure the pressure using service gauge manifold connected to the true suction access port. Refer to the chart above to obtain saturated temperature corresponding to the measured pressure.
3. The difference between the saturated suction temperature and the recorded suction line temperature is the Superheat value.

4. TXV-based systems should have a Superheat value of 15.5°F +/- 1.5°F. In two-stage compressor systems, targeted value is 8°F +/- 1°F.
5. Adjust Superheat by turning the TXV valve stem clockwise to increase and counterclockwise to decrease.
 - a. If Subcooling and Superheat are low, adjust the TXV to the superheat value in step 4 and then check Subcooling.
 - b. If Subcooling is low and Superheat is high, add charge to raise Subcooling to 8°F +/- 1°F then check Superheat. In two-stage compressor systems, targeted Subcool value is 6°F +/- 1°F.
 - c. If Subcooling and Superheat are high, adjust the TXV valve to the superheat value in step 4 then check the Subcooling value.
 - d. If Subcooling is high and Superheat is low, adjust the TXV valve to the superheat value in step 4 and remove charge to lower the Subcooling to 8°F +/- 1°F. In two-stage compressor systems, targeted Subcool value is 6°F +/- 1°F.

NOTE: Do NOT adjust the charge based exclusively on suction pressure unless for general charging in the case of gross undercharge.

NOTE: Check the Schrader ports for leaks and tighten valve cores if necessary. Install caps finger tight.

NOTE: Do NOT adjust the charge based on suction pressure unless there is a gross undercharge.

SUBCOOLING FORMULA = SATURATED LIQUID TEMP. - LIQUID LINE TEMP.

NOTE: Check the Schrader ports for leaks and tighten valve cores if necessary. Install caps finger-tight.

HEAT PUMP - HEATING CYCLE

The proper method of charging a heat pump in the heat mode is by weight with the additional charge adjustments for line size, line length, and other system components. For best results on outdoor units with TXVs, superheat should be 2-5°F at 4-6" from the compressor. Make final charge adjustments in the cooling cycle.

SEER2 Heat Pump - Heating Cycle

The proper method of charging a heat pump in the heat mode is by weight with the additional charge adjustments for line size, line length, and other system components. For best results, on outdoor units with TXV's superheat should be 8°F +/- 1°F at 4 to 6" from the compressor.

SERVICING

NOTE: In system with TWO-stage compressor, make TXV adjustment in high stage. For best results adjust OD TXV to 5°F +/- 1°F. Make final charge adjustments in the cooling cycle.

Checking Compressor Efficiency

The reason for compressor inefficiency is broken or damaged scroll flanks on Scroll compressors, reducing the ability of the compressor to pump refrigerant vapor.

The condition of the scroll flanks is checked in the following manner.

1. Attach gauges to the high and low side of the system.
2. Start the system and run a "Cooling Performance Test."

If the test shows:

- a. Below normal high side pressure.
- b. Above normal low side pressure.
- c. Low temperature difference across coil.
- d. Low amp draw at compressor.

And the charge is correct. The compressor is faulty - replace the compressor.

Overfeeding

Overfeeding by the expansion valve results in high suction pressure, cold suction line, and possible liquid slugging of the compressor.

If these symptoms are observed:

1. Check for an overcharged unit by referring to the cooling performance charts in the servicing section.
2. Check the operation of the power element in the valve as explained in Checking Expansion Valve Operation.
3. Check for restricted or plugged equalizer tube.

Underfeeding

Underfeeding by the expansion valve results in low system capacity and low suction pressures.

If these symptoms are observed:

1. Check for a restricted liquid line or drier. A restriction will be indicated by a temperature drop across the drier.
2. Check the operation of the power element of the valve as described in Checking Expansion Valve Operation.

Checking Superheat

Superheat on Fixed Orifice or TXV

1. Purge gauge lines. Connect service gauge manifold to base-valve service ports. Run system at least 10 minutes to allow pressure to stabilize.

2. Temporarily install a thermometer 4-6" from the compressor on the suction line. Ensure the thermometer makes adequate contact and is insulated for best possible readings. Use vapor temperature to determine superheat.
3. Refer to the superheat table provided for proper system superheat. Add charge to lower superheat or recover charge to raise superheat.
4. Disconnect manifold set, installation is complete.

SUPERHEAT FORMULA = SUCT. LINE TEMP. - SAT. SUCT. TEMP.

Pistons Used in Outdoor Heat Pump Coils				
Goodman 14 SEER Heat Pumps				
Model	Cur. Rev	Piston	Prev. Rev	Piston
G/VSZ140181	LA	.032	KF	.039
G/VSZ140241	LA	.047	KH	.047
G/VSZ140301	KG	.052	KF	.052
G/VSZ140361	KE	.059	LA	.059
G/VSZ140421	KE	.061	KD	.061
G/VSZ140481	KF	.065	KE	.065
G/VSZ140491	KE	.065	KD	.065
G/VSZ140601	KE	.065	KD	.065
Amana 14 SEER Heat Pumps				
Model	Cur. Rev	Piston	Prev. Rev	Piston
ASZ140181	KE	.039	KD	.039
ASZ140241	KD	.047	KC	.047
ASZ140301	KD	.052	KC	.052
ASZ140361	KD	.059	KC	.059
ASZ140381	AC	.059	n/a	.059
ASZ140421	KD	.061	KC	.061
ASZ140481	KD	.065	KC	.065
ASZ140491	KD	.065	KC	.065
ASZ140601	KC	.065	KB	.065
Amana 14 SEER Heat Pumps				
Model	Cur. Rev	Piston	Prev. Rev	Piston
ANZ140181	AE	.039	AD	.039
ANZ140241	AD	.047	AA	.047
ANZ140301	AE	.052	AD	.052
ANZ140361	AD	.059	AC	.059
ANZ140421	AD	.061	AC	.061
ANZ140481	AD	.065	AC	.065
ANZ140491	AD	.065	AC	.065
ANZ140601	AC	.065	AB	.065

SERVICING



CAUTION

TO PREVENT PERSONAL INJURY, CAREFULLY CONNECT AND DISCONNECT MANIFOLD GAUGE HOSES. ESCAPING LIQUID REFRIGERANT CAN CAUSE BURNS. DO NOT VENT REFRIGERANT TO ATMOSPHERE. RECOVER DURING SYSTEM REPAIR OR FINAL UNIT DISPOSAL.

5. Run system at least 10 minutes to allow pressure to stabilize.
6. For best results, temporarily install a thermometer on the liquid line at the liquid line service valve and 4-6" from the compressor on the suction line. Ensure the thermometer makes adequate contact and is insulated for best possible readings. Use liquid line temperature to determine sub-cooling and vapor temperature to determine superheat.

NOTE: An optional method is to locate the thermometer at the suction line service valve. Ensure the thermometer makes adequate contact and is insulated for best possible readings.

7. Refer to the superheat table provided for proper system superheat. Add charge to lower superheat or recover charge to raise superheat.

SUPERHEAT FORMULA = SUCT. LINE TEMP. - SAT. SUCT. TEMP.

EXAMPLE:

- a. Suction Pressure = 143
- b. Corresponding Temp. °F = 50
- c. Thermometer on Suction Line = 61°F

To obtain the degrees temperature of superheat, subtract 50.0 from 61.0°F.

The difference is 11° Superheat. The 11° Superheat would fall in the ± range of allowable superheat.

Subcooling on Expansion Valve System

1. Purge gauge lines. Connect service gauge manifold to base-valve service ports. Run system at least 10 minutes to allow pressure to stabilize.
2. Clamp a pipe clamp thermometer on the liquid line near the liquid line service valve and 4-6" from the compressor on the suction line.
 - a. Ensure the thermometer makes adequate contact to obtain the best possible readings.
 - b. The temperature read with the thermometer should be lower than the saturated condensing temperature.
3. The difference between the measured saturated condensing temperature and the liquid line temperature is the liquid Subcooling value.

4. TXV-based systems should have a Subcooling value of 8°F +/- 1°F.
5. Add refrigerant to increase Subcooling and remove refrigerant to decrease Subcooling.

Checking Expansion Valve Operation

1. Remove the remote bulb of the expansion valve from the suction line.
2. Start the system and cool the bulb in a container of ice water, closing the valve. As you cool the bulb, the suction pressure should fall and the suction temperature will rise.
3. Next warm the bulb in your hand. As you warm the bulb, the suction pressure should rise and the suction temperature will fall.
4. If a temperature or pressure change is noticed, the expansion valve is operating. If no change is noticed, the valve is restricted, the power element is faulty, or the equalizer tube is plugged.
5. Capture the charge, replace the valve and drier, evacuate and recharge.

Checking Restricted Liquid Line

When the system is operating, the liquid line is warm to the touch. If the liquid line is restricted, a definite temperature drop will be noticed at the point of restriction. In severe cases, frost will form at the restriction and extend down the line in the direction of the flow.

Discharge and suction pressures will be low, giving the appearance of an undercharged unit. However, the unit will have normal to high subcooling.

Locate the restriction, replace the restricted part, replace drier, evacuate and recharge.

Overcharge Of Refrigerant

An overcharge of refrigerant is normally indicated by an excessively high head pressure.

An evaporator coil, using an expansion valve metering device, will basically modulate and control a flooded evaporator and prevent liquid return to the compressor.

An evaporator coil, using a capillary tube metering device, could allow refrigerant to return to the compressor under extreme overcharge conditions. Also with a capillary tube metering device, extreme cases of insufficient indoor air can cause icing of the indoor coil and liquid return to the compressor, but the head pressure would be lower.

There are other causes for high head pressure which may be found in the "Service Problem Analysis Guide". If other causes check out normal, an overcharge or a system containing non-condensables would be indicated.

SERVICING

Pressure vs. Temperature Chart													
R-410A													
PSIG	°F	PSIG	°F	PSIG	°F	PSIG	°F	PSIG	°F	PSIG	°F	PSIG	°F
12	-37.7	114.0	37.8	216.0	74.3	318.0	100.2	420.0	120.7	522.0	137.6		
14	-34.7	116.0	38.7	218.0	74.9	320.0	100.7	422.0	121.0	524.0	137.9		
16	-32.0	118.0	39.5	220.0	75.5	322.0	101.1	424.0	121.4	526.0	138.3		
18	-29.4	120.0	40.5	222.0	76.1	324.0	101.6	426.0	121.7	528.0	138.6		
20	-36.9	122.0	41.3	224.0	76.7	326.0	102.0	428.0	122.1	530.0	138.9		
22	-24.5	124.0	42.2	226.0	77.2	328.0	102.4	430.0	122.5	532.0	139.2		
24	-22.2	126.0	43.0	228.0	77.8	330.0	102.9	432.0	122.8	534.0	139.5		
26	-20.0	128.0	43.8	230.0	78.4	332.0	103.3	434.0	123.2	536.0	139.8		
28	-17.9	130.0	44.7	232.0	78.9	334.0	103.7	436.0	123.5	538.0	140.1		
30	-15.8	132.0	45.5	234.0	79.5	336.0	104.2	438.0	123.9	540.0	140.4		
32	-13.8	134.0	46.3	236.0	80.0	338.0	104.6	440.0	124.2	544.0	141.0		
34	-11.9	136.0	47.1	238.0	80.6	340.0	105.1	442.0	124.6	548.0	141.6		
36	-10.1	138.0	47.9	240.0	81.1	342.0	105.4	444.0	124.9	552.0	142.1		
38	-8.3	140.0	48.7	242.0	81.6	344.0	105.8	446.0	125.3	556.0	142.7		
40	-6.5	142.0	49.5	244.0	82.2	346.0	106.3	448.0	125.6	560.0	143.3		
42	-4.5	144.0	50.3	246.0	82.7	348.0	106.6	450.0	126.0	564.0	143.9		
44	-3.2	146.0	51.1	248.0	83.3	350.0	107.1	452.0	126.3	568.0	144.5		
46	-1.6	148.0	51.8	250.0	83.8	352.0	107.5	454.0	126.6	572.0	145.0		
48	0.0	150.0	52.5	252.0	84.3	354.0	107.9	456.0	127.0	576.0	145.6		
50	1.5	152.0	53.3	254.0	84.8	356.0	108.3	458.0	127.3	580.0	146.2		
52	3.0	154.0	54.0	256.0	85.4	358.0	108.8	460.0	127.7	584.0	146.7		
54	4.5	156.0	54.8	258.0	85.9	360.0	109.2	462.0	128.0	588.0	147.3		
56	5.9	158.0	55.5	260.0	86.4	362.0	109.6	464.0	128.3	592.0	147.9		
58	7.3	160.0	56.2	262.0	86.9	364.0	110.0	466.0	128.7	596.0	148.4		
60	8.6	162.0	57.0	264.0	87.4	366.0	110.4	468.0	129.0	600.0	149.0		
62	10.0	164.0	57.7	266.0	87.9	368.0	110.8	470.0	129.3	604.0	149.5		
64	11.3	166.0	58.4	268.0	88.4	370.0	111.2	472.0	129.7	608.0	150.1		
66	12.6	168.0	59.0	270.0	88.9	372.0	111.6	474.0	130.0	612.0	150.6		
68	13.8	170.0	59.8	272.0	89.4	374.0	112.0	476.0	130.3	616.0	151.2		
70	15.1	172.0	60.5	274.0	89.9	376.0	112.4	478.0	130.7	620.0	151.7		
72	16.3	174.0	61.1	276.0	90.4	378.0	112.6	480.0	131.0	624.0	152.3		
74	17.5	176.0	61.8	278.0	90.9	380.0	113.1	482.0	131.3	628.0	152.8		
76	18.7	178.0	62.5	280.0	91.4	382.0	113.5	484.0	131.6	632.0	153.4		
78	19.8	180.0	63.1	282.0	91.9	384.0	113.9	486.0	132.0	636.0	153.9		
80	21.0	182.0	63.8	284.0	92.4	386.0	114.3	488.0	132.3	640.0	154.5		
82	22.1	184.0	64.5	286.0	92.8	388.0	114.7	490.0	132.6	644.0	155.0		
84	23.2	186.0	65.1	288.0	93.3	390.0	115.0	492.0	132.9	648.0	155.5		
86	24.3	188.0	65.8	290.0	93.8	392.0	115.5	494.0	133.3	652.0	156.1		
88	25.4	190.0	66.4	292.0	94.3	394.0	115.8	496.0	133.6	656.0	156.6		
90	26.4	192.0	67.0	294.0	94.8	396.0	116.2	498.0	133.9	660.0	157.1		
92	27.4	194.0	67.7	296.0	95.2	398.0	116.6	500.0	134.0	664.0	157.7		
94	28.5	196.0	68.3	298.0	95.7	400.0	117.0	502.0	134.5	668.0	158.2		
96	29.5	198.0	68.9	300.0	96.2	402.0	117.3	504.0	134.8	672.0	158.7		
98	30.5	200.0	69.5	302.0	96.6	404.0	117.7	506.0	135.2	676.0	159.2		
100	31.2	202.0	70.1	304.0	97.1	406.0	118.1	508.0	135.5	680.0	159.8		
102	32.2	204.0	70.7	306.0	97.5	408.0	118.5	510.0	135.8	684.0	160.3		
104	33.2	206.0	71.4	308.0	98.0	410.0	118.8	512.0	136.1	688.0	160.8		
106	34.1	208.0	72.0	310.0	98.4	412.0	119.2	514.0	136.4	692.0	161.3		
108	35.1	210.0	72.6	312.0	98.9	414.0	119.6	516.0	136.7	696.0	161.8		
110	35.5	212.0	73.2	314.0	99.3	416.0	119.9	518.0	137.0				
112	36.9	214.0	73.8	316.0	99.7	418.0	120.3	520.0	137.3				

*Based on ALLIED SIGNAL Data

SERVICING

REQUIRED LIQUID LINE TEMPERATURE						
LIQUID PRESSURE AT SERVICE VALVE (PSIG)	REQUIRED SUBCOOLING TEMPERATURE (°F)					
	8	10	12	14	16	18
189	58	56	54	52	50	48
195	60	58	56	54	52	50
202	62	60	58	56	54	52
208	64	62	60	58	56	54
215	66	64	62	60	58	56
222	68	66	64	62	60	58
229	70	68	66	64	62	60
236	72	70	68	66	64	62
243	74	72	70	68	66	64
251	76	74	72	70	68	66
259	78	76	74	72	70	68
266	80	78	76	74	72	70
274	82	80	78	76	74	72
283	84	82	80	78	76	74
291	86	84	82	80	78	76
299	88	86	84	82	80	78
308	90	88	86	84	82	80
317	92	90	88	86	84	82
326	94	92	90	88	86	84
335	96	94	92	90	88	86
345	98	96	94	92	90	88
354	100	98	96	94	92	90
364	102	100	98	96	94	92
374	104	102	100	98	96	94
384	106	104	102	100	98	96
395	108	106	104	102	100	98
406	110	108	106	104	102	100
416	112	110	108	106	104	102
427	114	112	110	108	106	104
439	116	114	112	110	108	106
450	118	116	114	112	110	108
462	120	118	116	114	112	110
474	122	120	118	116	114	112
486	124	122	120	118	116	114
499	126	124	122	120	118	116
511	128	126	124	122	120	118

SERVICING

If this system is observed:

1. Start the system.
2. Remove and capture small quantities of gas from the suction line dill valve until the head pressure is reduced to normal.
3. Observe the system while running a cooling performance test. If a shortage of refrigerant is indicated, then the system contains non-condensables.

Non-Condensables

If non-condensables are suspected, shut down the system and allow the pressures to equalize. Wait at least 15 minutes. Compare the pressure to the temperature of the coldest coil since this is where most of the refrigerant will be. If the pressure indicates a higher temperature than that of the coil temperature, non-condensables are present.

Non-condensables are removed from the system by first removing the refrigerant charge, replacing and/or installing liquid line drier, evacuating and recharging.

Checking Compressor Efficiency

The reason for compressor inefficiency is broken or damaged scroll flanks on Scroll compressors, reducing the ability of the compressor to pump refrigerant vapor. The condition of the scroll flanks is checked in the following manner.

1. Attach gauges to the high and low side of the system.
2. Start the system and run a "Cooling Performance Test. If the test shows:
 - a. Below normal high side pressure.
 - b. Above normal low side pressure.
 - c. Low temperature difference across coil.
 - d. Low amp draw at compressor.

And the charge is correct. The compressor is faulty – replace the compressor.

Compressor Burnout

When a compressor burns out, high temperature develops causing the refrigerant, oil and motor insulation to decompose forming acids and sludge.

If a compressor is suspected of being burned-out, attach a refrigerant hose to the liquid line dill valve and properly remove and dispose of the refrigerant.

NOTICE: Violation of EPA regulations may result in fines or other penalties.

Now determine if a burn out has actually occurred. Confirm by analyzing an oil sample using a Sporlan Acid Test Kit, AK-3 or its equivalent.

Remove the compressor and obtain an oil sample from the suction stub. If the oil is not acidic, either a burnout has not occurred or the burnout is so mild that a complete clean-up is not necessary.

If acid level is unacceptable, the system must be cleaned by using the clean-up drier method.



CAUTION

DO NOT ALLOW THE SLUDGE OR OIL TO CONTACT THE SKIN. SEVERE BURNS MAY RESULT.

NOTE: The Flushing Method using R-11 refrigerant is no longer approved by Amana® Brand Heating-Cooling.

Suction Line Drier Clean-Up Method

The POE oils used with R410A refrigerant is an excellent solvent. In the case of a burnout, the POE oils will remove any burnout residue left in the system. If not captured by the refrigerant filter, they will collect in the compressor or other system components, causing a failure of the replacement compressor and/or spread contaminants throughout the system, damaging additional components.

Install a field supplied suction line drier. This drier should be installed as close to the compressor suction fitting as possible. The filter must be accessible and be rechecked for pressure drop after the system has operated for a time. It may be necessary to use new tubing and form as required.

NOTE: At least twelve (12) inches of the suction line immediately out of the compressor stub must be discarded due to burned residue and contaminates.

1. Remove compressor discharge line strainer.
2. Remove the liquid line drier and expansion valve.
3. Purge all remaining components with dry nitrogen or carbon dioxide until clean.
4. Install new components **including** liquid line drier.
5. Braze all joints, leak test, evacuate, and recharge system.
6. Start up the unit and record the pressure drop across the drier.
7. Continue to run the system for a minimum of twelve (12) hours and recheck the pressure drop across the drier. Pressure drop should not exceed 6 PSIG.
8. Continue to run the system for several days, repeatedly checking pressure drop across the suction line drier. If the pressure drop never exceeds the 6 PSIG, the drier has trapped the contaminants. Remove the suction line drier from the system.

SERVICING

- If the pressure drop becomes greater, then it must be replaced and steps 5 through 9 repeated until it does not exceed 6 PSIG.

NOTICE: Regardless, the cause for burnout must be determined and corrected before the new compressor is started.

Refrigerant Piping

The piping of a refrigeration system is very important in relation to system capacity, proper oil return to compressor, pumping rate of compressor and cooling performance of the evaporator.

POE oils maintain a consistent viscosity over a large temperature range which aids in the oil return to the compressor; however, there will be some installations which require oil return traps. These installations should be avoided whenever possible, as adding oil traps to the refrigerant lines also increases the opportunity for debris and moisture to be introduced into the system. Avoid long running traps in horizontal suction line.

Duct Static Pressures

This minimum and maximum allowable duct static pressure for the indoor sections are found in the specifications section.

Tables are also provided for each coil, listing quantity of air (CFM) versus static pressure drop across the coil.

Too great an external static pressure will result in insufficient air that can cause icing of the coil. Too much air can cause poor humidity control and condensate to be pulled off the evaporator coil causing condensate leakage. Too much air can also cause motor overloading and in many cases this constitutes a poorly designed system.

Single Piece Air Handler External Static

To determine proper airflow, proceed as follows:

- Using a Inclined Manometer or Magnehelic gauge, measure the static pressure of the return duct at the inlet of the air handler, this will be a negative pressure (For Example: .30" wc).
- Measure the static pressure of the supply duct at the outlet of the air handler, this should be a positive pressure (For Example: .20" wc).
- Add the two readings together (For Example: .30" wc + .20" wc = .50" wc total external static pressure).

NOTE: Both readings may be taken simultaneously and read directly on the manometer if so desired.

- Consult proper air handler airflow chart for quantity of air (CFM) at the measured external static pressure.

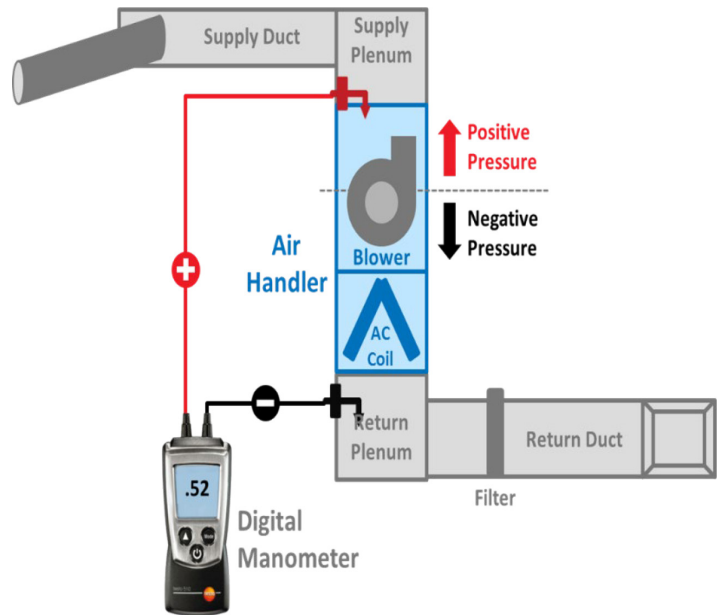

Two Piece Air Handler External Static Pressure

To determine proper airflow, proceed as follows:

- Using a Inclined Manometer or Magnehelic gauge, measure the static pressure between the outlet of the evaporator coil and the inlet of the air handler, this will be a negative pressure (For Example: .30" wc).
- Measure the static pressure of the supply duct at the outlet of the unit, this should be a positive pressure (For Example: .20" wc).
- Add the two readings together (For Example: .30" wc + .20" wc = .50" wc total static pressure).

NOTE: Both readings may be taken simultaneously and read directly on the manometer if so desired.

- Consult proper air handler airflow chart for quantity of air (CFM) at the measured external static pressure.

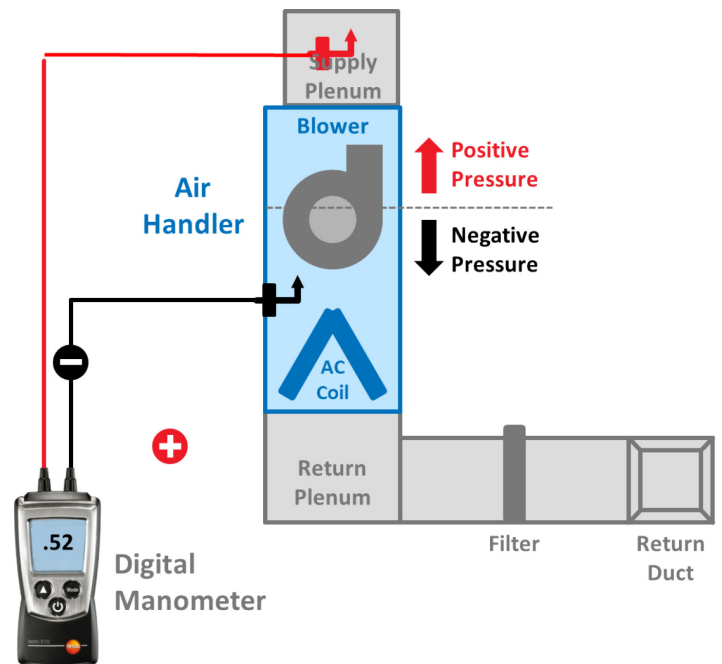

SERVICING

Furnace External Static Pressure

To determine proper airflow, proceed as follows:

1. With clean filters in the furnace, using an Inclined Manometer or Magnehelic gauge measure the static pressure of the return duct at the inlet of the furnace (Negative Pressure).
2. Measure the static pressure between the furnace and the inlet of the evaporator coil (Positive Pressure). The limit switch can be removed, and probe inserted to obtain this reading.
3. Add the two (2) readings together for total external static pressure.

NOTE: Both readings may be taken simultaneously and read directly on the manometer if so desired. If high Efficiency Air Filter or Electronic Air Cleaner is used in conjunction with the furnace, the readings must also include these components, as shown in the following drawing.

4. Consult proper airflow tables for the quantity of air (CFM).

If the total external static pressure exceeds the minimum or maximum allowable statics, check for closed dampers, registers, undersized and/or oversized poorly laid out ductwork.

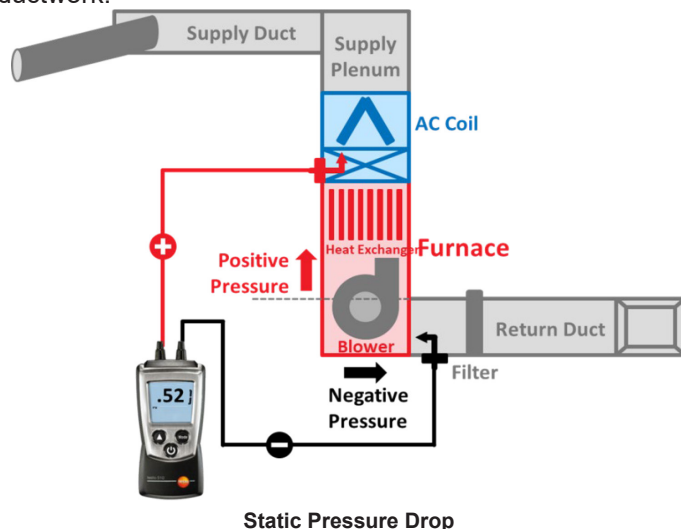

Periodic Maintenance

Motors

Indoor and Outdoor motors are permanently lubricated and do not need additional oiling.

Cleaning Outdoor Coil

1. Check for oil deposits on coil this could be an indication of possible leak. If no leak detected spray coil with ordinary household detergent.
2. Using garden hose, spray coil vertically downward with constant stream of water at moderate pressure. Keep nozzle at a 15 to 20° angle, about 3 in. from coil face. Spray so debris is washed out of coil and base pan.

3. Reinstall top cover and position blade.
4. Reconnect electrical power and check for proper operation.

Cleaning Outdoor Fan Blade

1. Check balance weights on fan blade.
2. Check fan blade setscrew for tightness.

Electrical Controls and Wiring

1. Disconnect power to both outdoor and indoor units.
2. Check all electrical connections for tightness.
3. Tighten all screws on electrical connections.
4. Connections that appear to be burned or smoky should be disassembled and cleaned all parts
5. Wire connections that appear burned and corroded should be replaced and crimp tightly to assure they do not overheat.
6. Reconnect electrical power to indoor and outdoor units and check for proper operation.

Cleaning Aluminum Coils

Evaporator coils and air handlers are equipped with an aluminum tube evaporator coil. The safest way to clean the evaporator coil is to simply flush the coil with water. This cleaning practice remains as the recommended cleaning method for both copper tube and aluminum tube residential cooling coils.

An alternate cleaning method is to use one of the products listed in the technical publication TP-109 (shipped in the literature bag with the unit) to clean the coils. The cleaners listed are the only agents deemed safe and approved for use to clean round tube aluminum coils. TP-109 is available on the web site in Partner Link > Service Toolkit.

NOTE: Ensure coils are rinsed well after use of any chemical cleaners

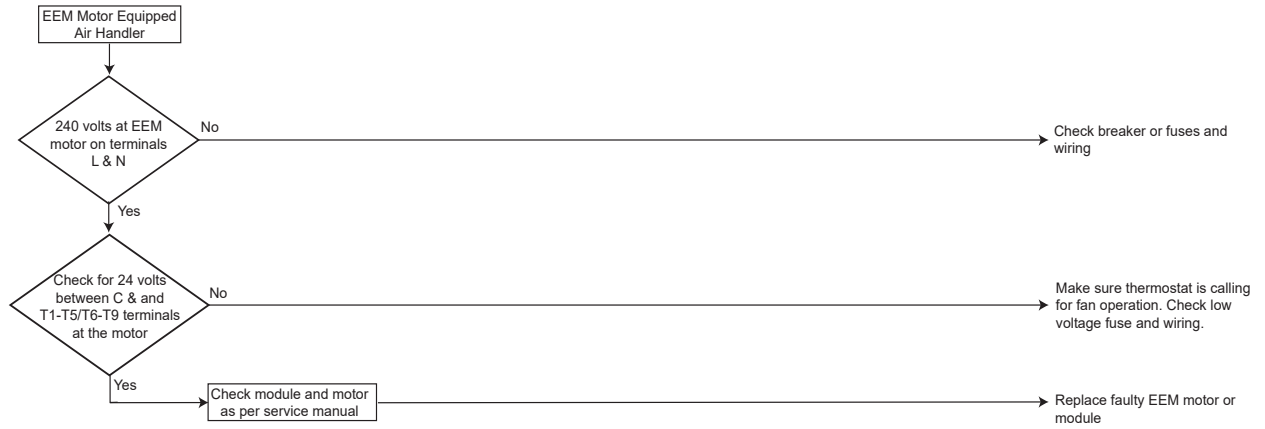

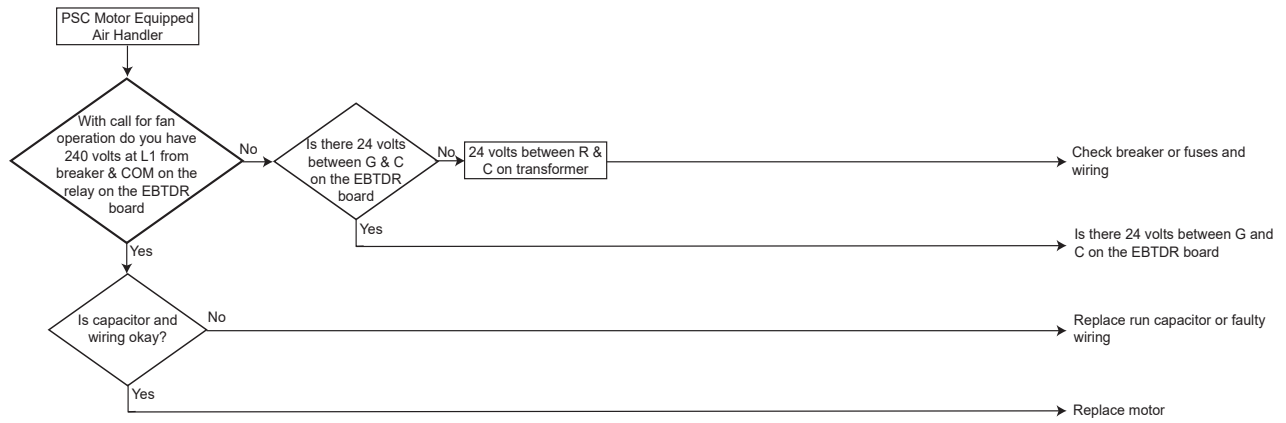

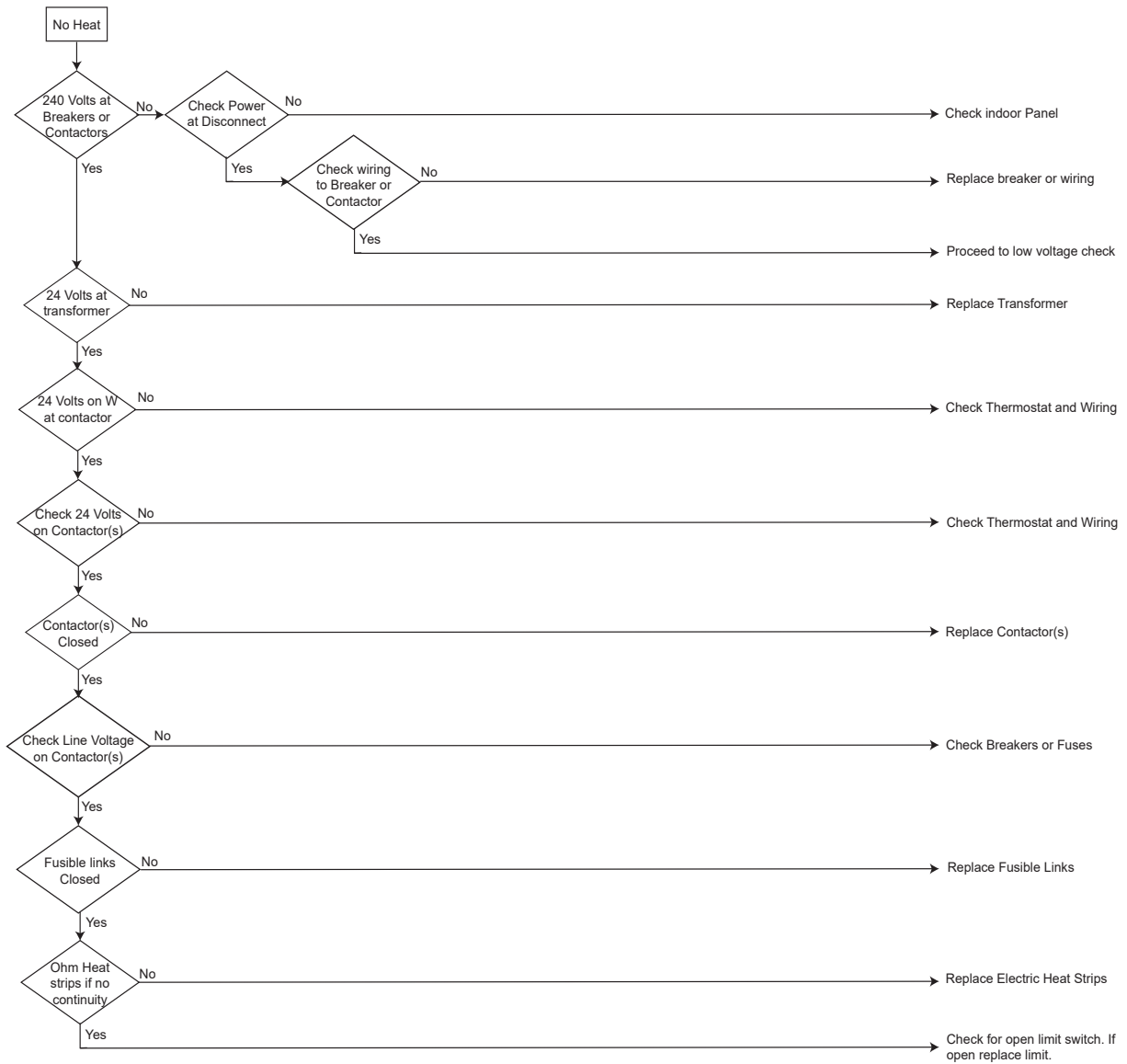

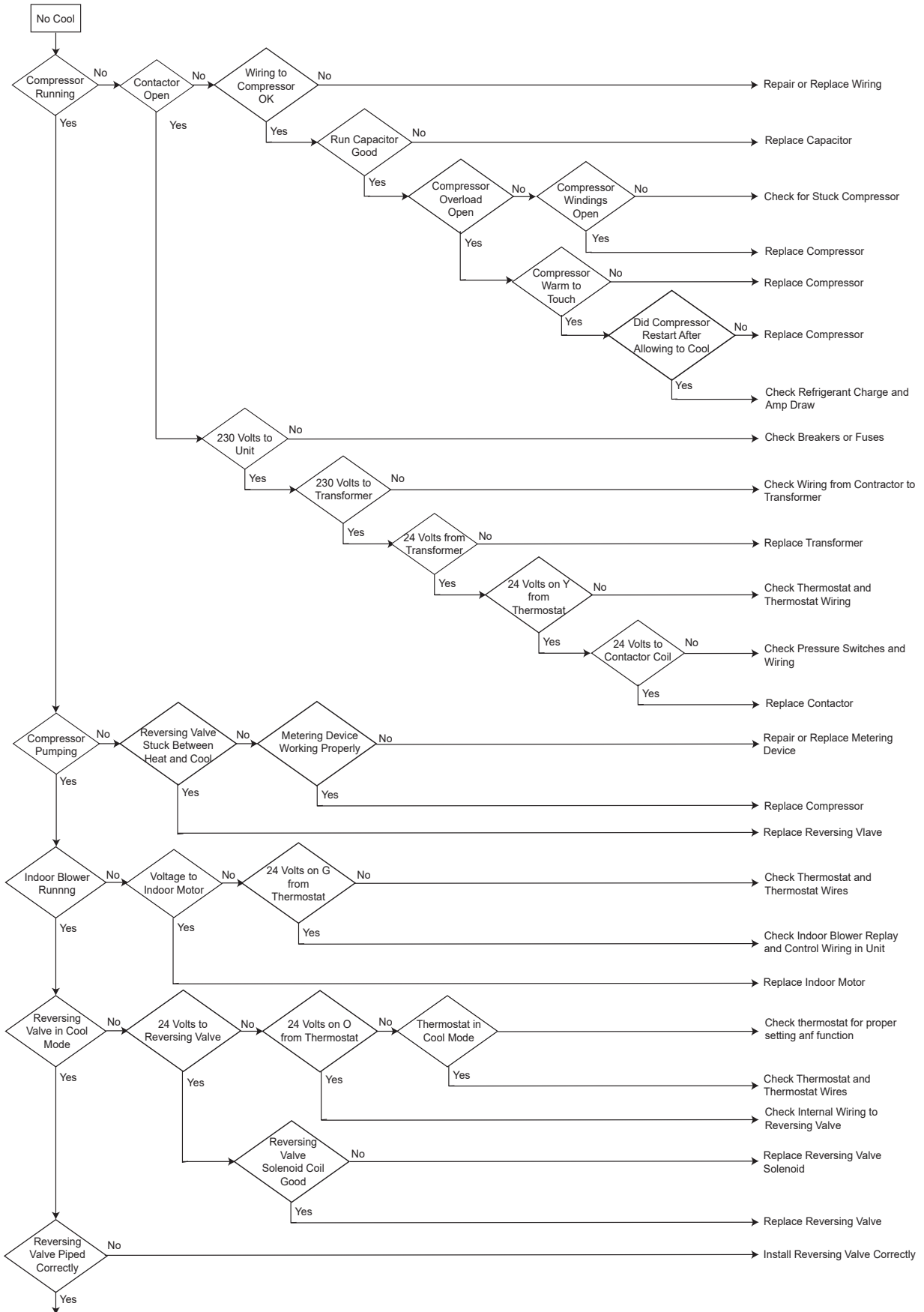

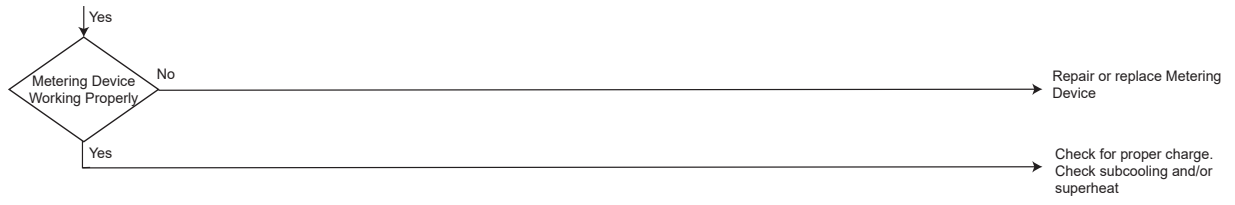

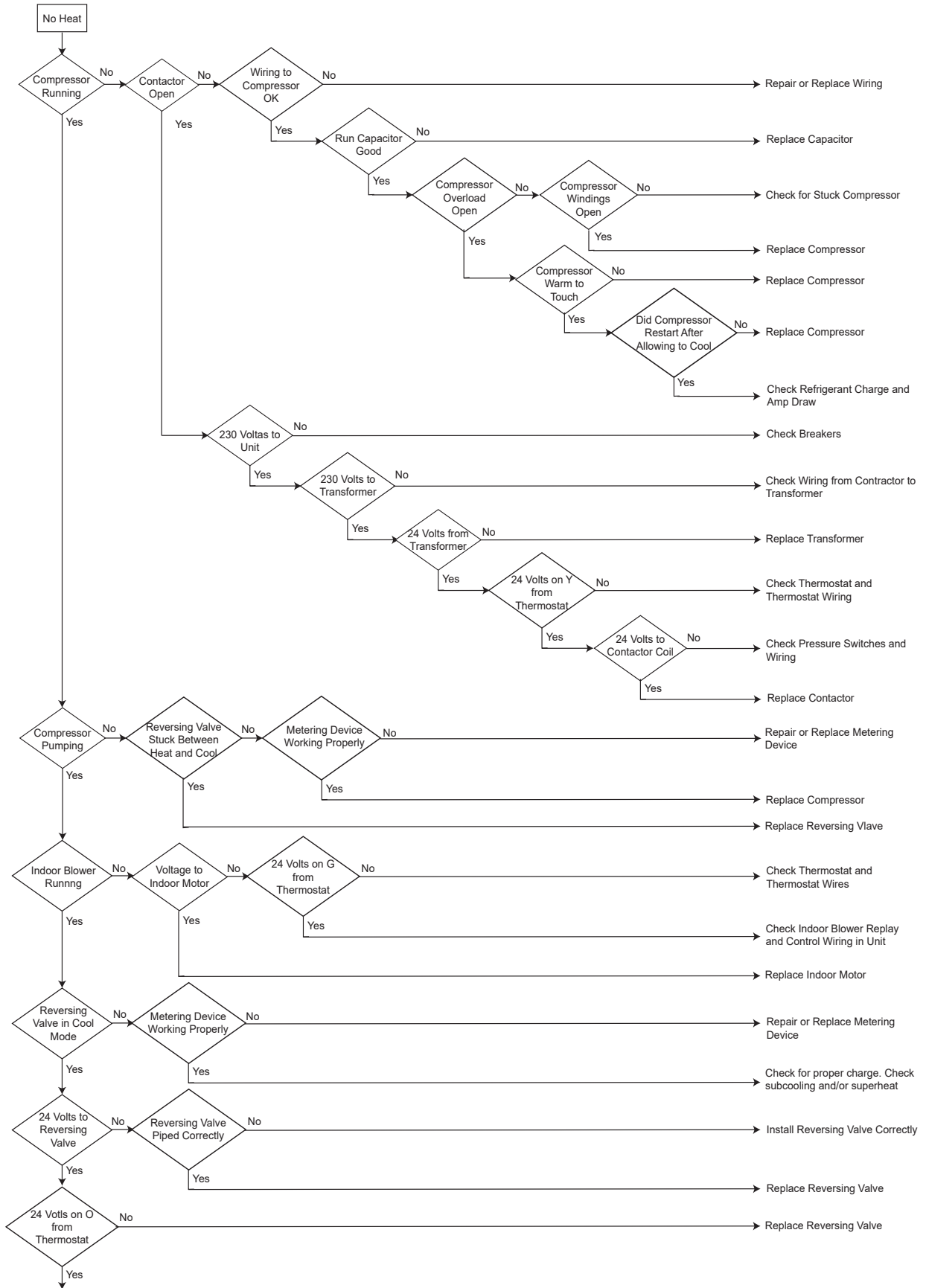

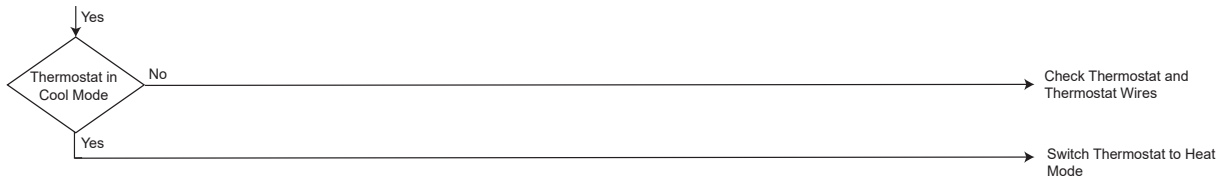

WIRING DIAGRAMS

10kw and Below, One Stage Electric Heat

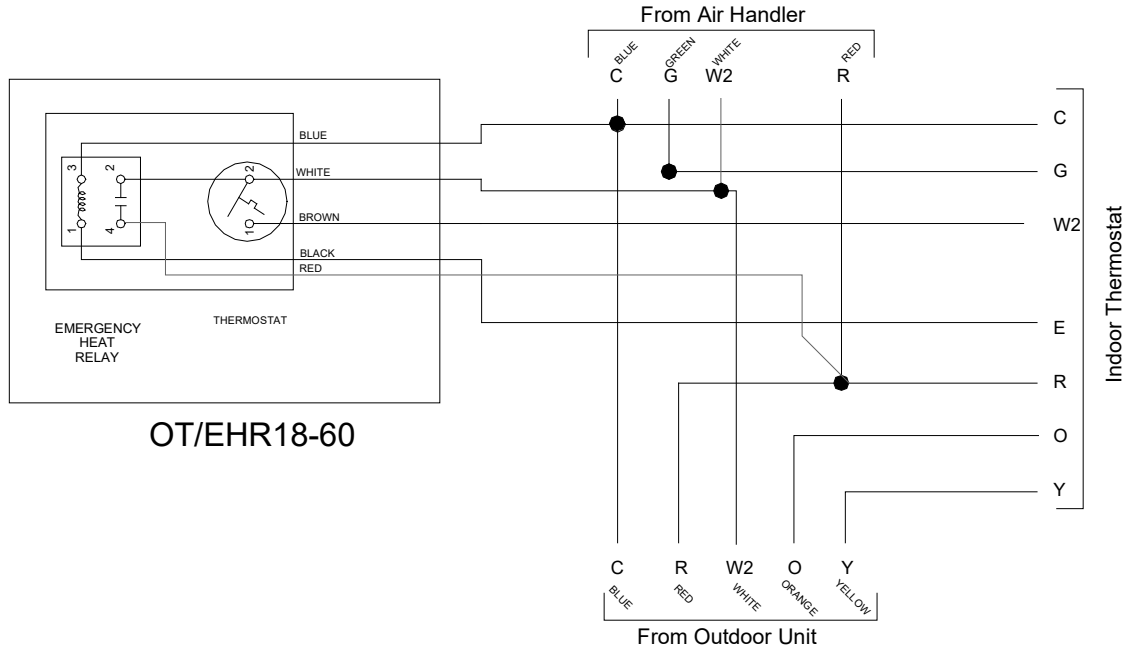

15kw and Above, Two Stage Electric Heat

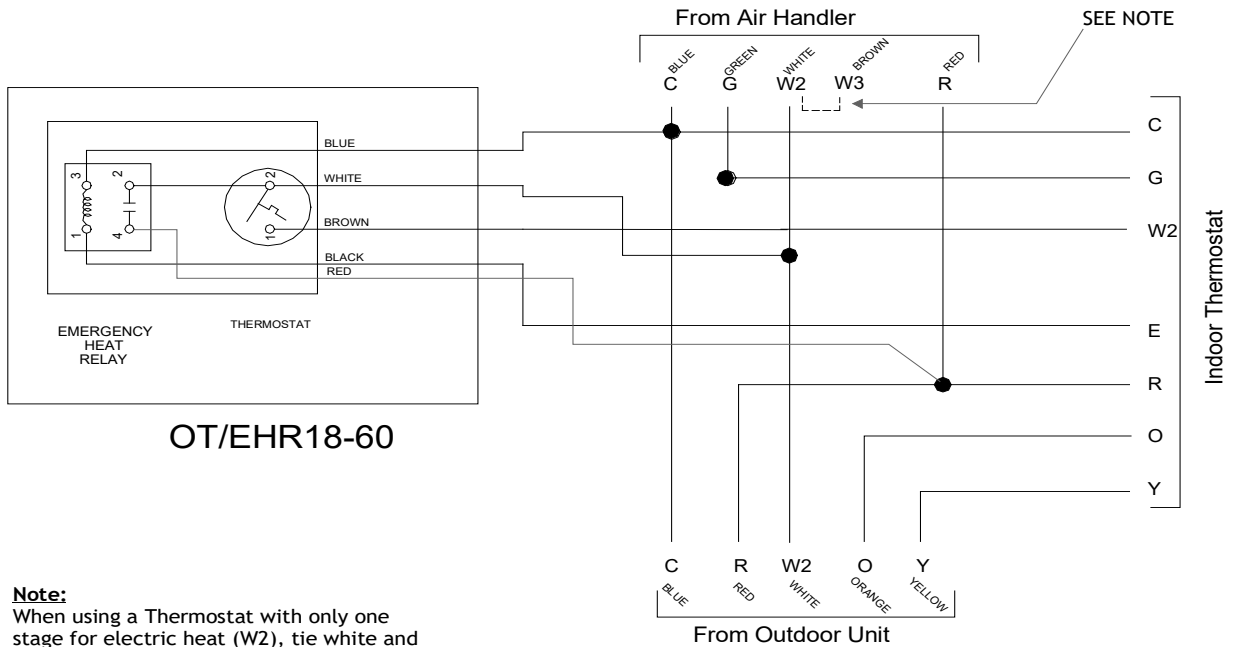

Note:
When using a Thermostat with only one stage for electric heat (W2), tie white and brown wires from air handler together.

Typical Wiring Schematics for OT/EHR18-60 (Outdoor Thermostat & Emergency Heat Relay).
This wiring diagram is for reference only. Not all wiring is as shown above.
Refer to the appropriate wiring diagram for the unit being serviced.

Wiring is subject to change. Always refer to the wiring diagram on the unit for the most up-to-date wiring.



WARNING

HIGH VOLTAGE!
DISCONNECT ALL POWER BEFORE SERVICING OR INSTALLING THIS UNIT.
MULTIPLE POWER SOURCES MAY BE PRESENT. FAILURE TO DO SO MAY
CAUSE PROPERTY DAMAGE, PERSONAL INJURY OR DEATH.

WIRING DIAGRAMS

15kw and Above with Two OT/EHR18-60's, Two Stage Electric Heat and Two Stage Thermostat

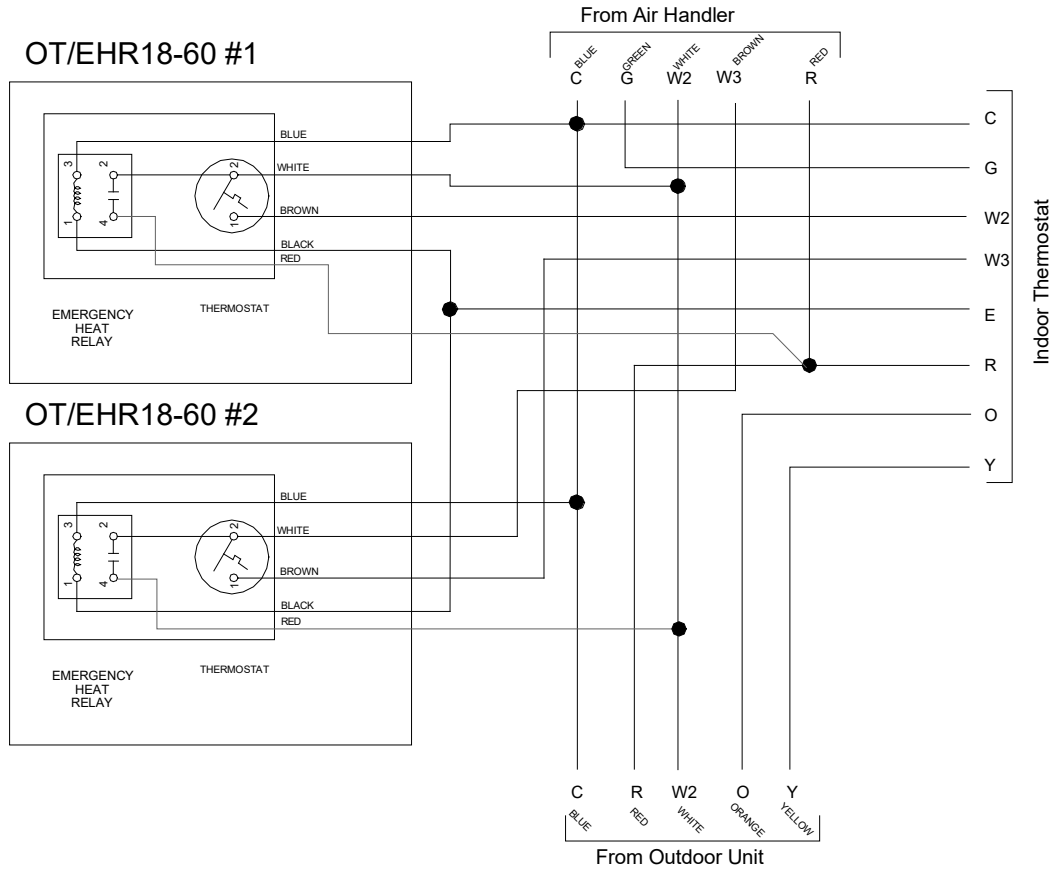

Typical Wiring Schematics for OT/EHR18-60 (Outdoor Thermostat & Emergency Heat Relay).
 This wiring diagram is for reference only. Not all wiring is as shown above.
 Refer to the appropriate wiring diagram for the unit being serviced.



HIGH VOLTAGE!
 DISCONNECT ALL POWER BEFORE SERVICING OR INSTALLING THIS UNIT.
 MULTIPLE POWER SOURCES MAY BE PRESENT. FAILURE TO DO SO MAY
 CAUSE PROPERTY DAMAGE, PERSONAL INJURY OR DEATH.

WARNING



Wiring is subject to change. Always refer to the wiring diagram on the unit for the most up-to-date wiring.

WIRING DIAGRAMS

3-Phase Heat Kit

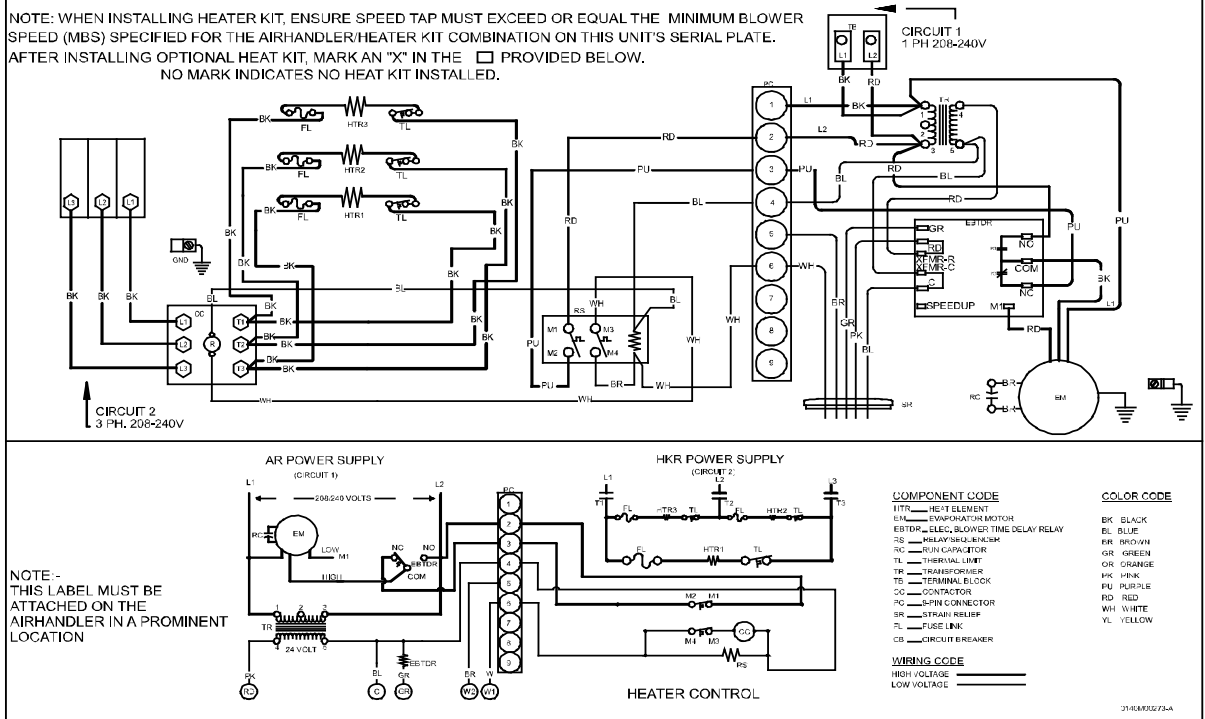

25kW Heat Kit

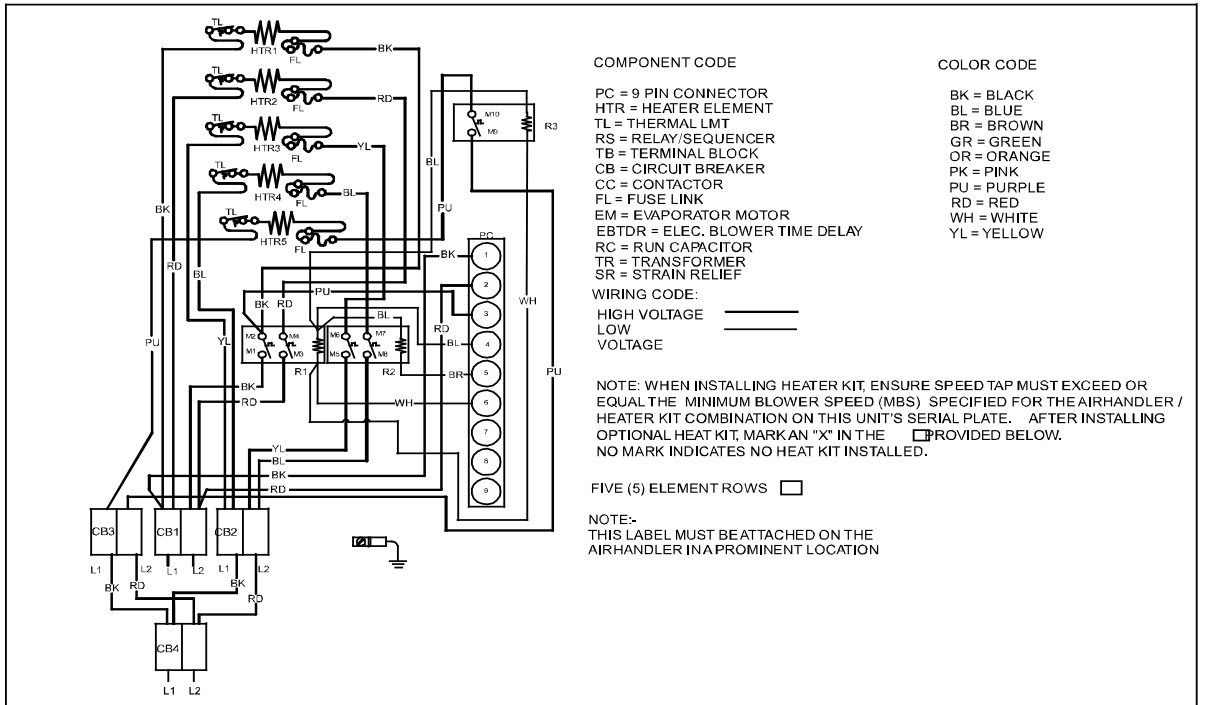

WARNING

DISCONNECT ALL POWER BEFORE SERVICING OR INSTALLING THIS UNIT. MULTIPLE POWER SOURCES MAY BE PRESENT. FAILURE TO DO SO MAY CAUSE PROPERTY DAMAGE, PERSONAL INJURY OR DEATH.

HIGH VOLTAGE!
DISCONNECT ALL POWER BEFORE SERVICING OR INSTALLING THIS UNIT.
MULTIPLE POWER SOURCES MAY BE PRESENT. FAILURE TO DO SO MAY
CAUSE PROPERTY DAMAGE, PERSONAL INJURY OR DEATH.

WARNING

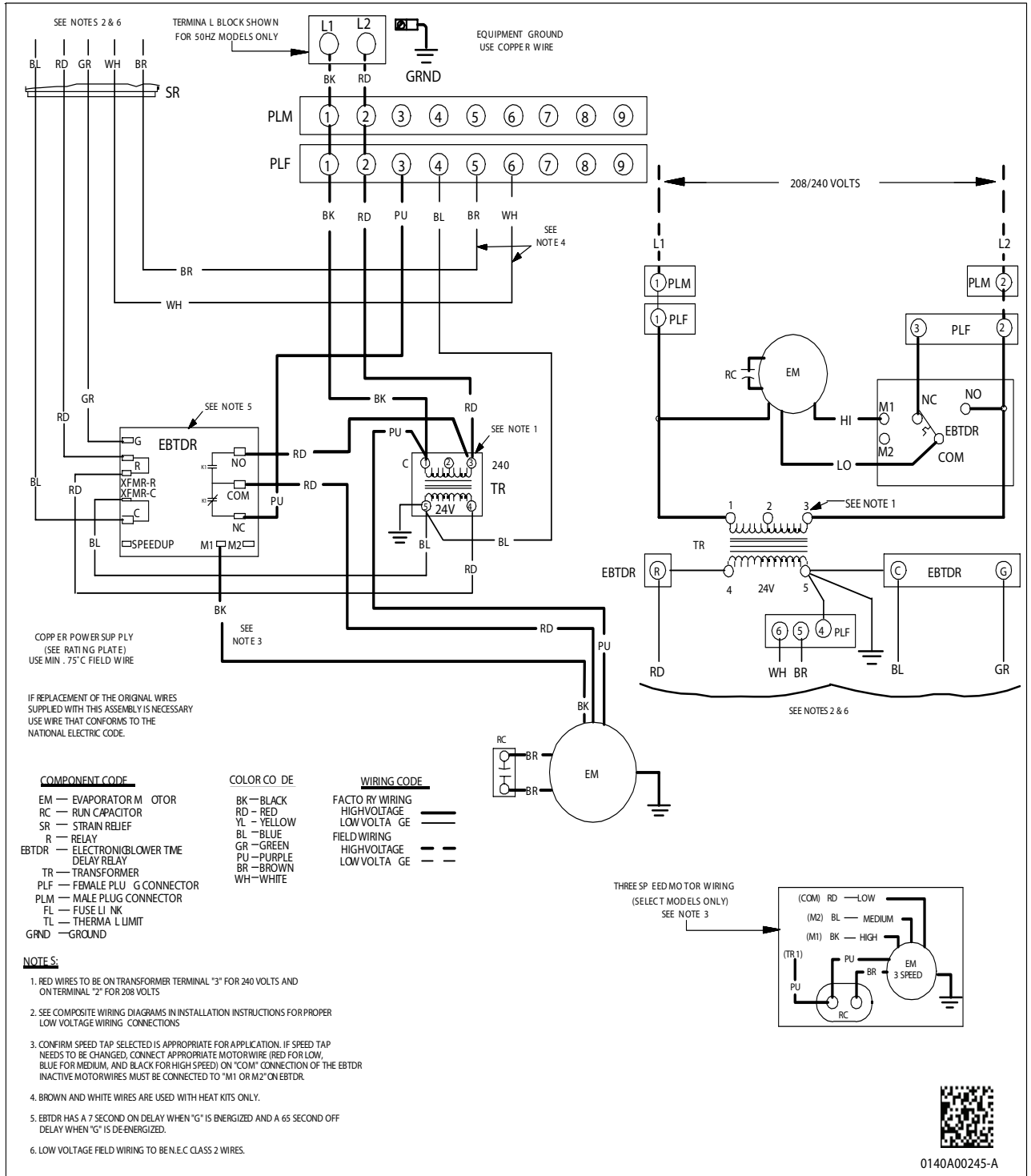

0140A00245-A

HIGH VOLTAGE!
 DISCONNECT ALL POWER BEFORE SERVICING OR INSTALLING THIS UNIT.
 MULTIPLE POWER SOURCES MAY BE PRESENT. FAILURE TO DO SO MAY
 CAUSE PROPERTY DAMAGE, PERSONAL INJURY OR DEATH.
WARNING

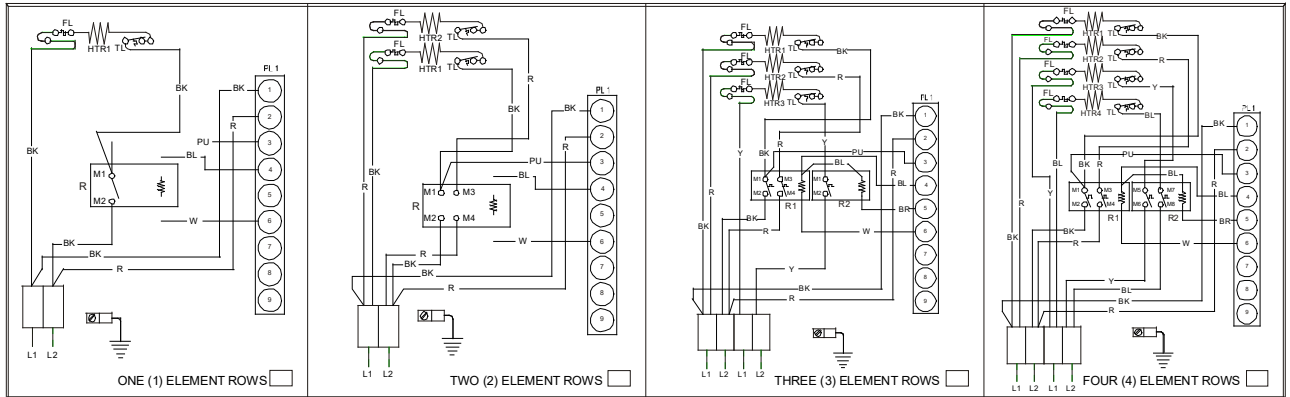

AFTER INSTALLING OPTIONAL HEAT KIT, MARK AN "X" IN THE PROVIDED ABOVE.
 MARK ACCORDING TO NUMBER OF HEATER ELEMENT ROWS INSTALLED
 NO MARK INDICATES NO HEAT KIT INSTALLED

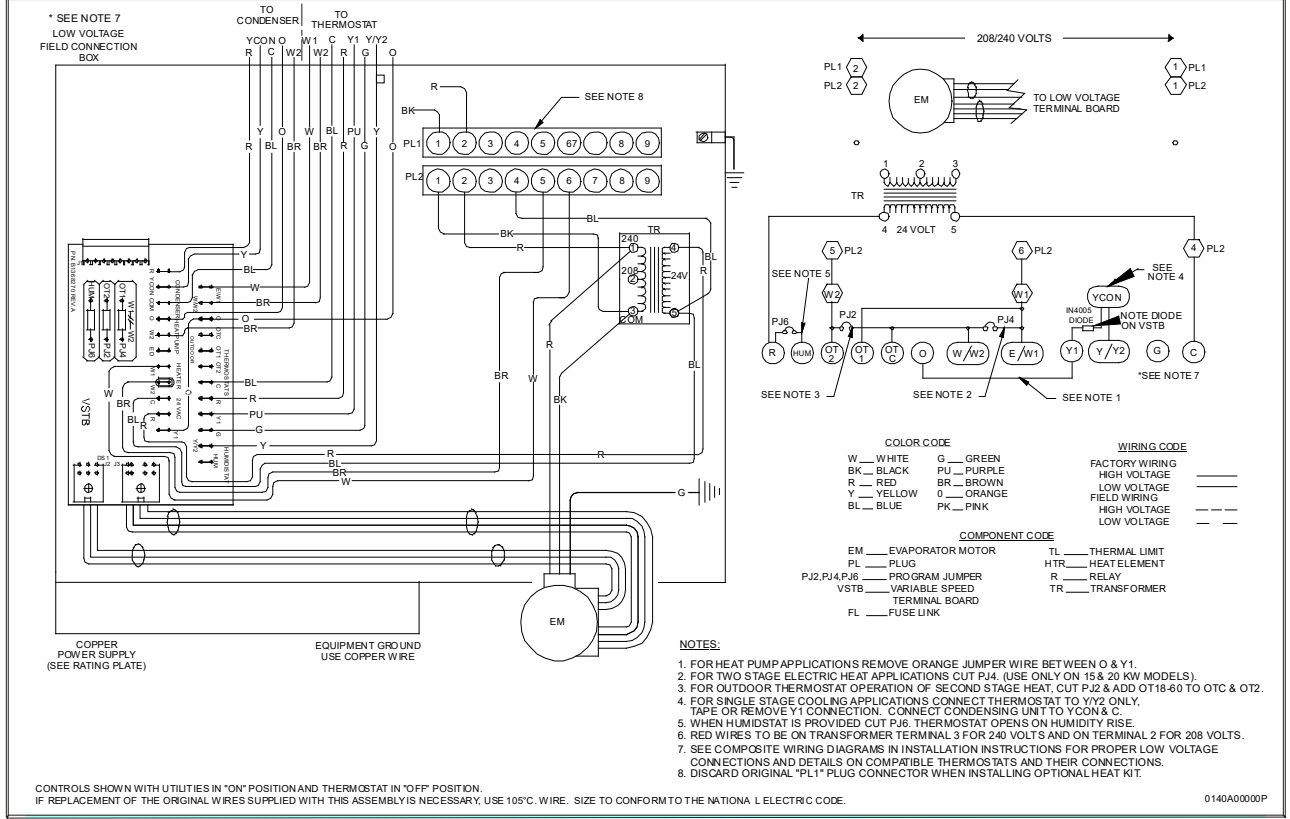

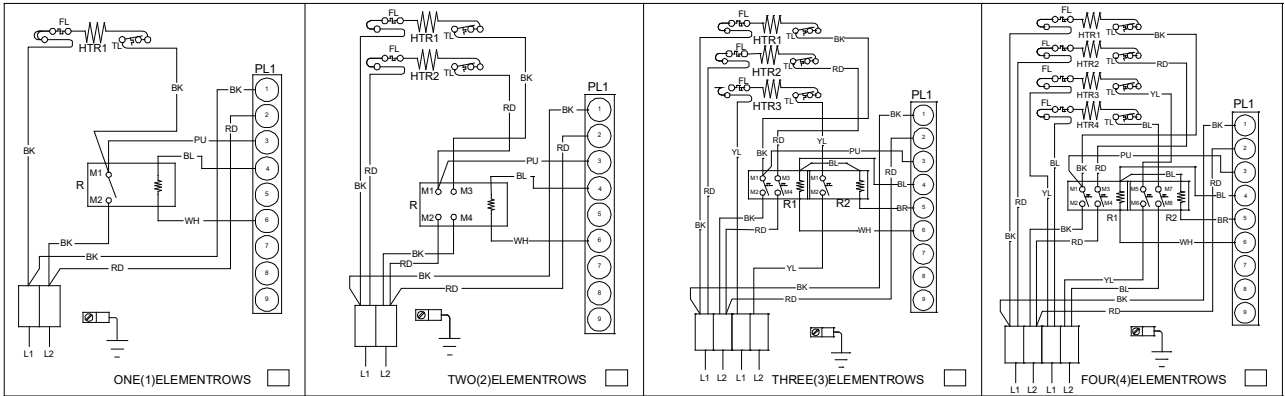



AFTER INSTALLING OPTIONAL HEAT KIT, MARK "X" IN THE PROVIDED ABOVE.
 MARK ACCORDING TO NUMBER OF HEATER ELEMENT ROWS INSTALLED.
NO MARK INDICATES NO HEAT KIT INSTALLED

HIGH VOLTAGE!
 DISCONNECT ALL POWER BEFORE SERVICING OR INSTALLING THIS UNIT.
 MULTIPLE POWER SOURCES MAY BE PRESENT. FAILURE TO DO SO MAY
 CAUSE PROPERTY DAMAGE, PERSONAL INJURY OR DEATH.

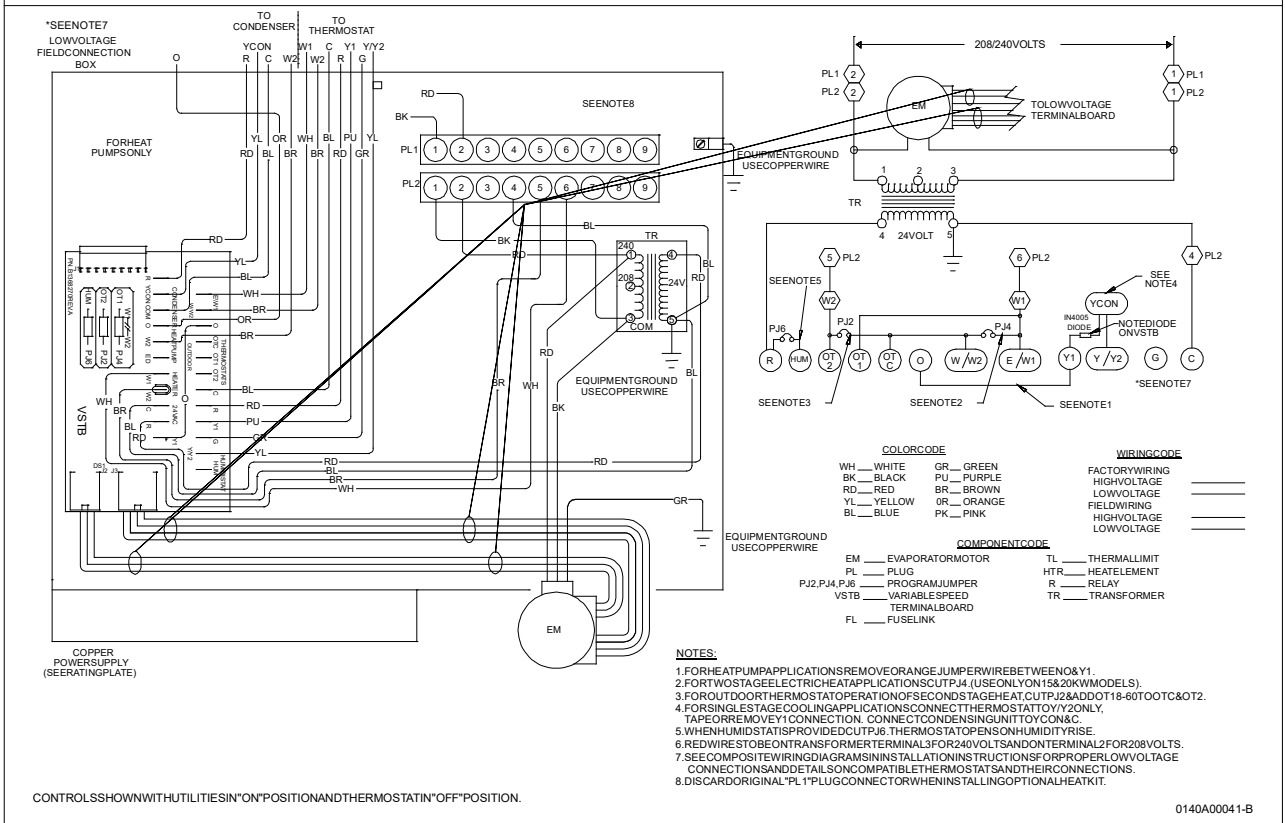
WARNING





WARNING

HIGH VOLTAGE!
DISCONNECT ALL POWER BEFORE SERVICING OR INSTALLING THIS UNIT.
MULTIPLE POWER SOURCES MAY BE PRESENT. FAILURE TO DO SO MAY
CAUSE PROPERTY DAMAGE, PERSONAL INJURY OR DEATH.

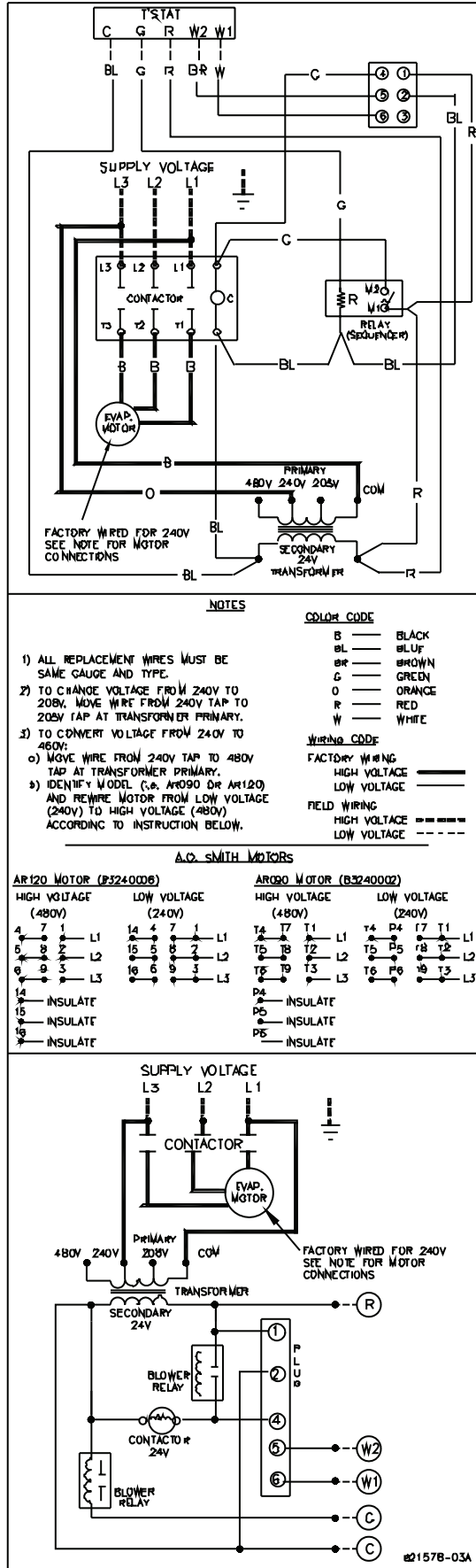

Wiring is subject to change. Always refer to the wiring diagram on the unit for the most up-to-date wiring.



WARNING

HIGH VOLTAGE!

DISCONNECT ALL POWER BEFORE SERVICING OR INSTALLING THIS UNIT.
MULTIPLE POWER SOURCES MAY BE PRESENT. FAILURE TO DO SO MAY
CAUSE PROPERTY DAMAGE, PERSONAL INJURY OR DEATH.

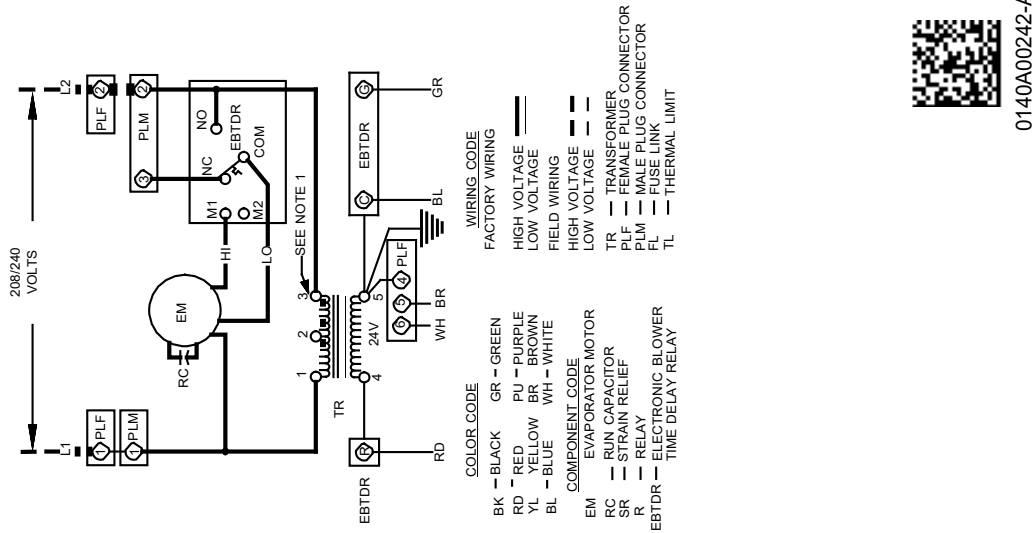



WARNING

HIGH VOLTAGE!
 DISCONNECT ALL POWER BEFORE SERVICING OR INSTALLING THIS UNIT.
 MULTIPLE POWER SOURCES MAY BE PRESENT. FAILURE TO DO SO MAY
 CAUSE PROPERTY DAMAGE, PERSONAL INJURY OR DEATH.

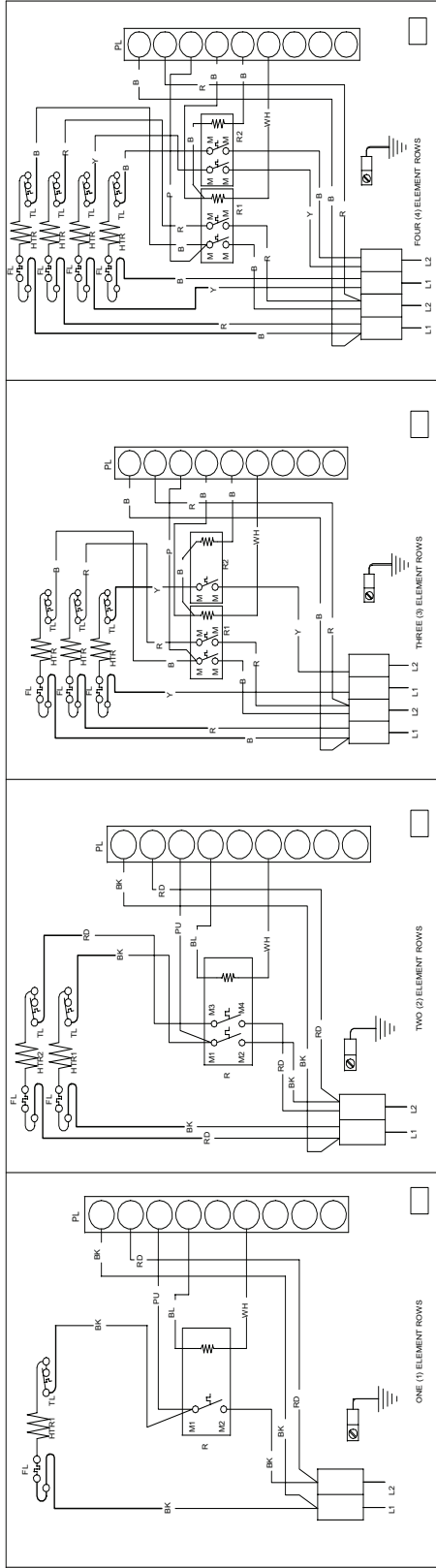

NOTE: WHEN INSTALLING HEATER KIT, ENSURE SPEED TAP DOES NOT EXCEED MINIMUM LOWER SPEED (MBS) SPECIFIED FOR THE ARMATURE/HEAT KIT COMBINATION ON THIS UNIT'S S&M PLATE. AT TER INSTALLING OPTIONAL HEAT KIT, MARK "X" IN THE PROVIDED ABOVE. MARK ACCORDING TO NUMBER OF HEATER ELEMENT ROWS INSTALLED. NO MARK INDICATES NO HEAT KIT INSTALLED. EQUIPMENT GROUND USE COPPER WIRE

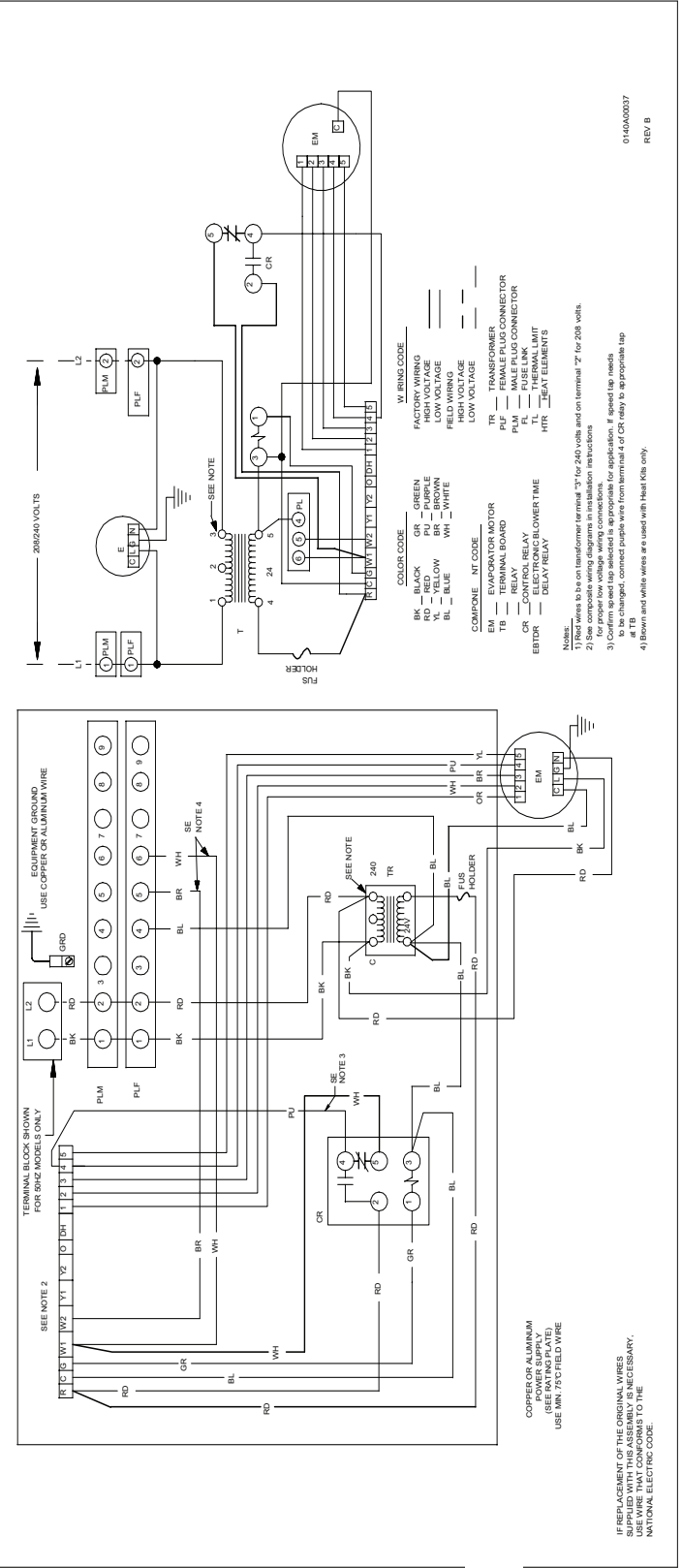

COPPER OR ALUMINUM (SEE RATING PLATE) USE MIN. 75°C FIELD WIRE

0140A00037 REV B

WARNING

HIGH VOLTAGE!
 DISCONNECT ALL POWER BEFORE SERVICING OR INSTALLING THIS UNIT.
 MULTIPLE POWER SOURCES MAY BE PRESENT. FAILURE TO DO SO MAY
 CAUSE PROPERTY DAMAGE, PERSONAL INJURY OR DEATH.

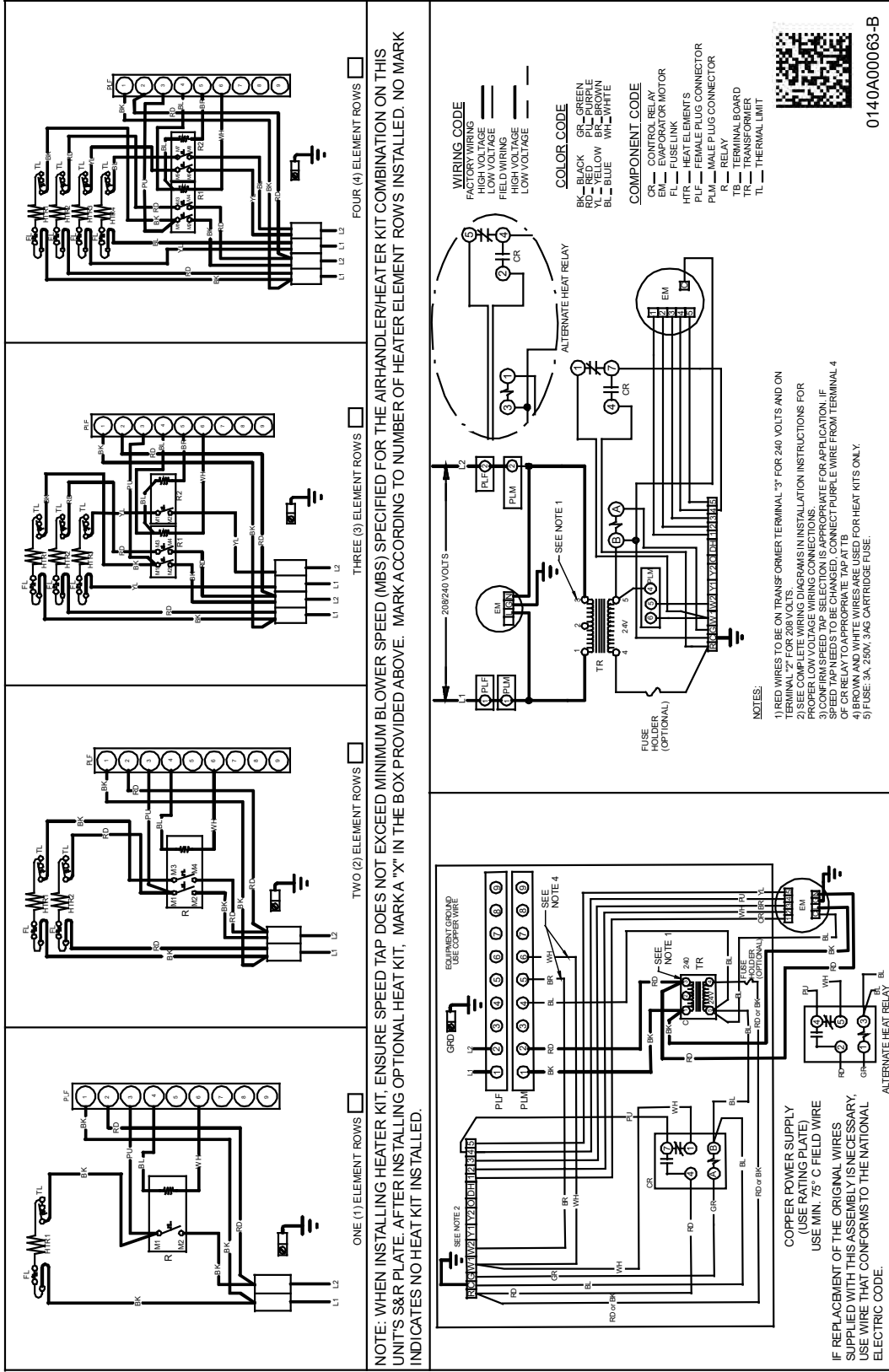

0140A00063-B

Wiring is subject to change. Always refer to the wiring diagram on the unit for the most up-to-date wiring.



WARNING

HIGH VOLTAGE!
 DISCONNECT ALL POWER BEFORE SERVICING OR INSTALLING THIS UNIT.
 MULTIPLE POWER SOURCES MAY BE PRESENT. FAILURE TO DO SO MAY
 CAUSE PROPERTY DAMAGE, PERSONAL INJURY OR DEATH.

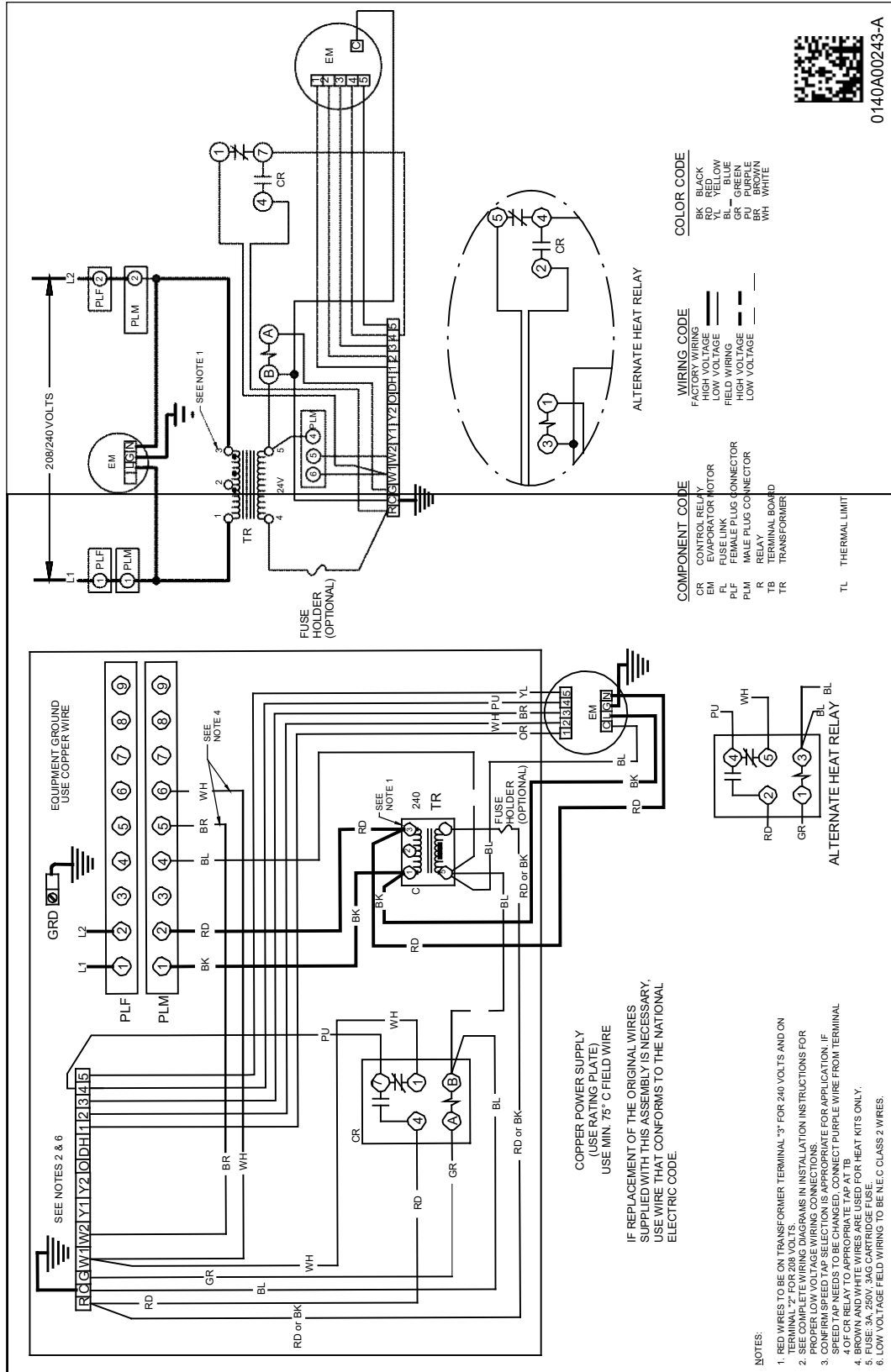

0140A00243-A

WIRING DIAGRAMS

3-PHASE HEAT KIT

ASPT**14**/ASUF**14**



WARNING

HIGH VOLTAGE!
 DISCONNECT ALL POWER BEFORE SERVICING OR INSTALLING THIS UNIT.
 MULTIPLE POWER SOURCES MAY BE PRESENT. FAILURE TO DO SO MAY
 CAUSE PROPERTY DAMAGE, PERSONAL INJURY OR DEATH.

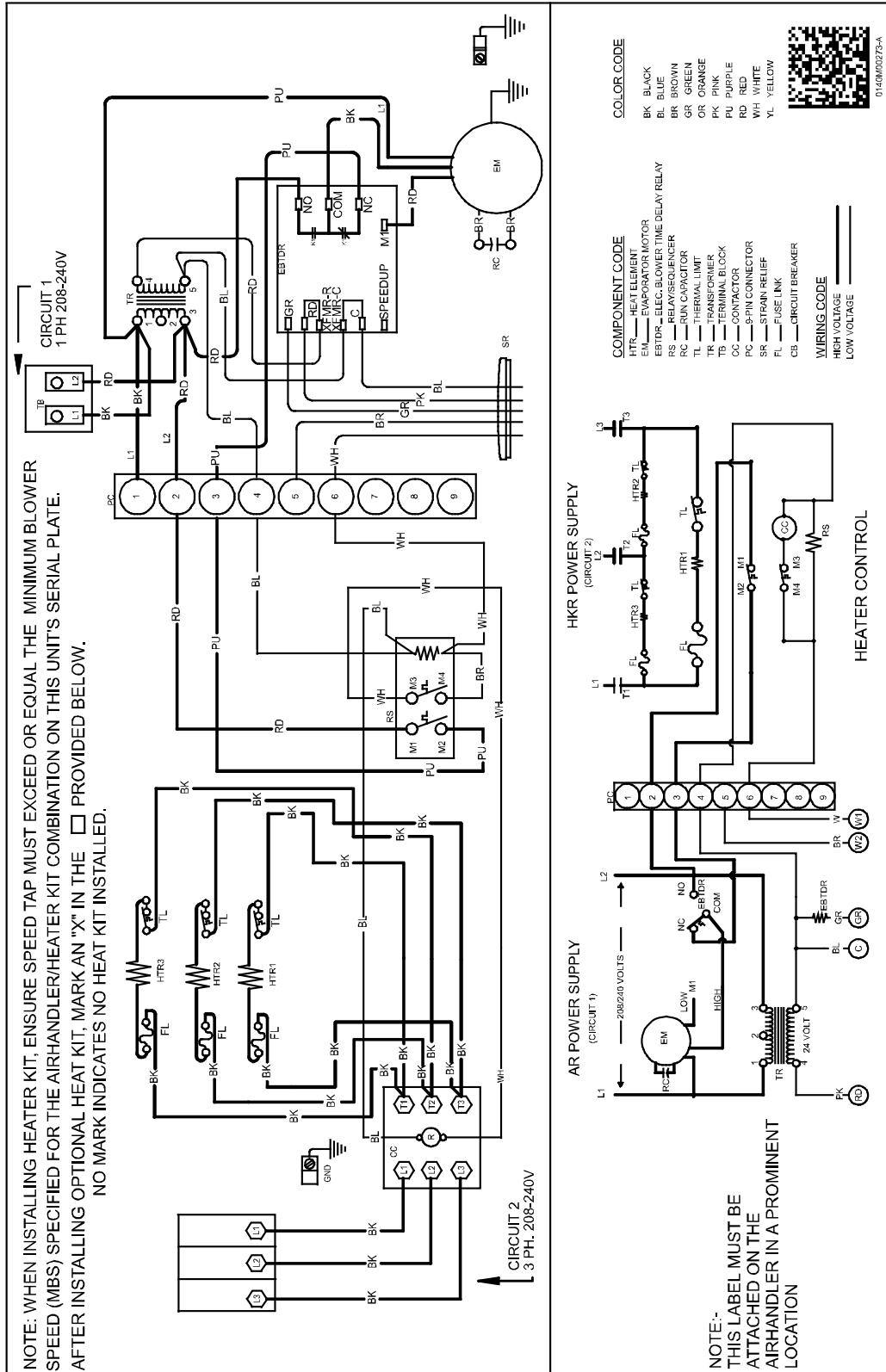



NOTE: THIS LABEL MUST BE ATTACHED ON THE AIRHANDLER IN A PROMINENT LOCATION

Wiring is subject to change. Always refer to the wiring diagram on the unit for the most up-to-date wiring.

HIGH VOLTAGE!
 DISCONNECT ALL POWER BEFORE SERVICING OR INSTALLING THIS UNIT.
 MULTIPLE POWER SOURCES MAY BE PRESENT. FAILURE TO DO SO MAY
 CAUSE PROPERTY DAMAGE, PERSONAL INJURY OR DEATH.

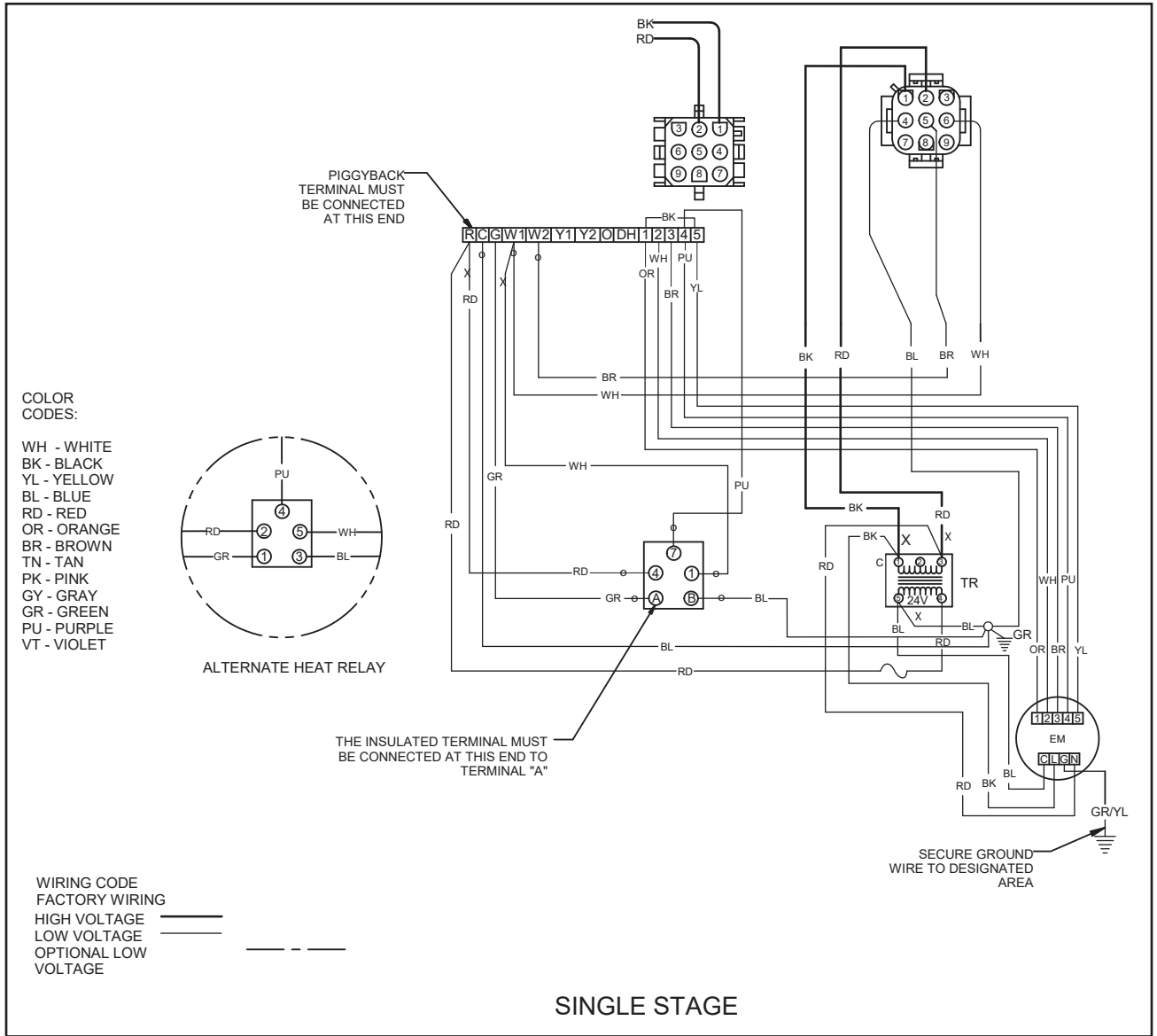
WARNING





WARNING

HIGH VOLTAGE!

DISCONNECT ALL POWER BEFORE SERVICING OR INSTALLING THIS UNIT.
MULTIPLE POWER SOURCES MAY BE PRESENT. FAILURE TO DO SO MAY
CAUSE PROPERTY DAMAGE, PERSONAL INJURY OR DEATH.



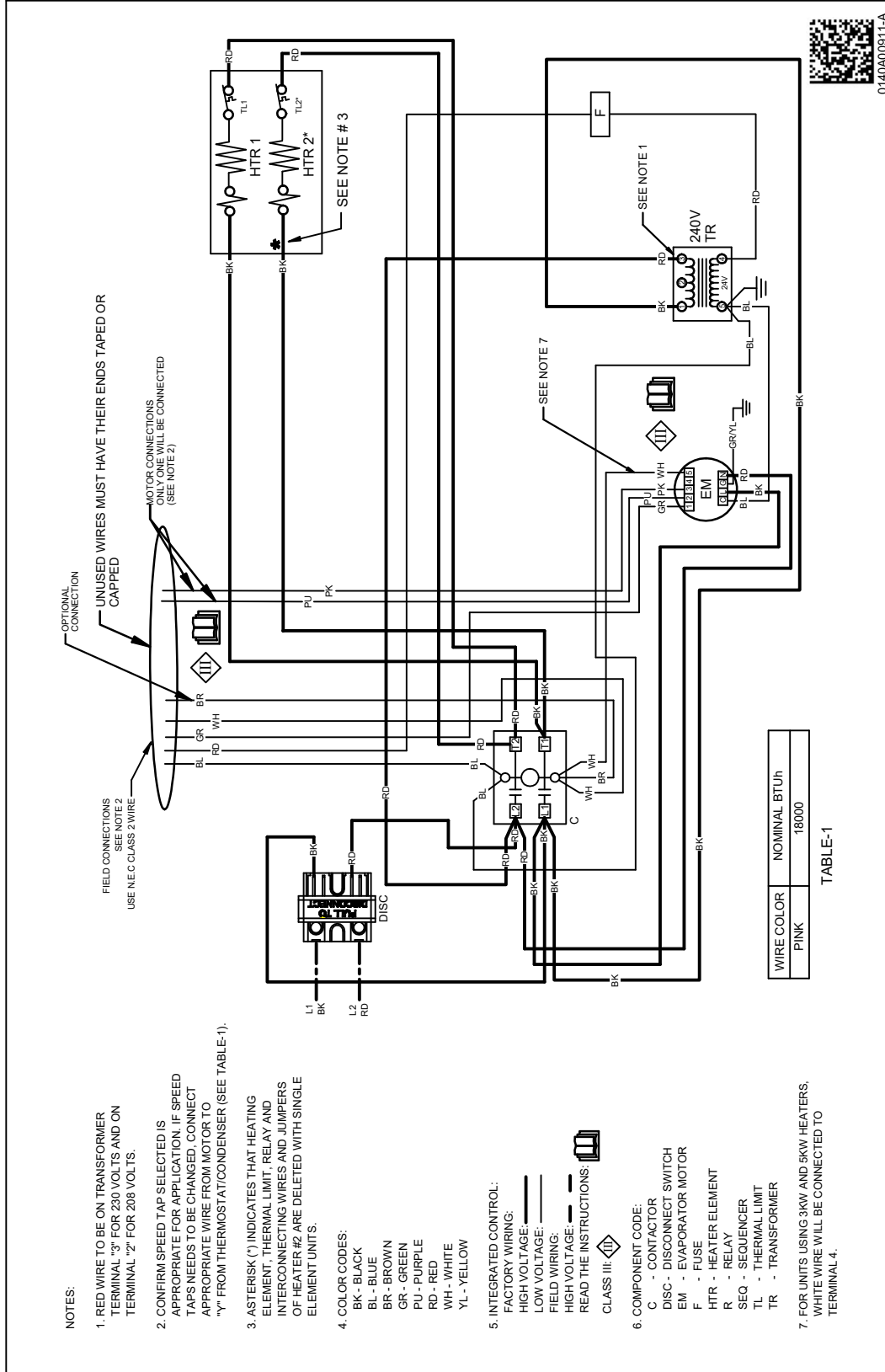

Wiring is subject to change. Always refer to the wiring diagram on the unit for the most up-to-date wiring.



WARNING

HIGH VOLTAGE!

DISCONNECT ALL POWER BEFORE SERVICING OR INSTALLING THIS UNIT.
MULTIPLE POWER SOURCES MAY BE PRESENT. FAILURE TO DO SO MAY
CAUSE PROPERTY DAMAGE, PERSONAL INJURY OR DEATH.



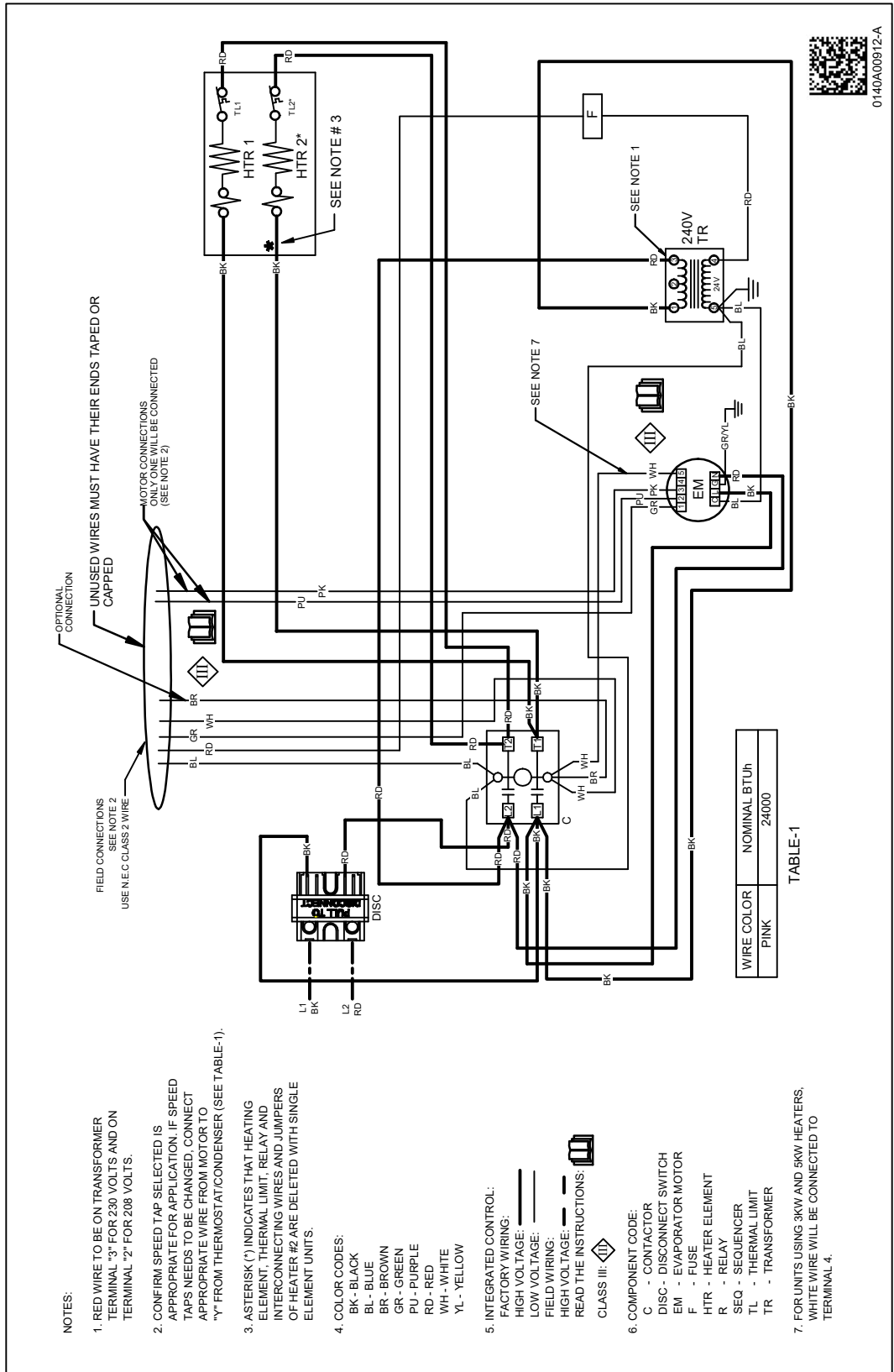

Wiring is subject to change. Always refer to the wiring diagram on the unit for the most up-to-date wiring.



WARNING

HIGH VOLTAGE!

DISCONNECT ALL POWER BEFORE SERVICING OR INSTALLING THIS UNIT.
MULTIPLE POWER SOURCES MAY BE PRESENT. FAILURE TO DO SO MAY
CAUSE PROPERTY DAMAGE, PERSONAL INJURY OR DEATH.

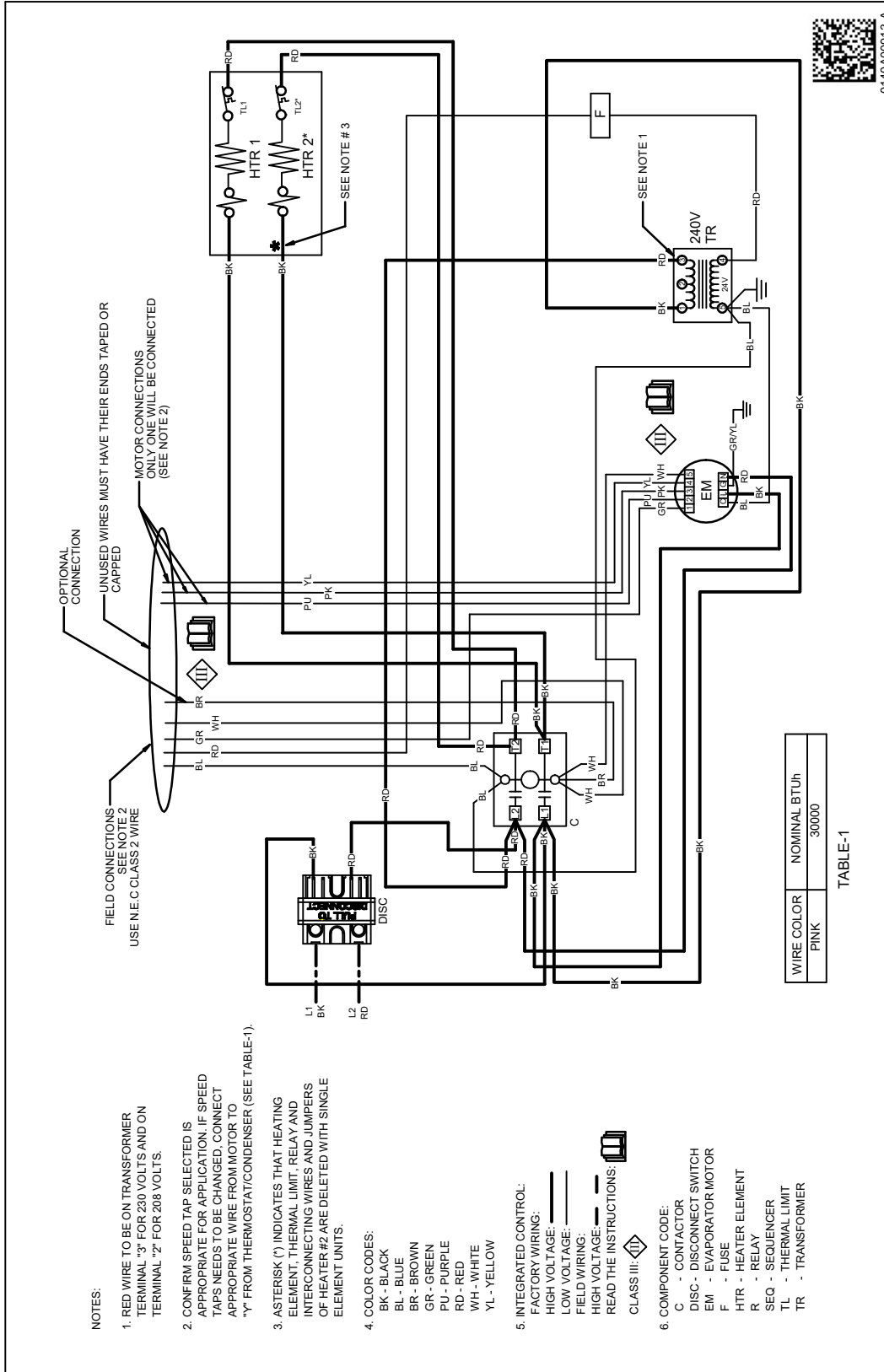

Wiring is subject to change. Always refer to the wiring diagram on the unit for the most up-to-date wiring.



WARNING

HIGH VOLTAGE!

DISCONNECT ALL POWER BEFORE SERVICING OR INSTALLING THIS UNIT. MULTIPLE POWER SOURCES MAY BE PRESENT. FAILURE TO DO SO MAY CAUSE PROPERTY DAMAGE, PERSONAL INJURY OR DEATH.

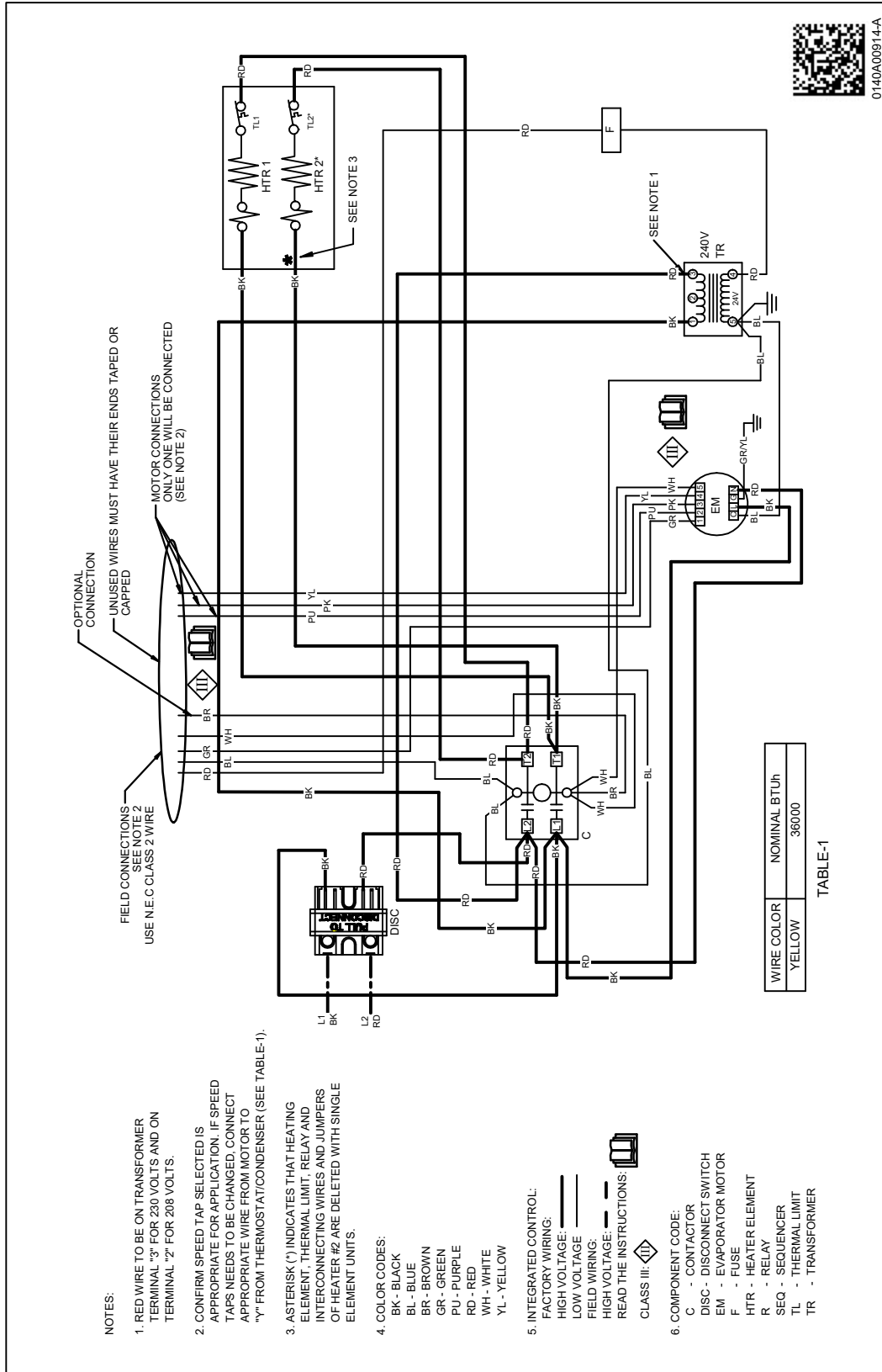

0140A0091.4-A



WARNING

HIGH VOLTAGE!

DISCONNECT ALL POWER BEFORE SERVICING OR INSTALLING THIS UNIT. MULTIPLE POWER SOURCES MAY BE PRESENT. FAILURE TO DO SO MAY CAUSE PROPERTY DAMAGE, PERSONAL INJURY OR DEATH.

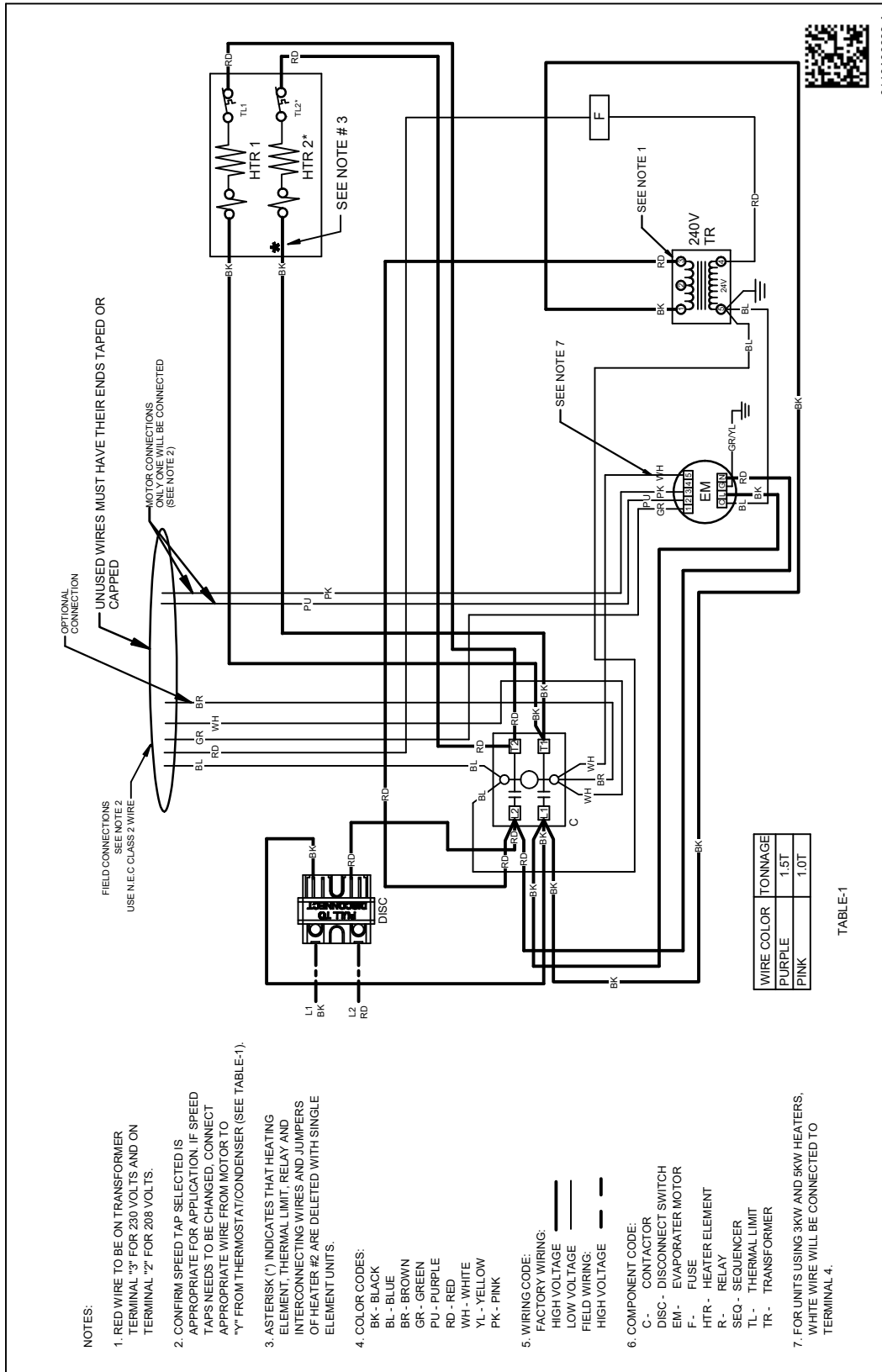

0140A00698-A





WARNING

HIGH VOLTAGE!

DISCONNECT ALL POWER BEFORE SERVICING OR INSTALLING THIS UNIT.
MULTIPLE POWER SOURCES MAY BE PRESENT. FAILURE TO DO SO MAY
CAUSE PROPERTY DAMAGE, PERSONAL INJURY OR DEATH.



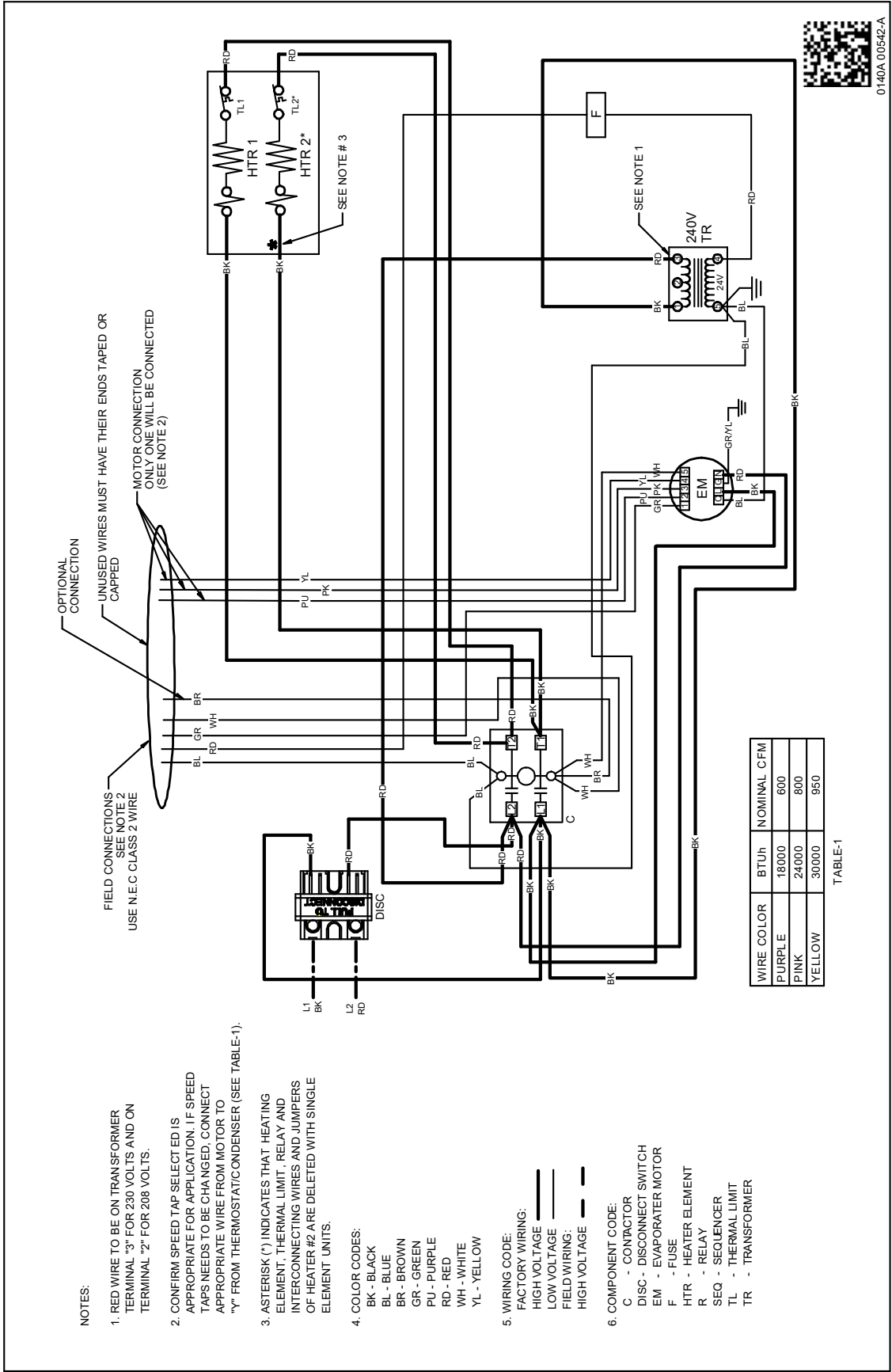

Wiring is subject to change. Always refer to the wiring diagram on the unit for the most up-to-date wiring.



WARNING

HIGH VOLTAGE!

DISCONNECT ALL POWER BEFORE SERVICING OR INSTALLING THIS UNIT. MULTIPLE POWER SOURCES MAY BE PRESENT. FAILURE TO DO SO MAY CAUSE PROPERTY DAMAGE, PERSONAL INJURY OR DEATH.

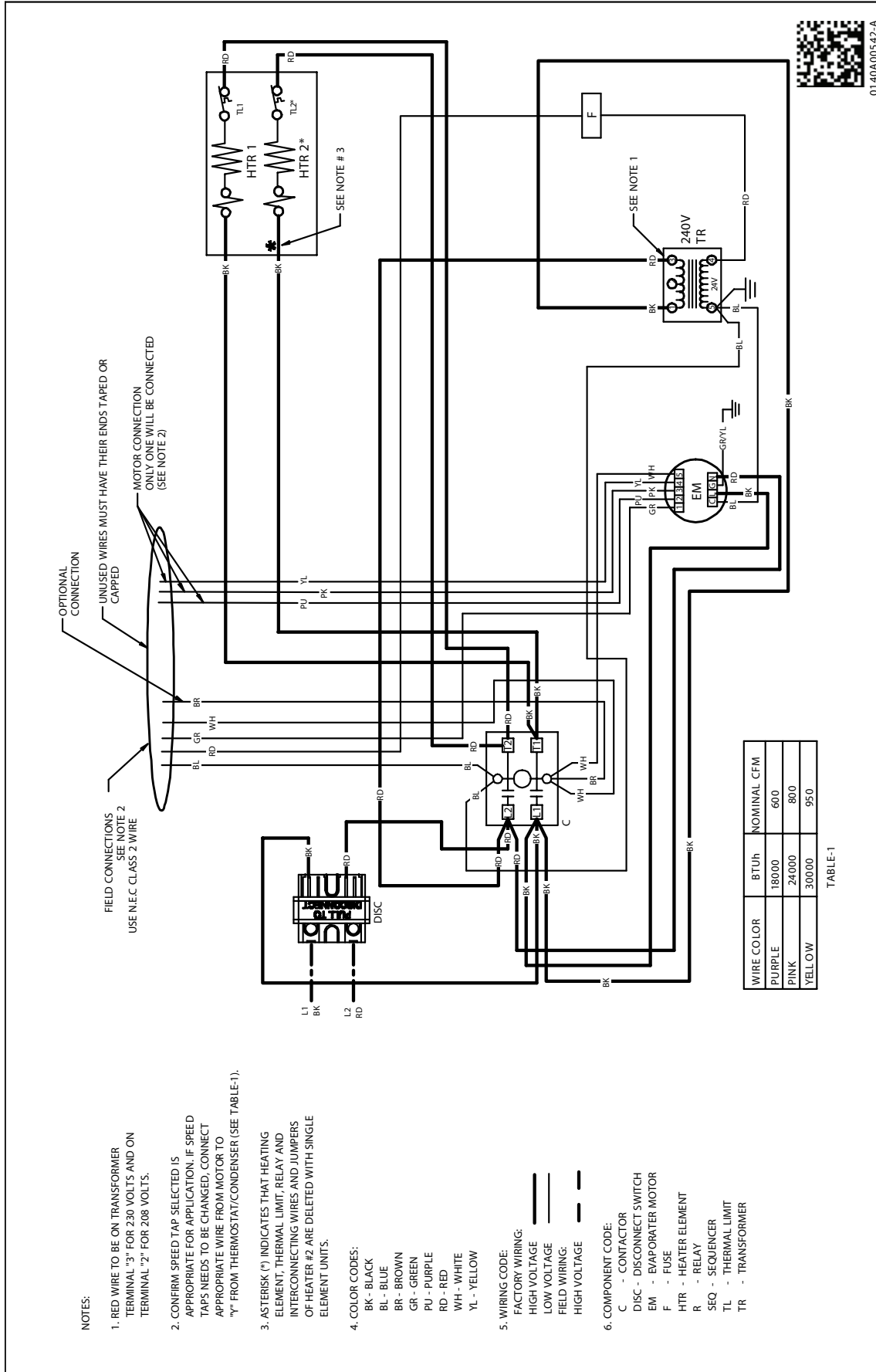

NOTES:

1. RED WIRE TO BE ON TRANSFORMER TERMINAL "3" FOR 230 VOLTS AND ON TERMINAL "2" FOR 208 VOLTS.
2. CONFIRM SPEED TAP SELECTED IS APPROPRIATE FOR APPLICATION. IF SPEED TAPS NEEDS TO BE CHANGED, CONNECT APPROPRIATE WIRE FROM MOTOR TO "Y" FROM THERMOSTAT/CONDENSER (SEE TABLE-1).
3. ASTERISK (*) INDICATES THAT HEATING ELEMENT, THERMAL LIMIT, RELAY AND INTERCONNECTING WIRES AND JUMPERS OF HEATER #2 ARE DELETED WITH SINGLE ELEMENT UNITS.
4. COLOR CODES:
BK - BLACK
BL - BLUE
BR - BROWN
GR - GREEN
PU - PURPLE
RD - RED
WH - WHITE
YL - YELLOW
5. WIRING CODE:
FACTORY WIRING: ———
HIGH VOLTAGE ———
LOW VOLTAGE ———
FIELD WIRING: - - -
HIGH VOLTAGE - - -
6. COMPONENT CODE:
C - CONTACTOR
DISC - DISCONNECT SWITCH
EM - EVAPORATOR MOTOR
F - FUSE
HTR - HEATER ELEMENT
R - RELAY
SEQ - SEQUENCER
TL - THERMAL LIMIT
TR - TRANSFORMER

FIELD CONNECTIONS SEE NOTE 2
USE N.E.C. CLASS 2 WIRE

OPTIONAL CONNECTION

UNUSED WIRES MUST HAVE THEIR ENDS TAPED OR CAPPED

MOTOR CONNECTION ONLY ONE WILL BE CONNECTED (SEE NOTE 2)

TABLE-1

WIRE COLOR	BTUH	NOMINAL CFM
PURPLE	18000	600
PINK	24000	800
YELLOW	30000	950

WIRING DIAGRAMS

AWUF180[316,516,816]BD, AWUF240[316,516,816]BD,
 AWUF241016BD,AWUF300[516,816]BE,
 AWUF301016BE, AWUF360[516,816]BE,
 AWUF361016BE, AWUT24[05,08,10]14AA



WARNING

HIGH VOLTAGE!
 DISCONNECT ALL POWER BEFORE SERVICING OR INSTALLING THIS UNIT.
 MULTIPLE POWER SOURCES MAY BE PRESENT. FAILURE TO DO SO MAY
 CAUSE PROPERTY DAMAGE, PERSONAL INJURY OR DEATH.

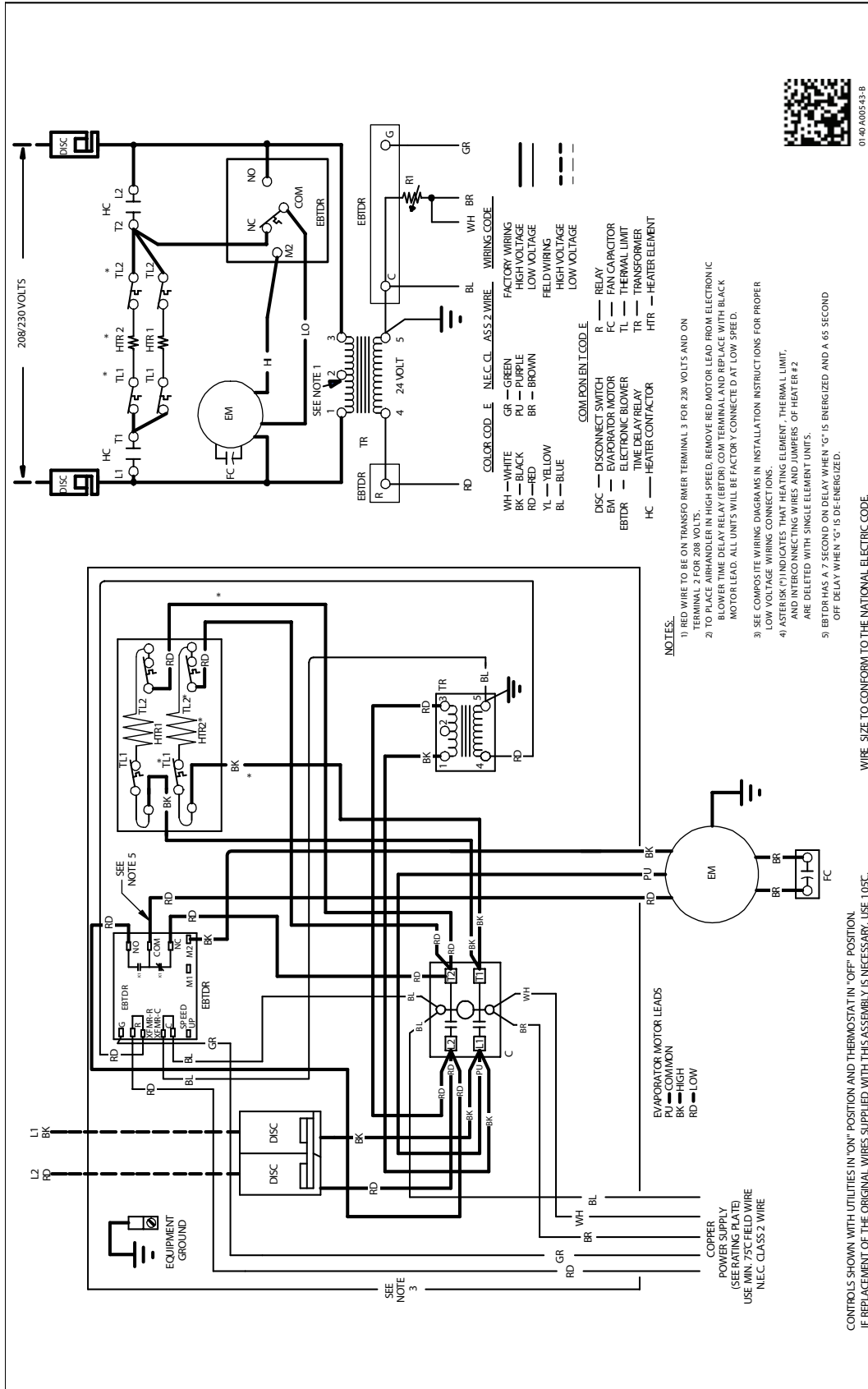

01-40-A005-8-B

Wiring is subject to change. Always refer to the wiring diagram on the unit for the most up-to-date wiring.



WARNING

HIGH VOLTAGE!

DISCONNECT ALL POWER BEFORE SERVICING OR INSTALLING THIS UNIT. MULTIPLE POWER SOURCES MAY BE PRESENT. FAILURE TO DO SO MAY CAUSE PROPERTY DAMAGE, PERSONAL INJURY OR DEATH.

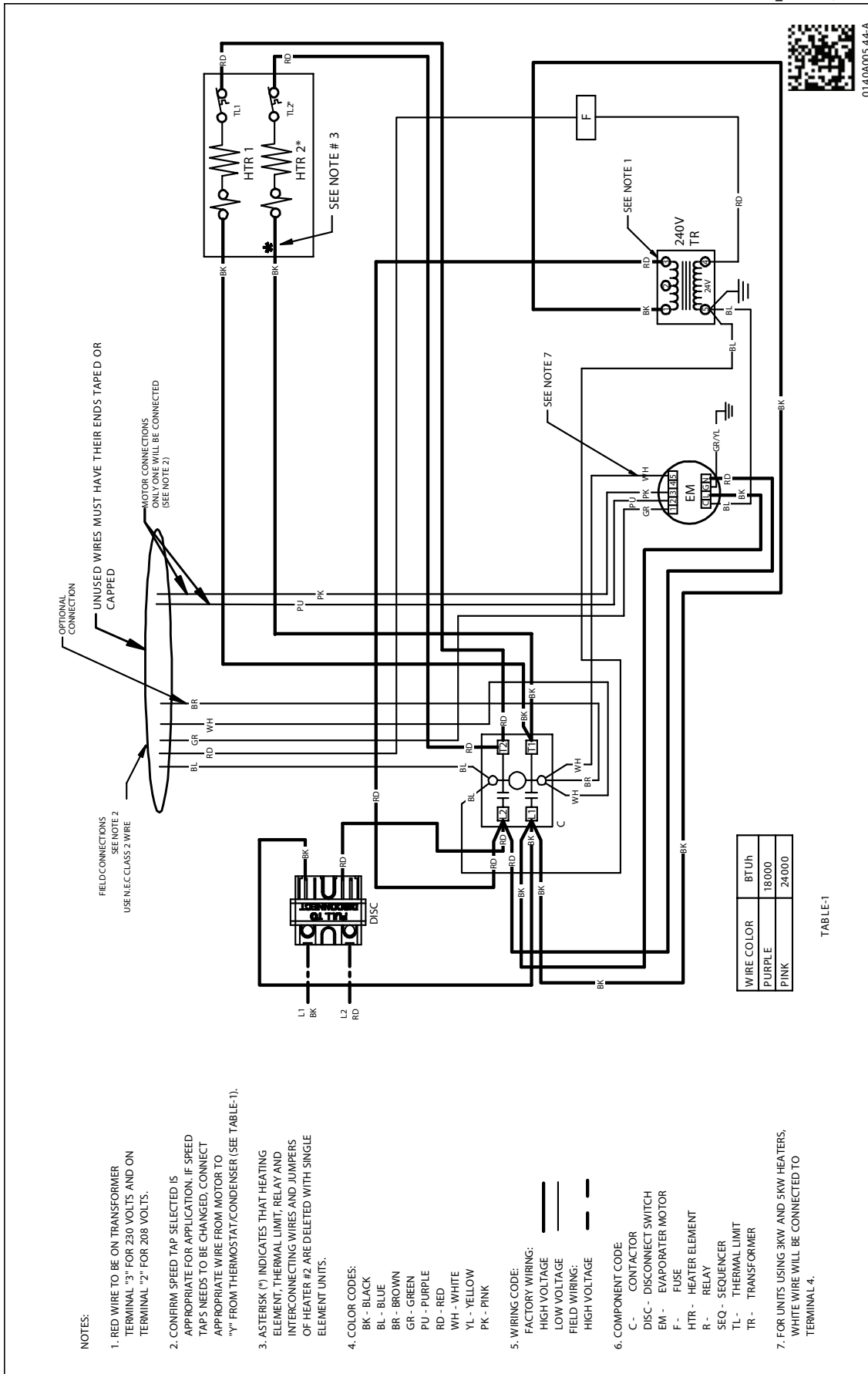

Wiring is subject to change. Always refer to the wiring diagram on the unit for the most up-to-date wiring.



WARNING

HIGH VOLTAGE!

DISCONNECT ALL POWER BEFORE SERVICING OR INSTALLING THIS UNIT.
MULTIPLE POWER SOURCES MAY BE PRESENT. FAILURE TO DO SO MAY
CAUSE PROPERTY DAMAGE, PERSONAL INJURY OR DEATH.

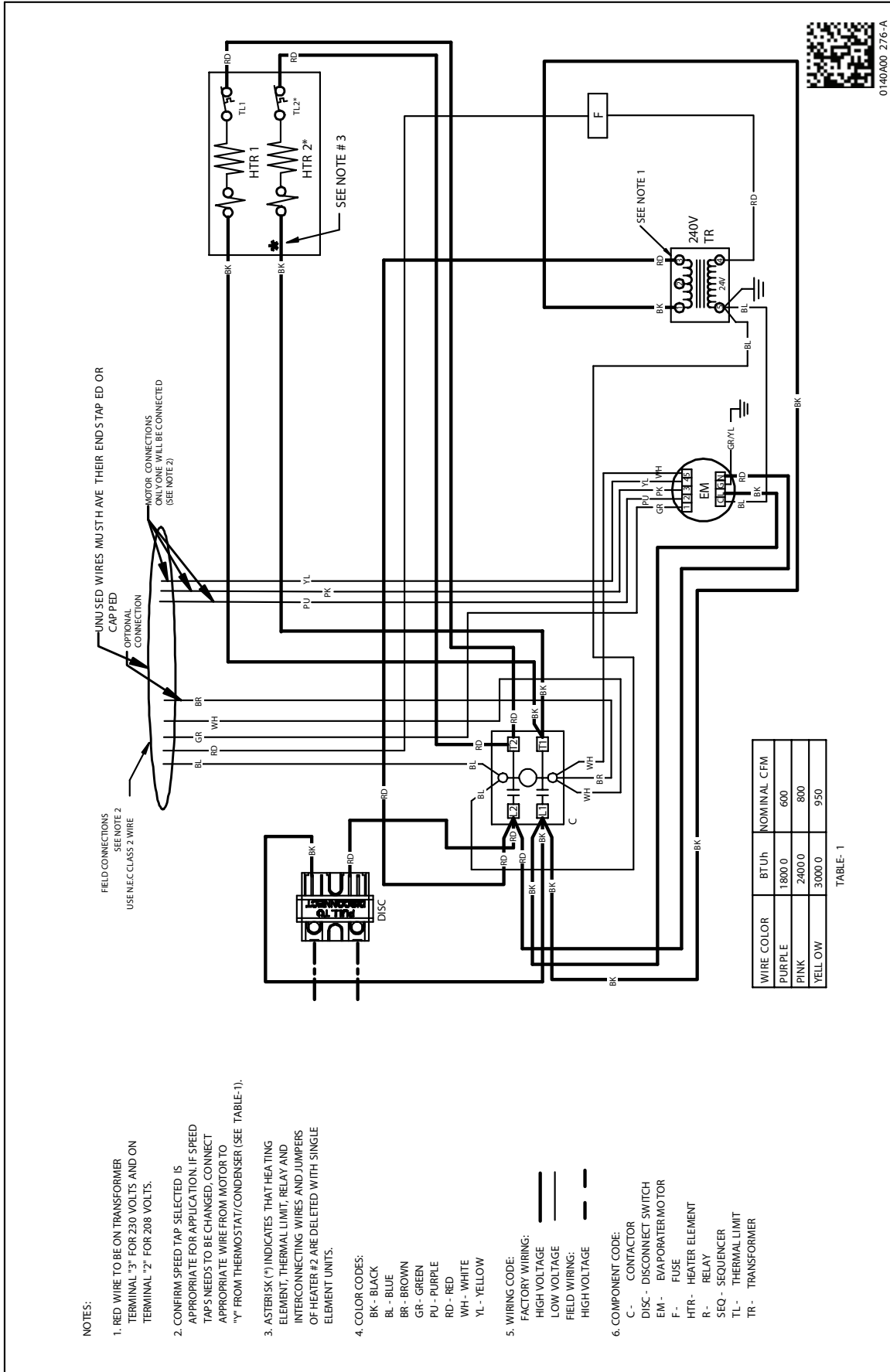

- NOTES:
- RED WIRE TO BE ON TRANSFORMER TERMINAL "3" FOR 230 VOLTS AND ON TERMINAL "2" FOR 208 VOLTS.
 - CONFIRM SPEED TAP SELECTED IS APPROPRIATE FOR APPLICATION. IF SPEED TAP'S NEEDS TO BE CHANGED, CONNECT APPROPRIATE WIRE FROM MOTOR TO "Y" FROM THERMOSTAT/CONDENSER (SEE TABLE-1).
 - ASTERISK (*) INDICATES THAT HEATING ELEMENT, THERMAL LIMIT, RELAY AND INTERCONNECTING WIRES AND JUMPERS OF HEATER #2 ARE DELETED WITH SINGLE ELEMENT UNITS.
 - COLOR CODES:
BK - BLACK
BL - BLUE
BR - BROWN
GR - GREEN
PU - PURPLE
RD - RED
WH - WHITE
YL - YELLOW
 - WIRING CODE:
FACTORY WIRING:
HIGH VOLTAGE ———
LOW VOLTAGE - - - - -
FIELD WIRING:
HIGH VOLTAGE ———
LOW VOLTAGE - - - - -
 - COMPONENT CODE:
C - CONTACTOR
D/SC - DISCONNECT SWITCH
EM - EVAPORATOR MOTOR
F - FUSE
HTR - HEATER ELEMENT
R - RELAY
SEQ - SEQUENCER
TL - THERMAL LIMIT
TR - TRANSFORMER

TABLE-1

WIRE COLOR	BTUh	NOMINAL CFM
PURPLE	1800 0	600
PINK	2400 0	800
YELLOW	3000 0	950



0140A00 276-A

Wiring is subject to change. Always refer to the wiring diagram on the unit for the most up-to-date wiring.



WARNING

HIGH VOLTAGE!

DISCONNECT ALL POWER BEFORE SERVICING OR INSTALLING THIS UNIT. MULTIPLE POWER SOURCES MAY BE PRESENT. FAILURE TO DO SO MAY CAUSE PROPERTY DAMAGE, PERSONAL INJURY OR DEATH.

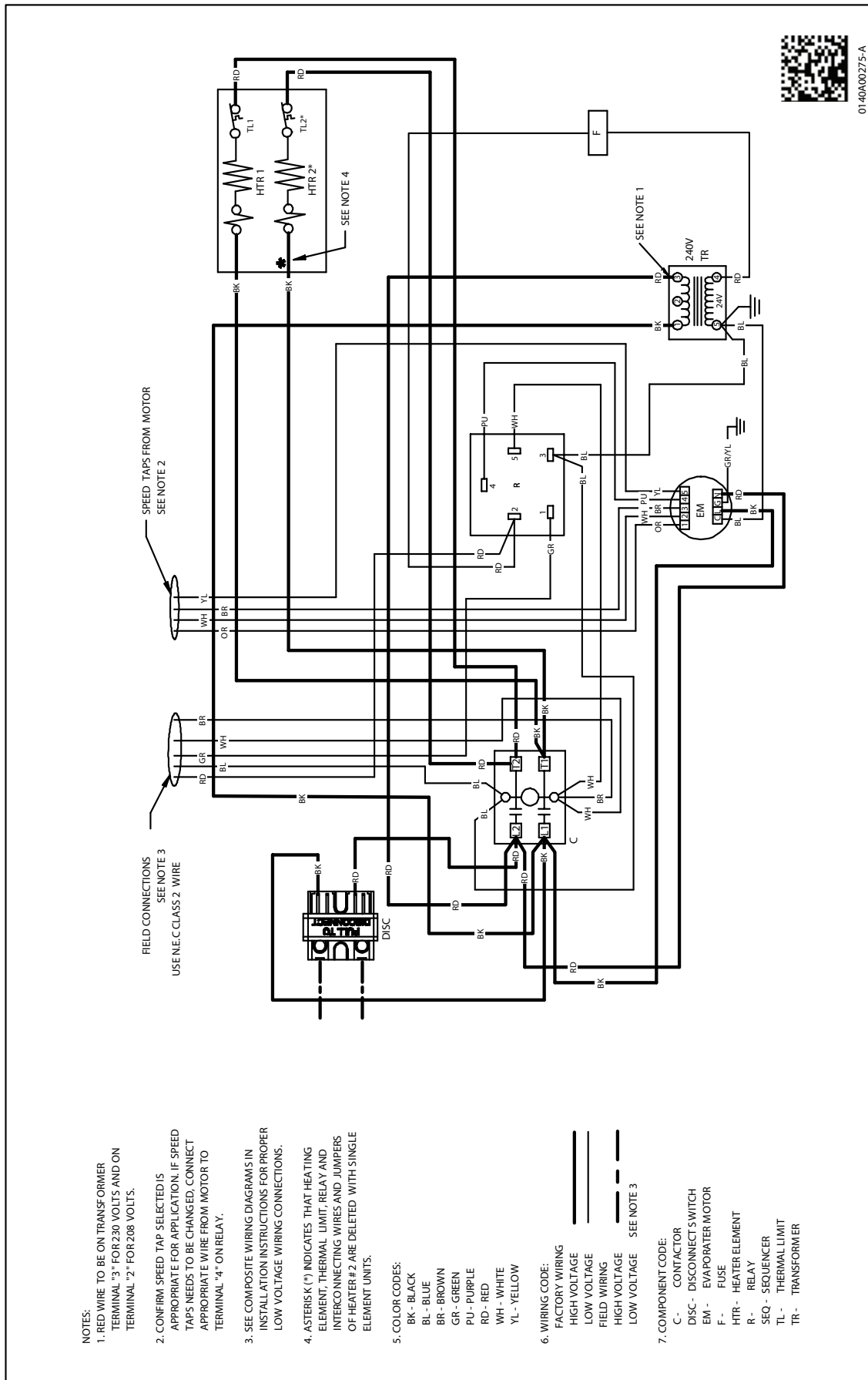

- NOTES:**
1. RED WIRE TO BE ON TRANSFORMER TERMINAL "3" FOR 230 VOLTS AND ON TERMINAL "2" FOR 208 VOLTS.
 2. CONFIRM SPEED TAP SELECTED IS APPROPRIATE FOR APPLICATION. IF SPEED TAPS NEEDS TO BE CHANGED, CONNECT APPROPRIATE WIRE FROM MOTOR TO TERMINAL "4" ON RELAY.
 3. SEE COMPOSITE WIRING DIAGRAMS IN INSTALLATION INSTRUCTIONS FOR PROPER LOW VOLTAGE WIRING CONNECTIONS.
 4. ASTERISK (*) INDICATES THAT HEATING ELEMENT, THERMAL LIMIT, RELAY AND INTERCONNECTING WIRES AND JUMBERS OF HEATER #2 ARE DELETED WITH SINGLE ELEMENT UNITS.
 5. COLOR CODES:
BK - BLACK
BL - BLUE
BR - BROWN
GR - GREEN
PU - PURPLE
RD - RED
WH - WHITE
YL - YELLOW
 6. WIRING CODE:
FACTORY WIRING
HIGH VOLTAGE
LOW VOLTAGE
FIELD WIRING
HIGH VOLTAGE
LOW VOLTAGE SEE NOTE 3
 7. COMPONENT CODE:
C - CONTACTOR
DISC - DISCONNECT SWITCH
EM - EVAPORATOR MOTOR
F - FUSE
HTR - HEATER ELEMENT
R - RELAY
SEQ - SEQUENCER
TL - THERMAL LIMIT
TR - TRANSFORMER



01-40A00275-A

Wiring is subject to change. Always refer to the wiring diagram on the unit for the most up-to-date wiring.

WARNING

HIGH VOLTAGE!

DISCONNECT ALL POWER BEFORE SERVICING OR INSTALLING THIS UNIT.
MULTIPLE POWER SOURCES MAY BE PRESENT. FAILURE TO DO SO MAY
CAUSE PROPERTY DAMAGE, PERSONAL INJURY OR DEATH.

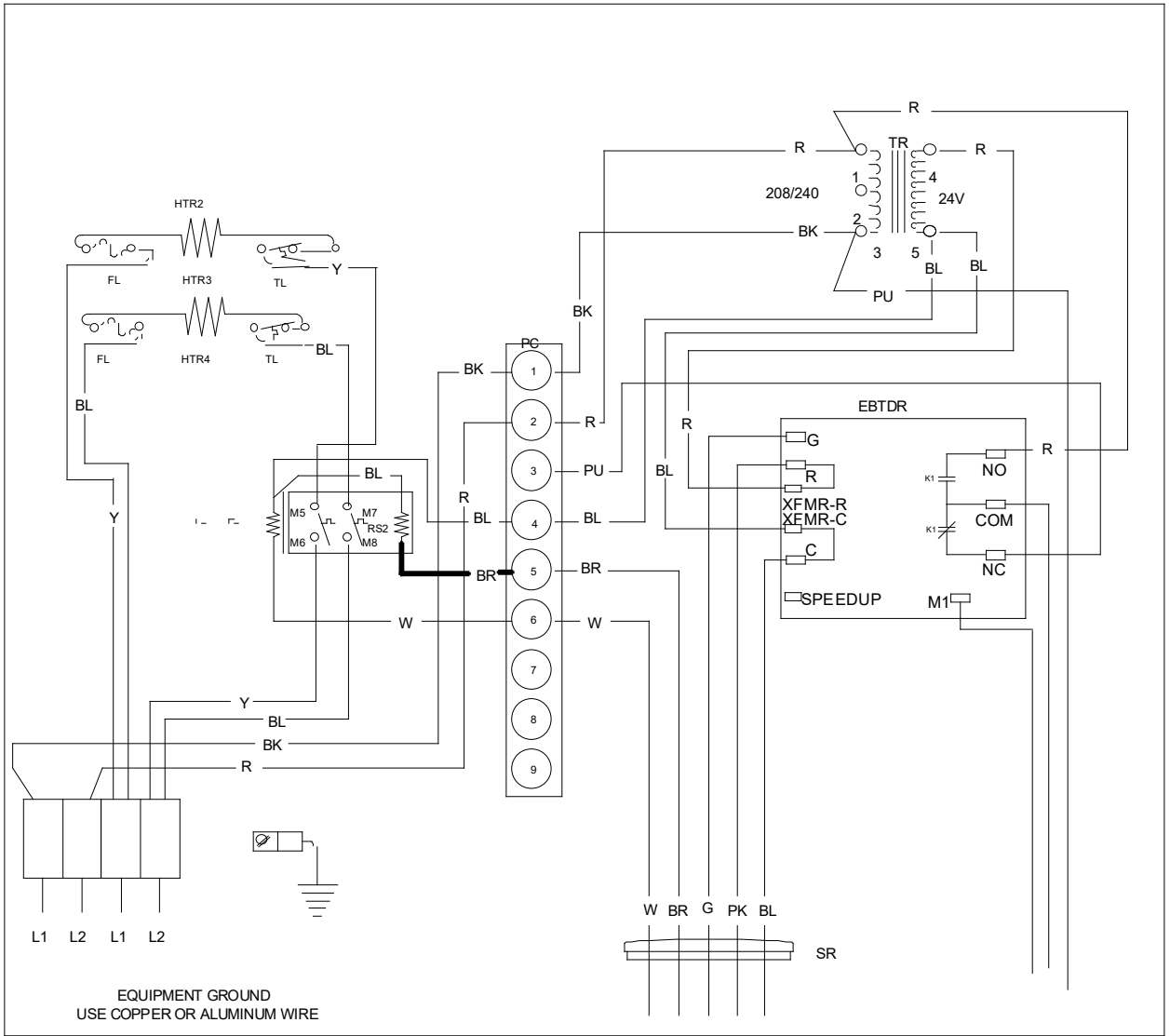

USE COPPER WIRE

Typical Wiring Schematic MBR Blower with Electric Heat.
This wiring diagram is for reference only. Not all wiring is as shown above.
Refer to the appropriate wiring diagram for the unit being serviced.

WARNING



HIGH VOLTAGE!
 DISCONNECT ALL POWER BEFORE SERVICING OR INSTALLING THIS UNIT.
 MULTIPLE POWER SOURCES MAY BE PRESENT. FAILURE TO DO SO MAY
 CAUSE PROPERTY DAMAGE, PERSONAL INJURY OR DEATH.

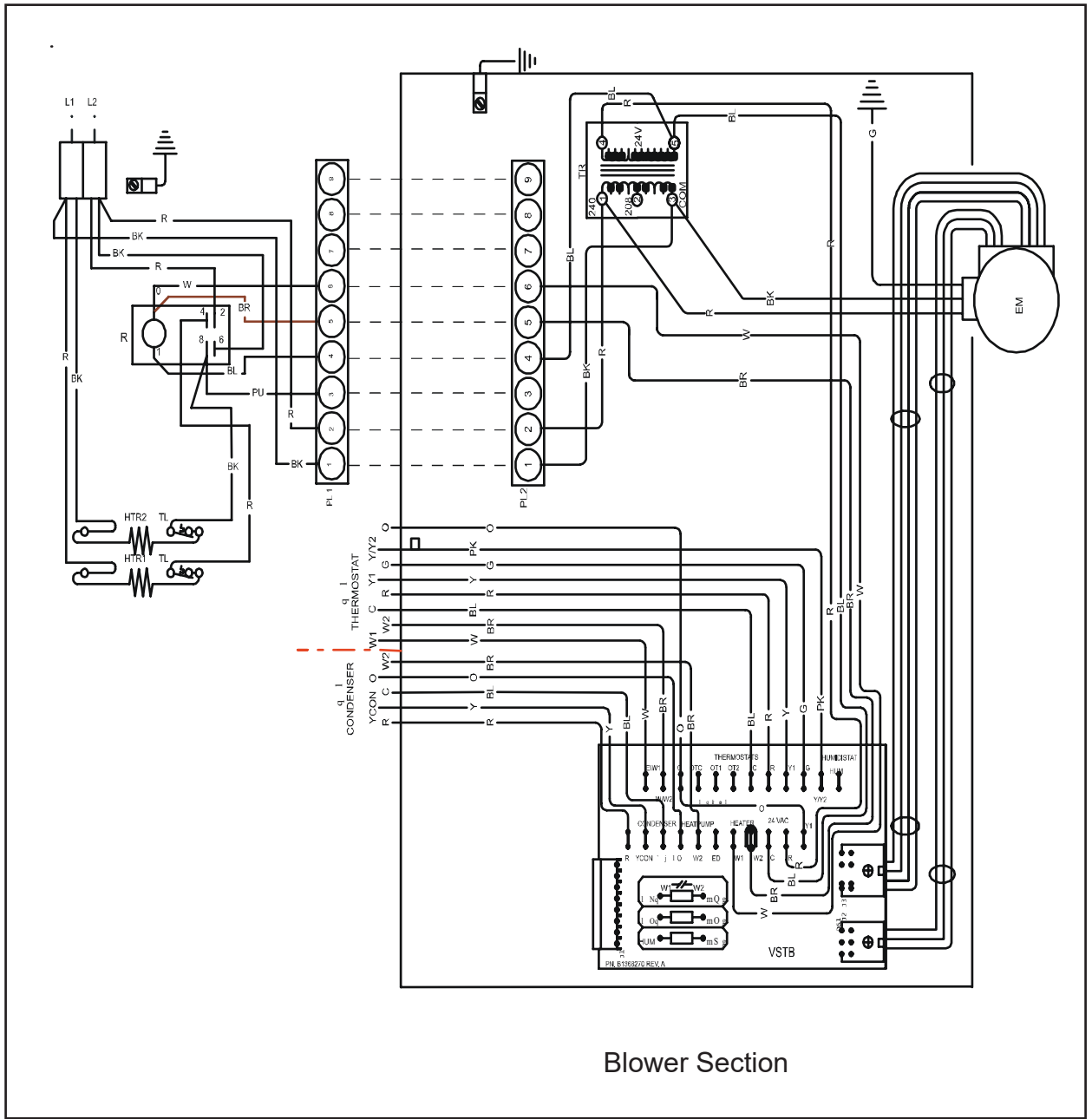

Typical Wiring Schematic MBE Blower with Electric Heat.
 This wiring diagram is for reference only.
 Not all wiring is as shown above.

Wiring is subject to change. Always refer to the wiring diagram on the unit for the most up-to-date wiring.



WARNING

HIGH VOLTAGE!

DISCONNECT ALL POWER BEFORE SERVICING OR INSTALLING THIS UNIT.
MULTIPLE POWER SOURCES MAY BE PRESENT. FAILURE TO DO SO MAY
CAUSE PROPERTY DAMAGE, PERSONAL INJURY OR DEATH.

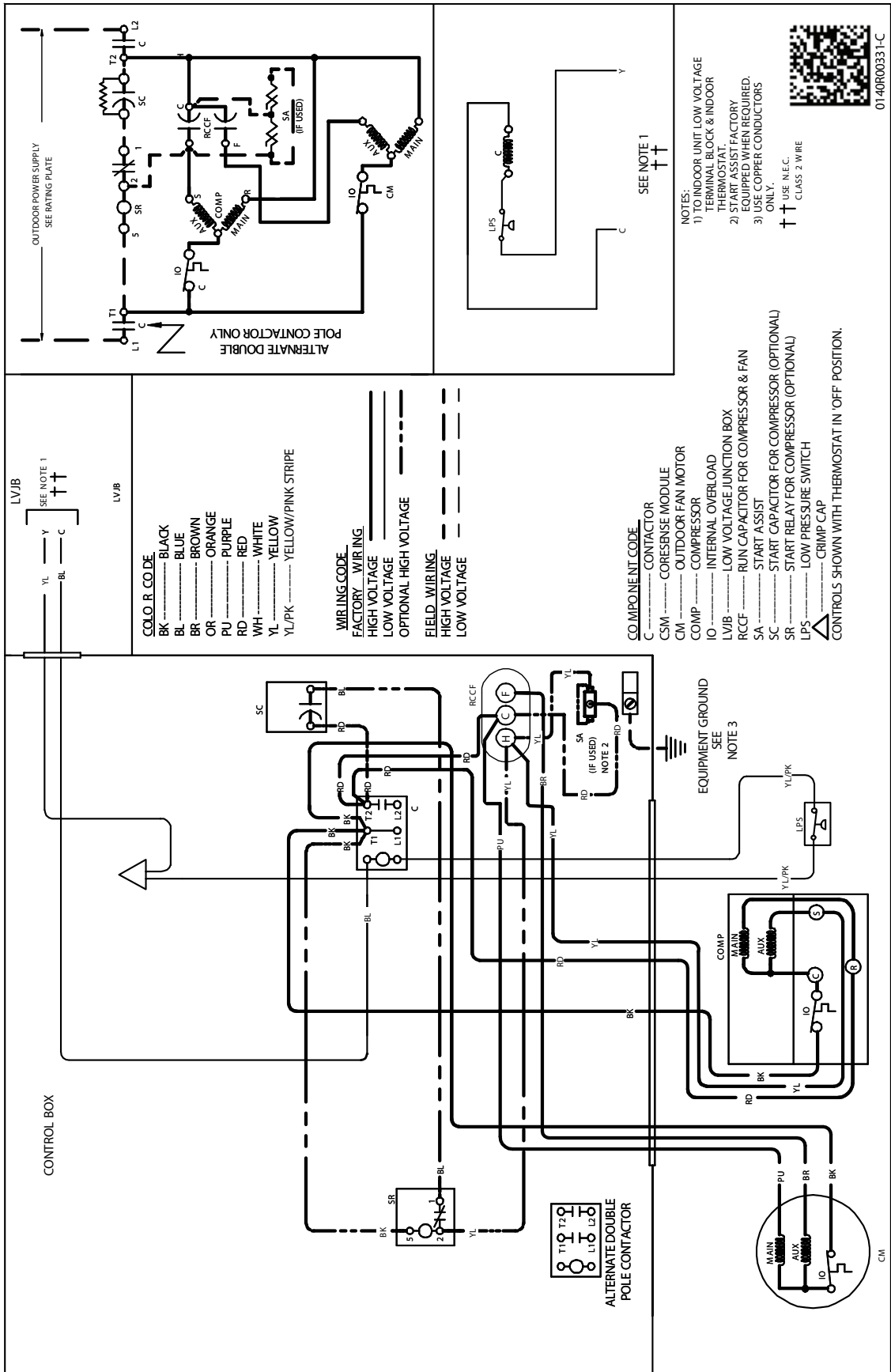

Wiring is subject to change. Always refer to the wiring diagram on the unit for the most up-to-date wiring.

WIRING DIAGRAMS

ANX130[30-61]1A*
ANX140[18-60]1A*

WARNING

HIGH VOLTAGE!

DISCONNECT ALL POWER BEFORE SERVICING OR INSTALLING THIS UNIT.
MULTIPLE POWER SOURCES MAY BE PRESENT. FAILURE TO DO SO MAY
CAUSE PROPERTY DAMAGE, PERSONAL INJURY OR DEATH.

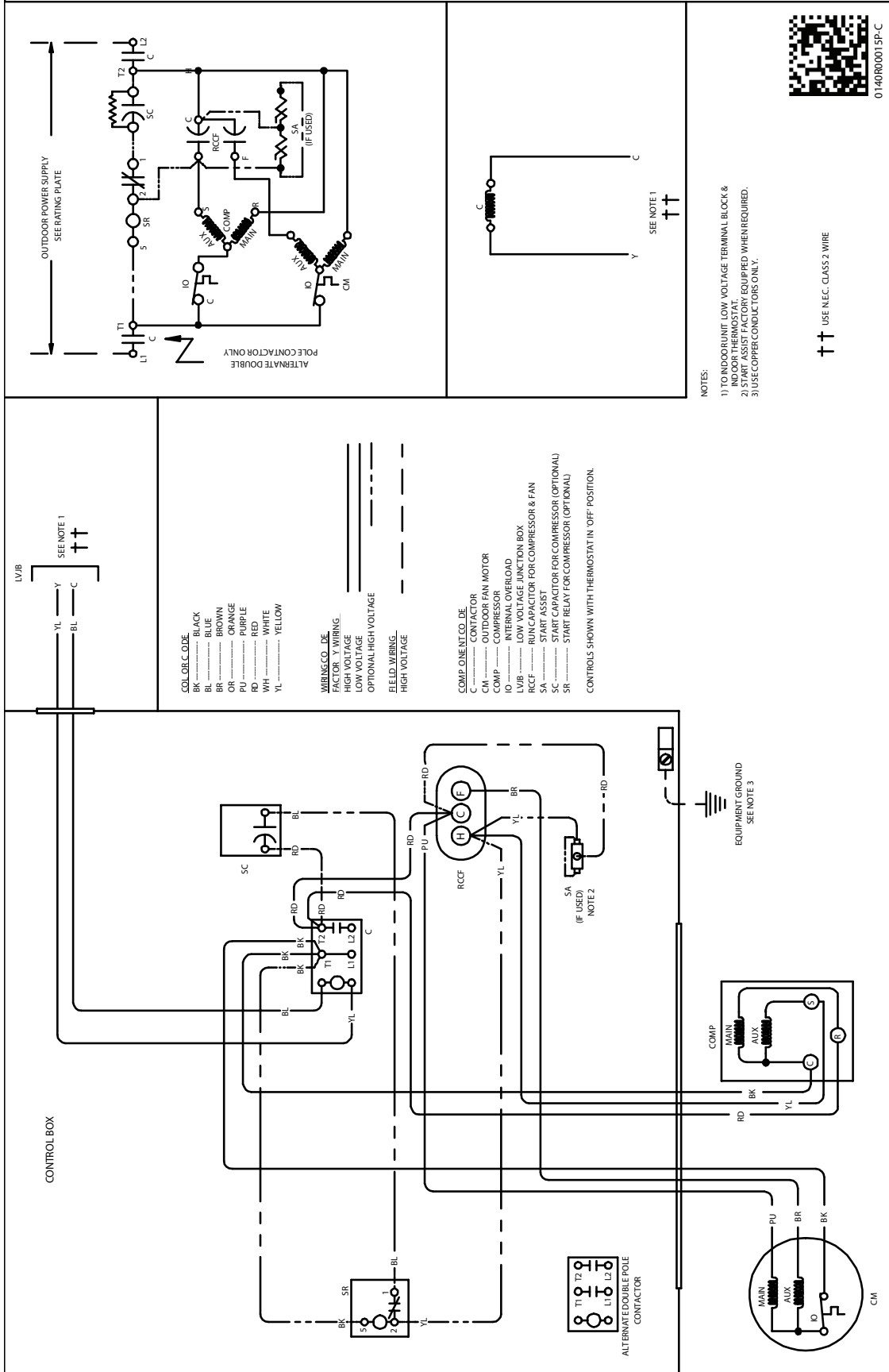

0140R00015P-C

- NOTES:
- 1) TO INDOOR UNIT LOW VOLTAGE TERMINAL BLOCK & INDOOR THERMOSTAT.
 - 2) START ASSIST FACTORY EQUIPPED WHEN REQUIRED.
 - 3) USE COPPER CONDUCTORS ONLY.

↑↑ USE NEC CLASS 2 WIRE

SEE NOTE 1

↑↑

Wiring is subject to change. Always refer to the wiring diagram on the unit for the most up-to-date wiring.



WARNING

HIGH VOLTAGE!

DISCONNECT ALL POWER BEFORE SERVICING OR INSTALLING THIS UNIT.
MULTIPLE POWER SOURCES MAY BE PRESENT. FAILURE TO DO SO MAY
CAUSE PROPERTY DAMAGE, PERSONAL INJURY OR DEATH.

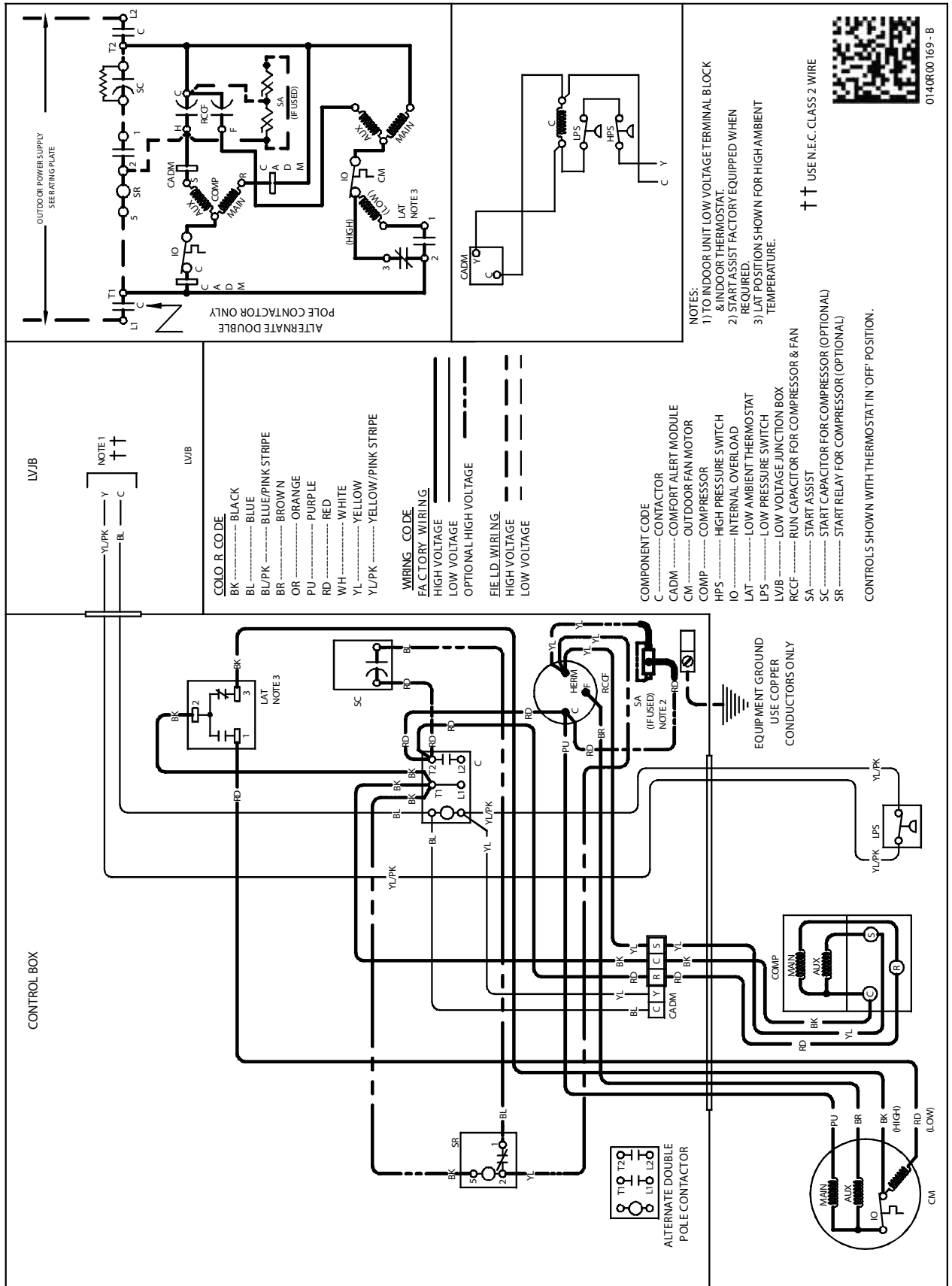

WIRING DIAGRAMS

ASX140[18-36/48]1C[A/B] ASX140421D[A/B] / ASX140[48-60]1[BA/B]



WARNING
HIGH VOLTAGE!
DISCONNECT ALL POWER BEFORE SERVICING OR INSTALLING THIS UNIT.
MULTIPLE POWER SOURCES MAY BE PRESENT. FAILURE TO DO SO MAY
CAUSE PROPERTY DAMAGE, PERSONAL INJURY OR DEATH.

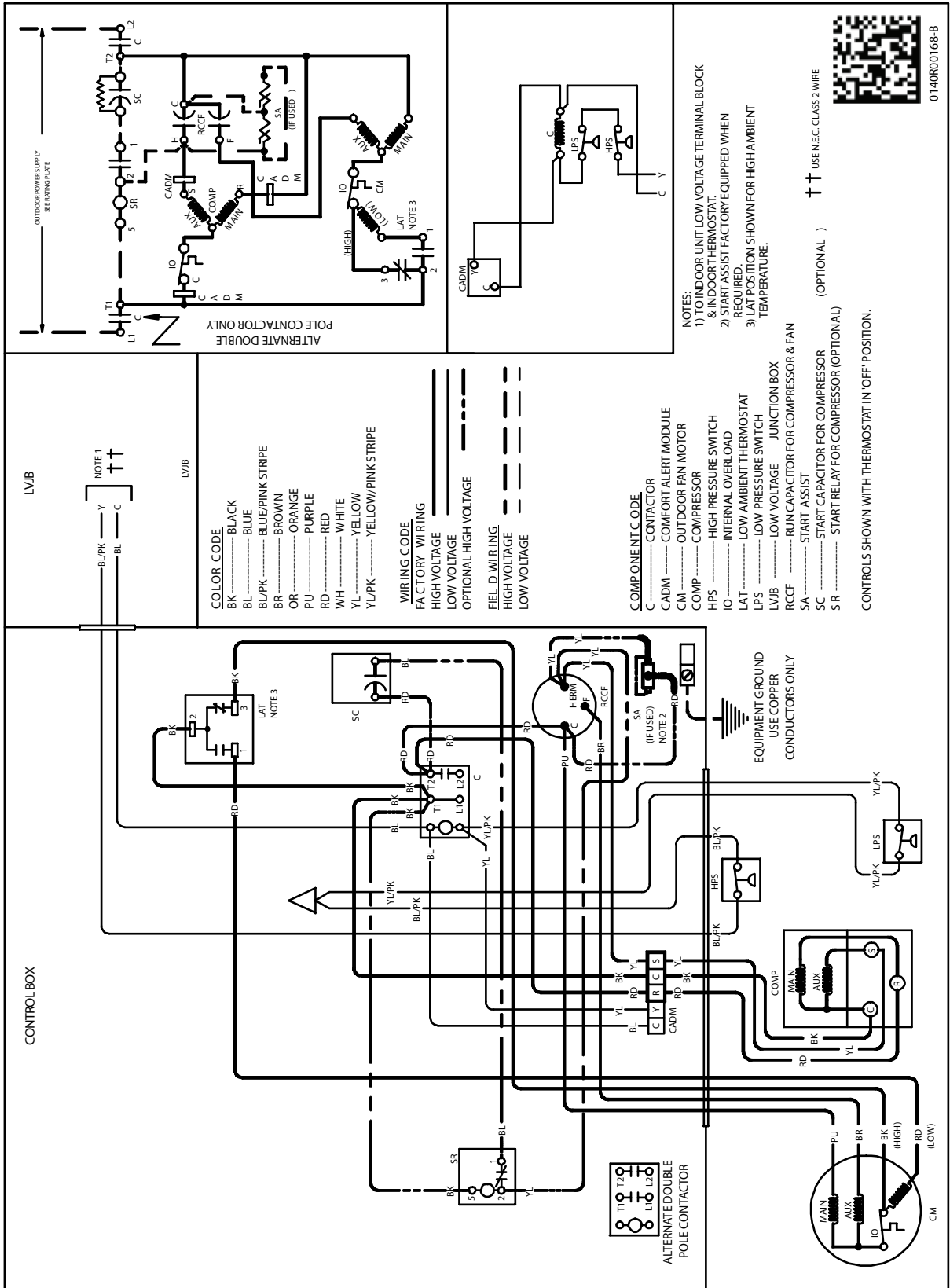

Wiring is subject to change. Always refer to the wiring diagram on the unit for the most up-to-date wiring.

WIRING DIAGRAMS

ASX140[24-36]1CD/ASX140421DD/ASX140481CC/ ASX140601BD/ ASX1401801DB/ ASX140241KB

WARNING

HIGH VOLTAGE!

DISCONNECT ALL POWER BEFORE SERVICING OR INSTALLING THIS UNIT.
MULTIPLE POWER SOURCES MAY BE PRESENT. FAILURE TO DO SO MAY
CAUSE PROPERTY DAMAGE, PERSONAL INJURY OR DEATH.

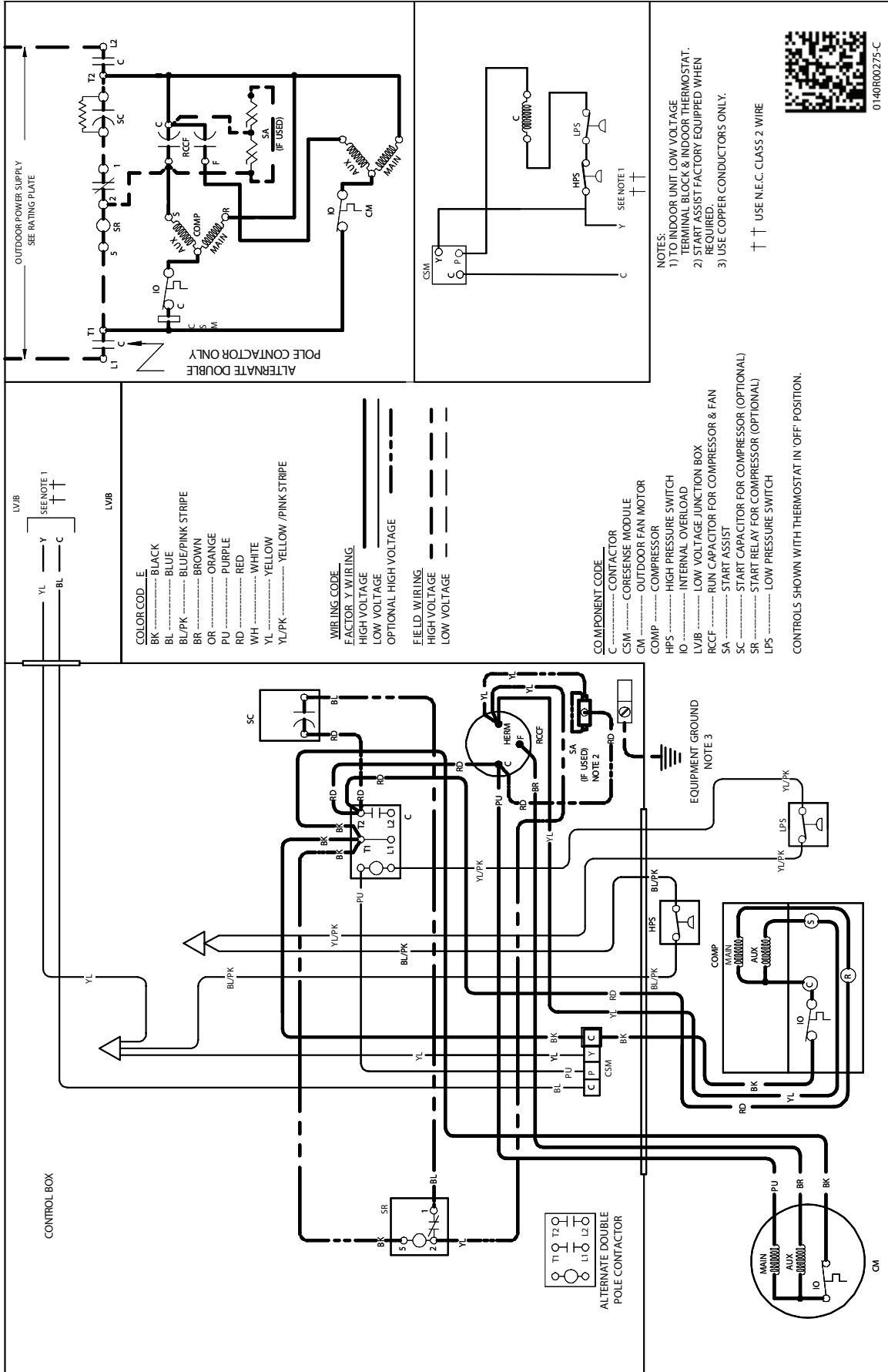

Wiring is subject to change. Always refer to the wiring diagram on the unit for the most up-to-date wiring.



WARNING
HIGH VOLTAGE!
 DISCONNECT ALL POWER BEFORE SERVICING OR INSTALLING THIS UNIT.
 MULTIPLE POWER SOURCES MAY BE PRESENT. FAILURE TO DO SO MAY
 CAUSE PROPERTY DAMAGE, PERSONAL INJURY OR DEATH.

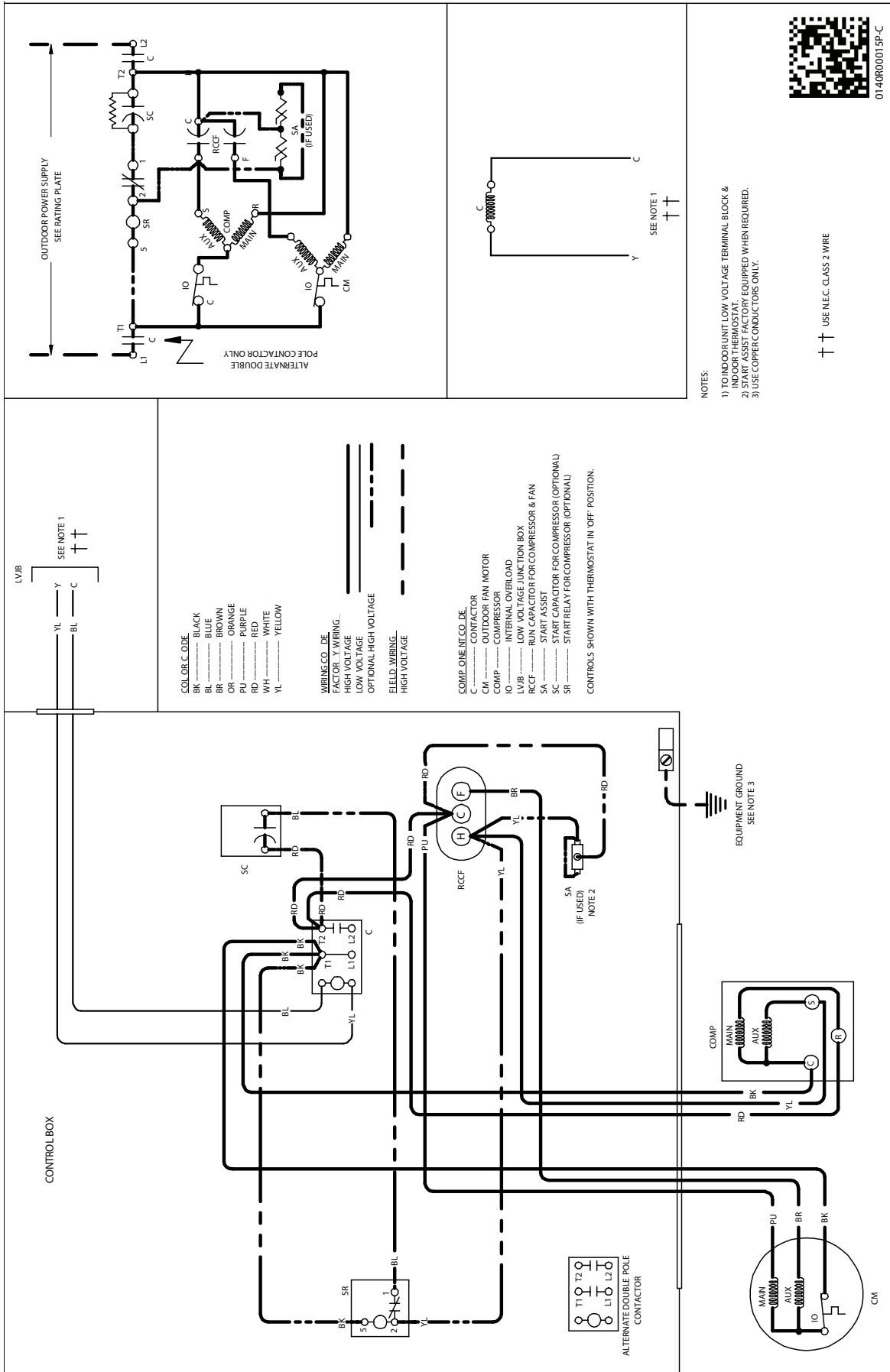

Wiring is subject to change. Always refer to the wiring diagram on the unit for the most up-to-date wiring.

WIRING DIAGRAMS

ASZ140381A*; ASZ140[18,30]1*K; ASZ140241*L;
ASZ140301*K; ASZ140421*J; ASZ140[18-30]1B*

WARNING

HIGH VOLTAGE!

DISCONNECT ALL POWER BEFORE SERVICING OR INSTALLING THIS UNIT.
MULTIPLE POWER SOURCES MAY BE PRESENT. FAILURE TO DO SO MAY
CAUSE PROPERTY DAMAGE, PERSONAL INJURY OR DEATH.

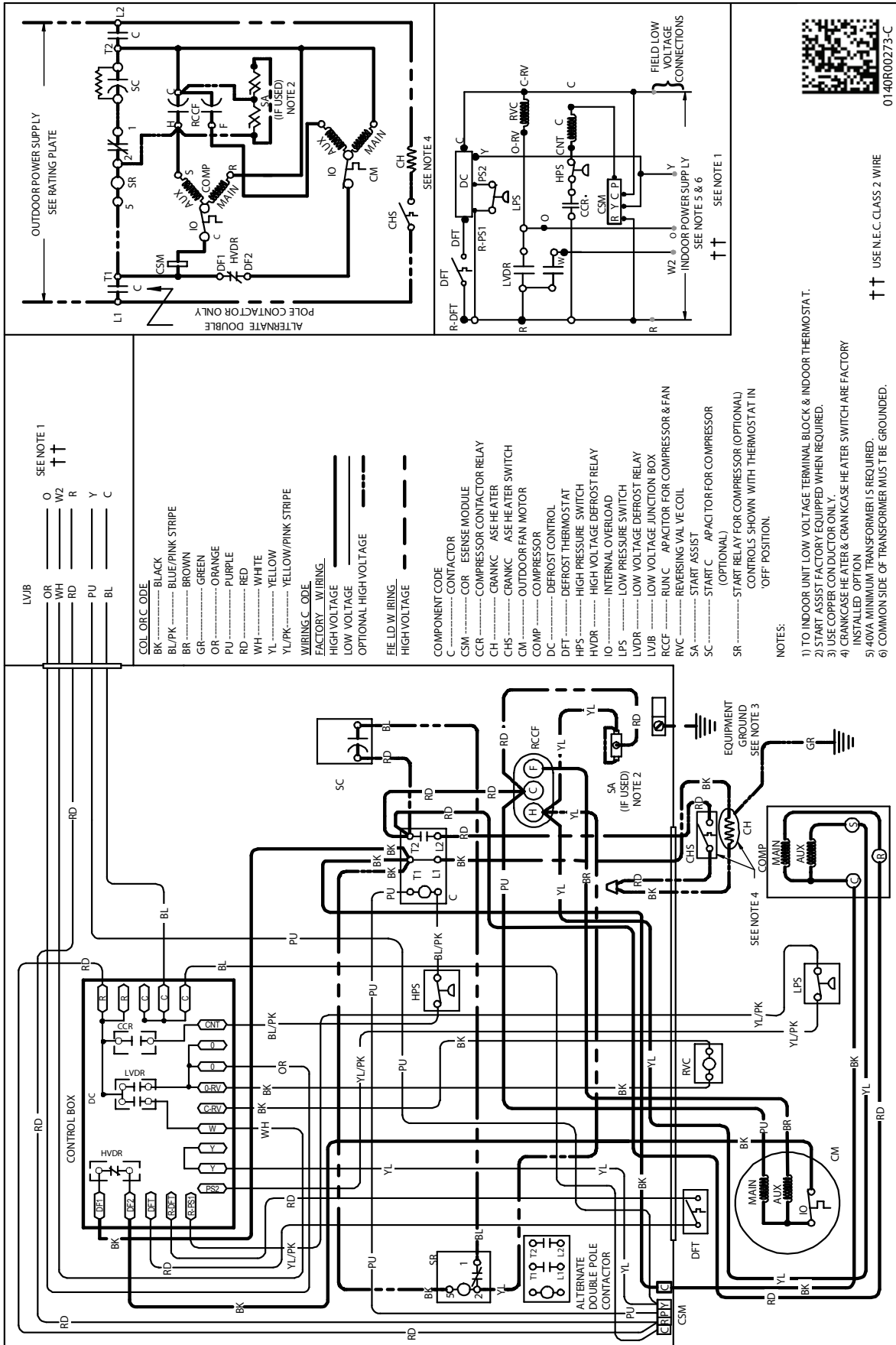

0140R00273-C

USE N.E.C. CLASS 2 WIRE

Wiring is subject to change. Always refer to the wiring diagram on the unit for the most up-to-date wiring.

WARNING

HIGH VOLTAGE!
 DISCONNECT ALL POWER BEFORE SERVICING OR INSTALLING THIS UNIT.
 MULTIPLE POWER SOURCES MAY BE PRESENT. FAILURE TO DO SO MAY
 CAUSE PROPERTY DAMAGE, PERSONAL INJURY OR DEATH.

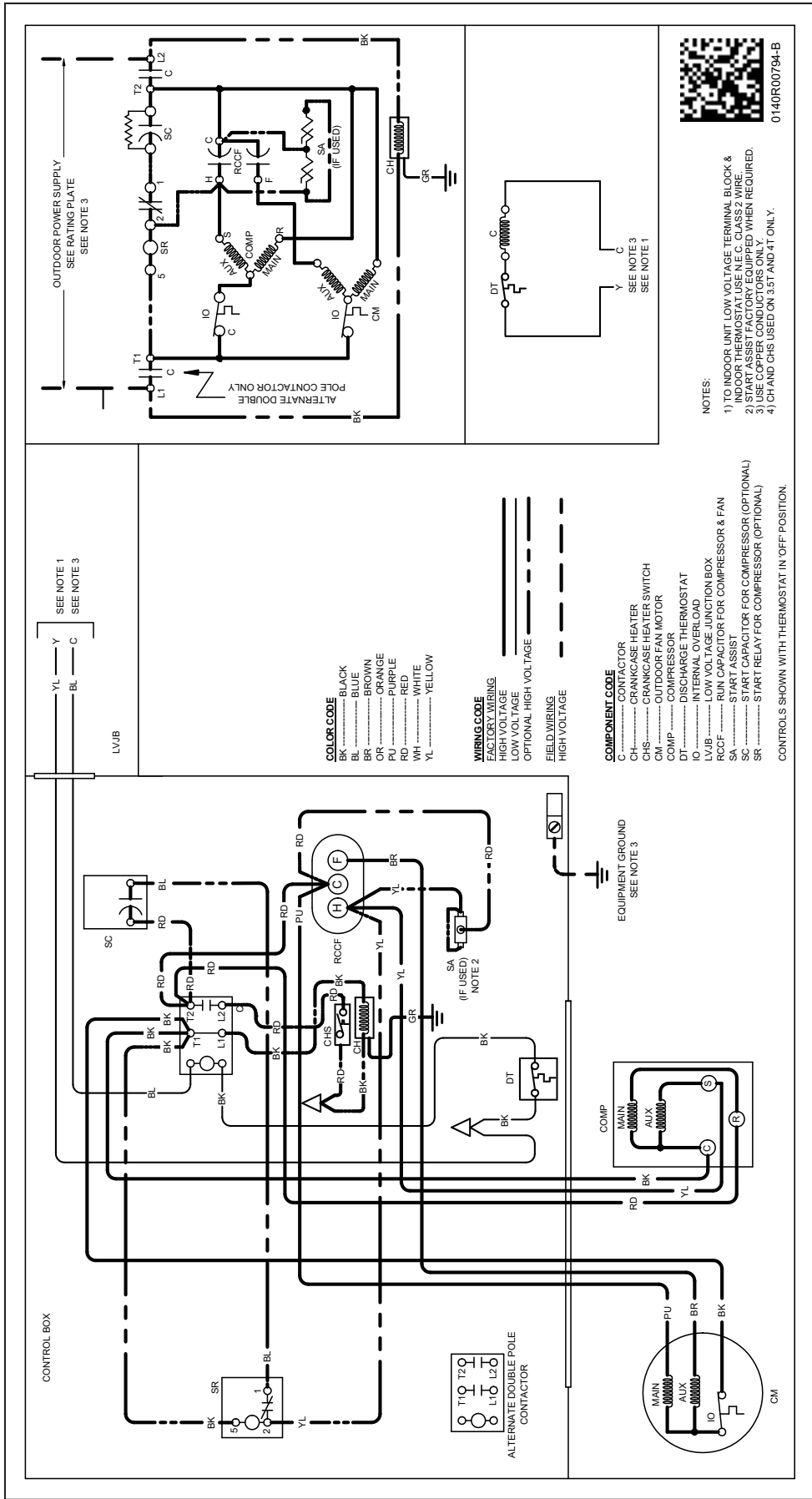

Wiring is subject to change. Always refer to the wiring diagram on the unit for the most up-to-date wiring.



WARNING

HIGH VOLTAGE!

DISCONNECT ALL POWER BEFORE SERVICING OR INSTALLING THIS UNIT.
MULTIPLE POWER SOURCES MAY BE PRESENT. FAILURE TO DO SO MAY
CAUSE PROPERTY DAMAGE, PERSONAL INJURY OR DEATH.

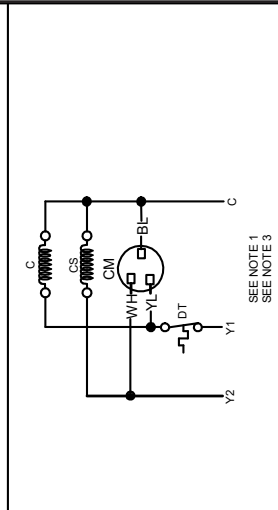
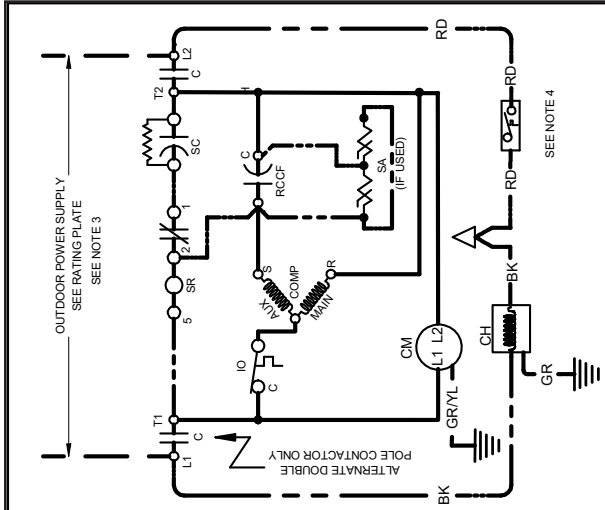
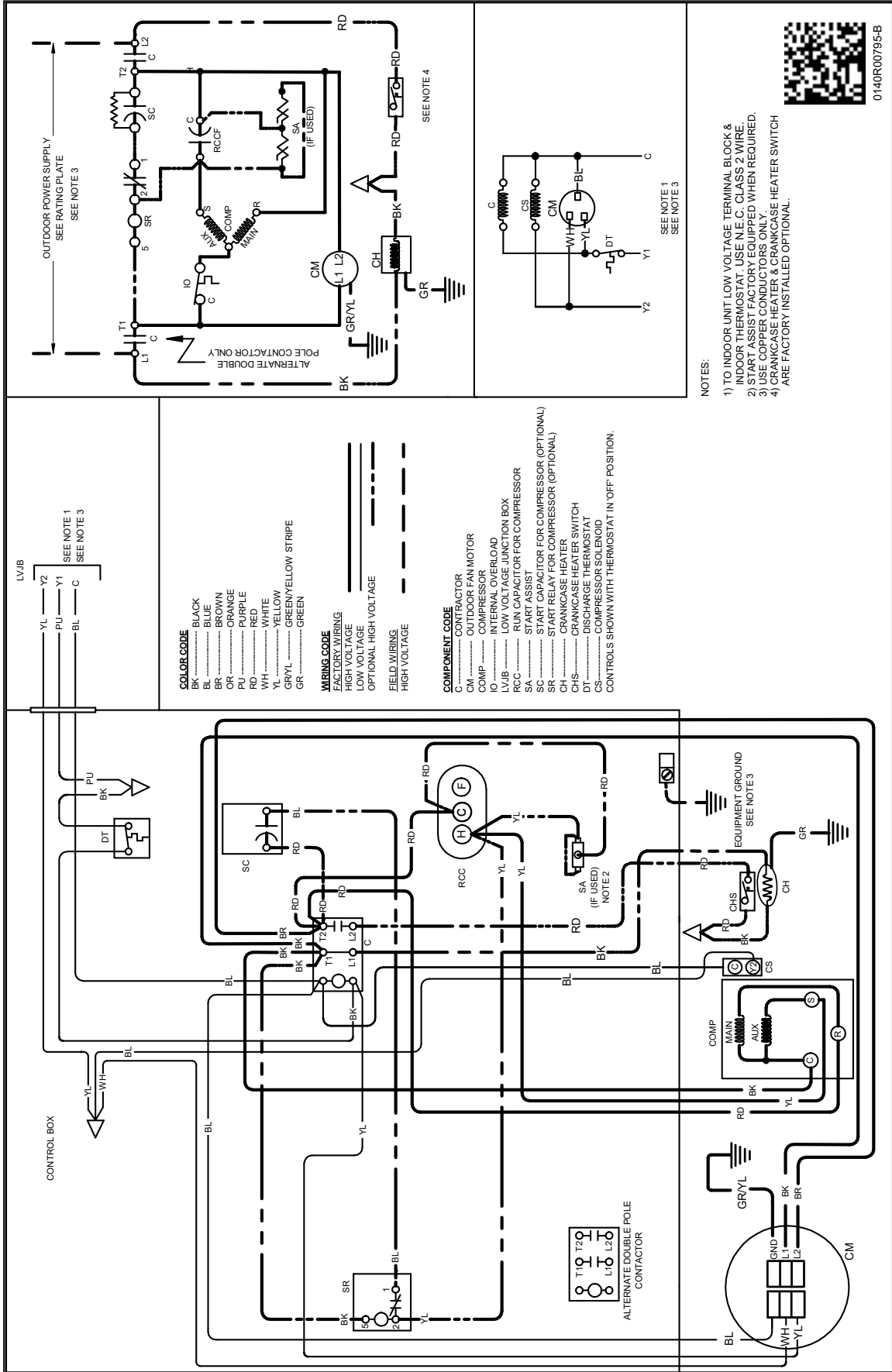

NOTES:

- 1) TO INDOOR UNIT LOW VOLTAGE TERMINAL BLOCK & INDOOR THERMOSTAT. USE N.E.C. CLASS 2 WIRE.
- 2) START ASSIST FACTORY EQUIPPED WHEN REQUIRED.
- 3) USE COPPER CONDUCTORS ONLY.
- 4) CRANKCASE HEATER & CRANKCASE HEATER SWITCH ARE FACTORY INSTALLED OPTIONAL.



0140R00795-B

Wiring is subject to change. Always refer to the wiring diagram on the unit for the most up-to-date wiring.



WARNING

HIGH VOLTAGE!
 DISCONNECT ALL POWER BEFORE SERVICING OR INSTALLING THIS UNIT.
 MULTIPLE POWER SOURCES MAY BE PRESENT. FAILURE TO DO SO MAY
 CAUSE PROPERTY DAMAGE, PERSONAL INJURY OR DEATH.

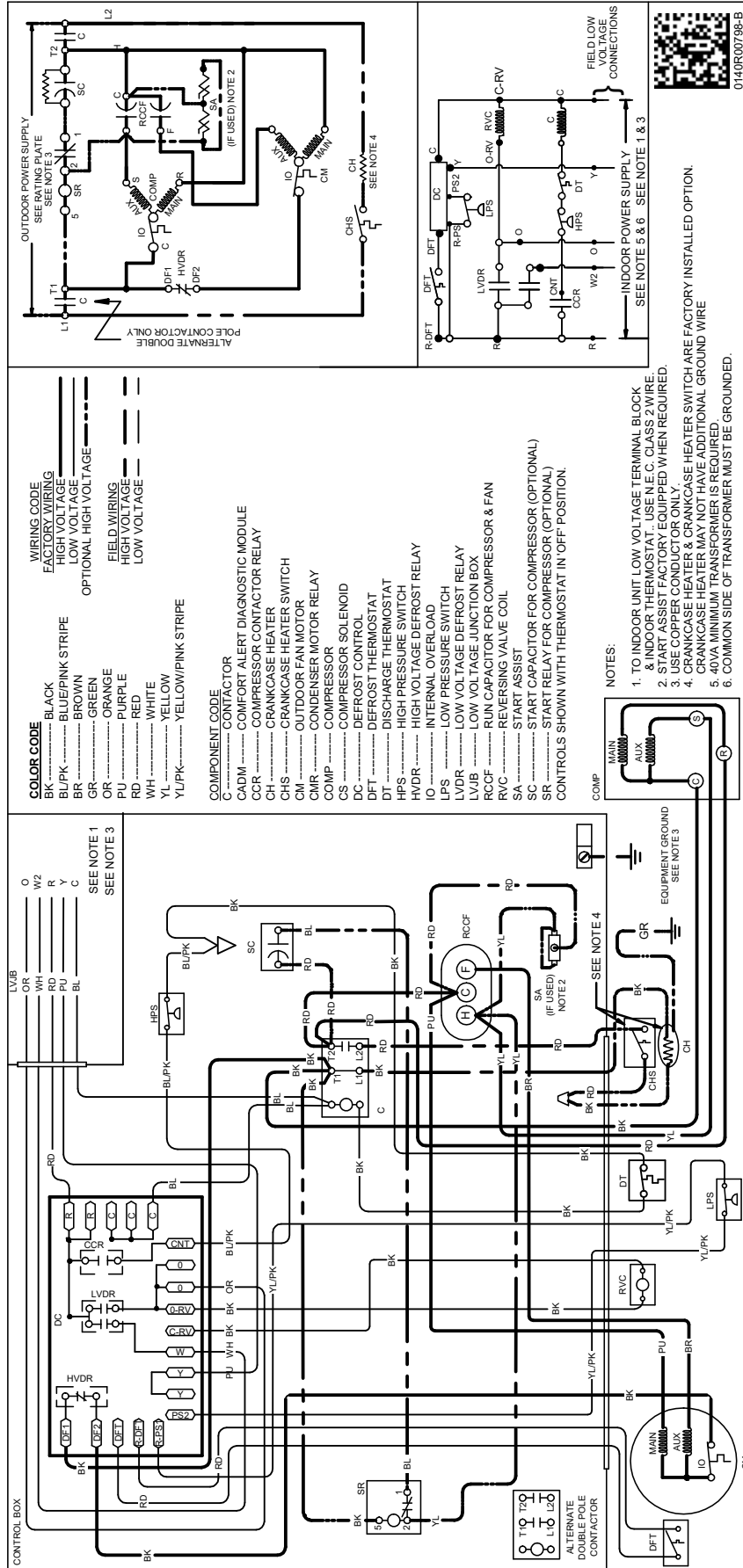

0140R00798-B

Wiring is subject to change. Always refer to the wiring diagram on the unit for the most up-to-date wiring.

WARNING

HIGH VOLTAGE!

DISCONNECT ALL POWER BEFORE SERVICING OR INSTALLING THIS UNIT.
MULTIPLE POWER SOURCES MAY BE PRESENT. FAILURE TO DO SO MAY
CAUSE PROPERTY DAMAGE, PERSONAL INJURY OR DEATH.

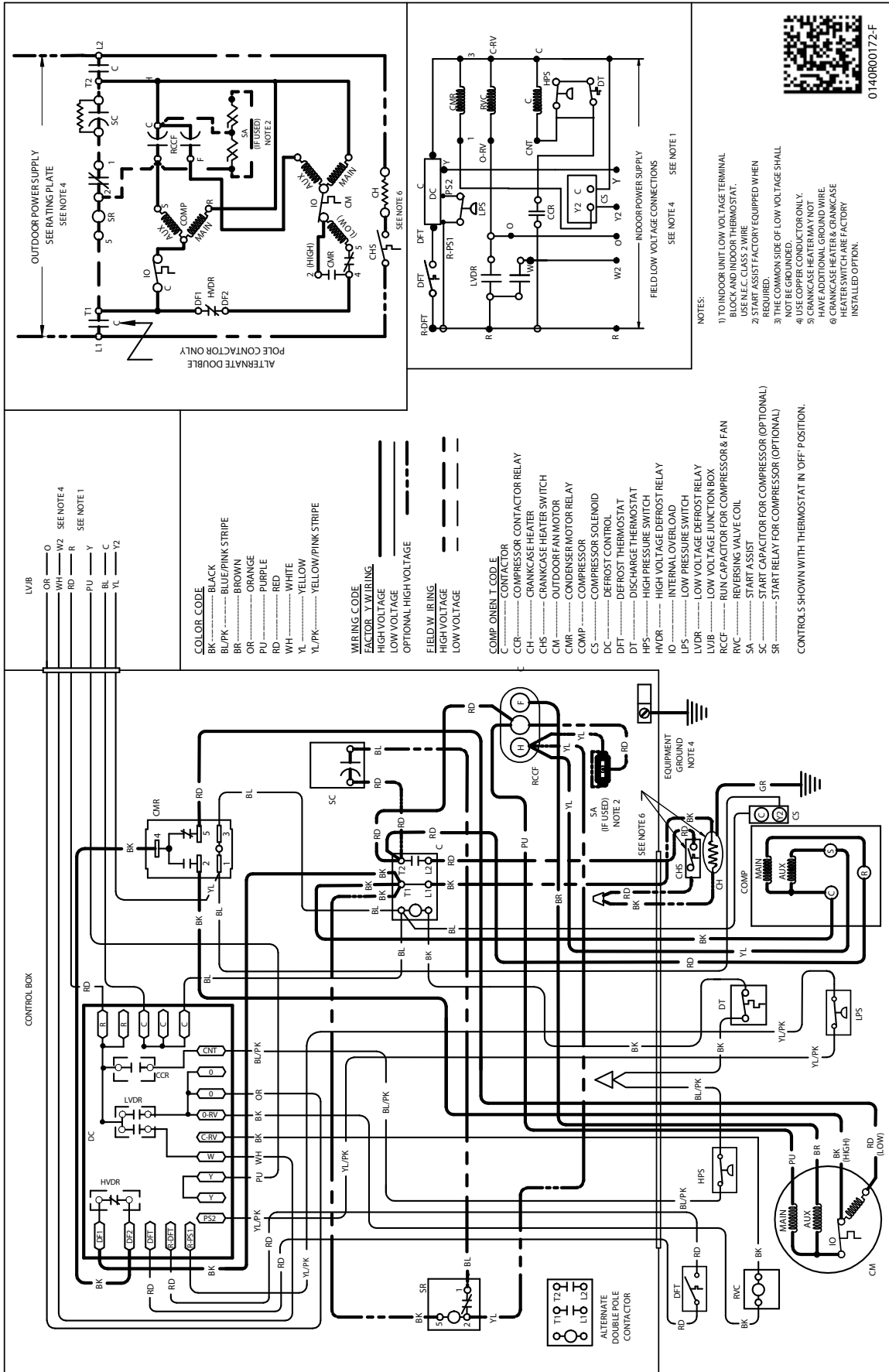

Wiring is subject to change. Always refer to the wiring diagram on the unit for the most up-to-date wiring.



WARNING

HIGH VOLTAGE!
 DISCONNECT ALL POWER BEFORE SERVICING OR INSTALLING THIS UNIT.
 MULTIPLE POWER SOURCES MAY BE PRESENT. FAILURE TO DO SO MAY
 CAUSE PROPERTY DAMAGE, PERSONAL INJURY OR DEATH.

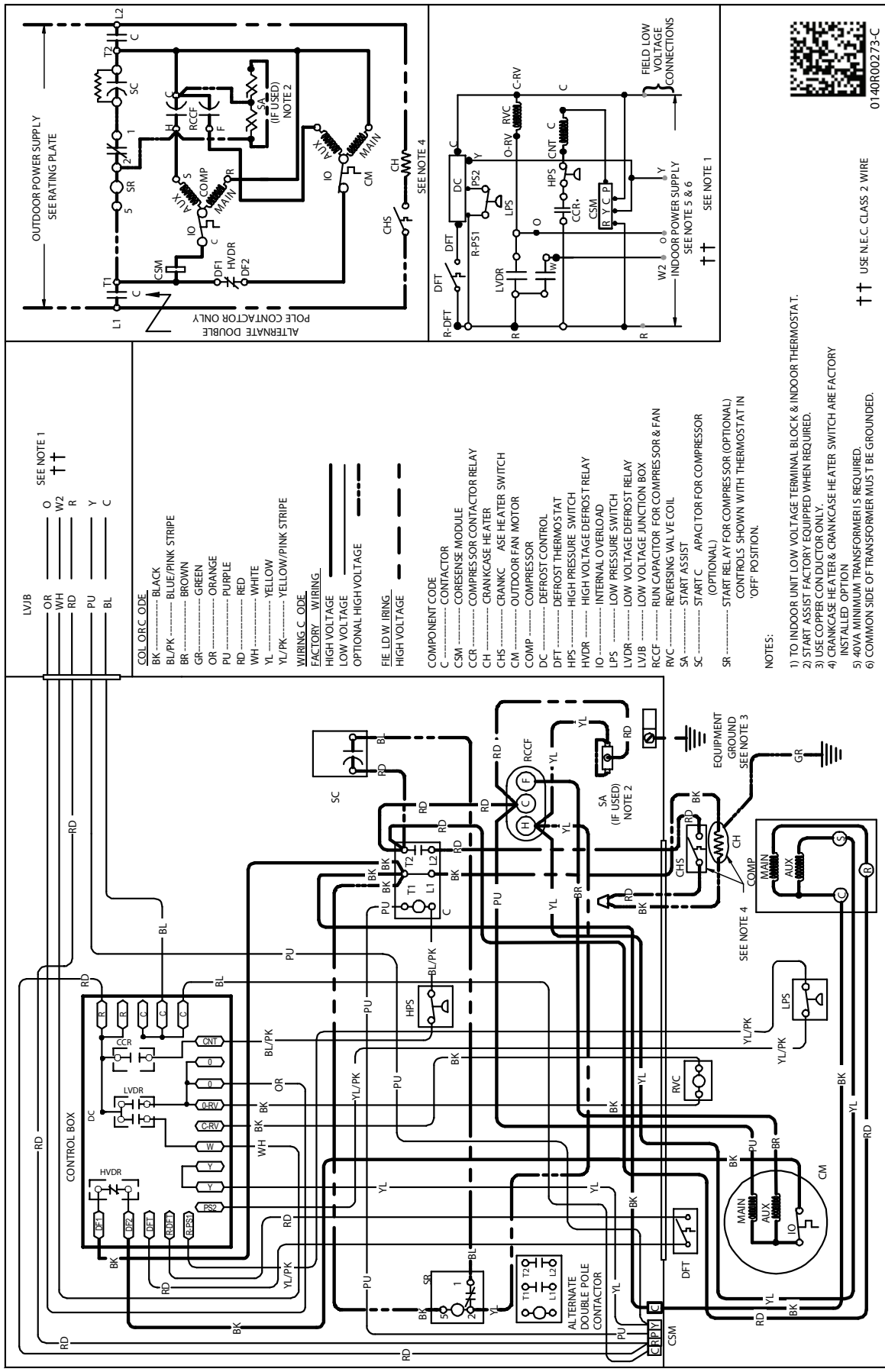

0140R00273-C

↑↑ USE N.E.C. CLASS 2 WIRE

Wiring is subject to change. Always refer to the wiring diagram on the unit for the most up-to-date wiring.

WARNING
HIGH VOLTAGE!
 DISCONNECT ALL POWER BEFORE SERVICING OR INSTALLING THIS UNIT.
 MULTIPLE POWER SOURCES MAY BE PRESENT. FAILURE TO DO SO MAY
 CAUSE PROPERTY DAMAGE, PERSONAL INJURY OR DEATH.

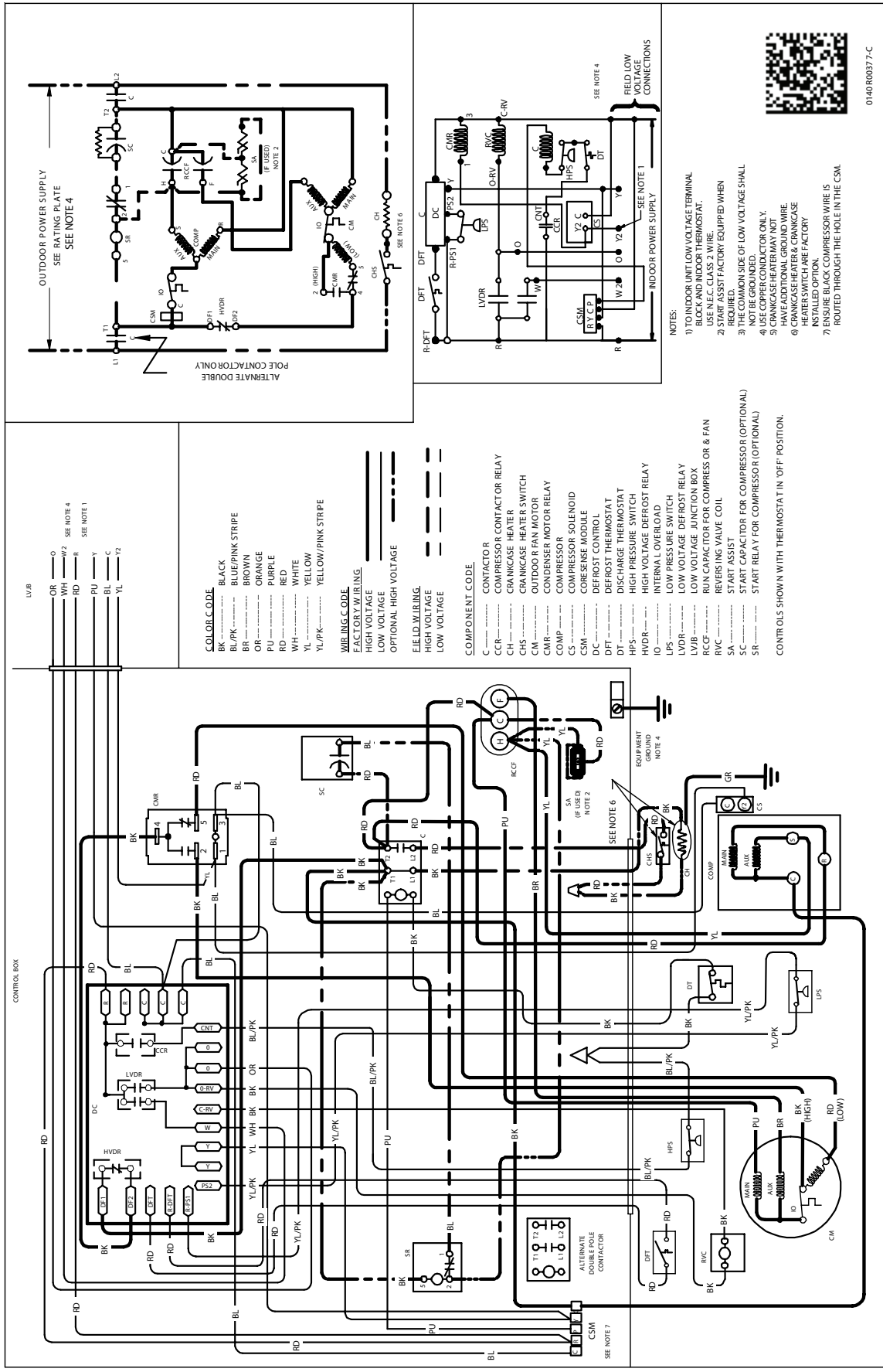

0140 R0037-C

Wiring is subject to change. Always refer to the wiring diagram on the unit for the most up-to-date wiring.

WARNING

HIGH VOLTAGE!
 DISCONNECT ALL POWER BEFORE SERVICING OR INSTALLING THIS UNIT.
 MULTIPLE POWER SOURCES MAY BE PRESENT. FAILURE TO DO SO MAY
 CAUSE PROPERTY DAMAGE, PERSONAL INJURY OR DEATH.

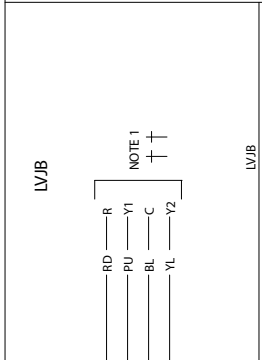
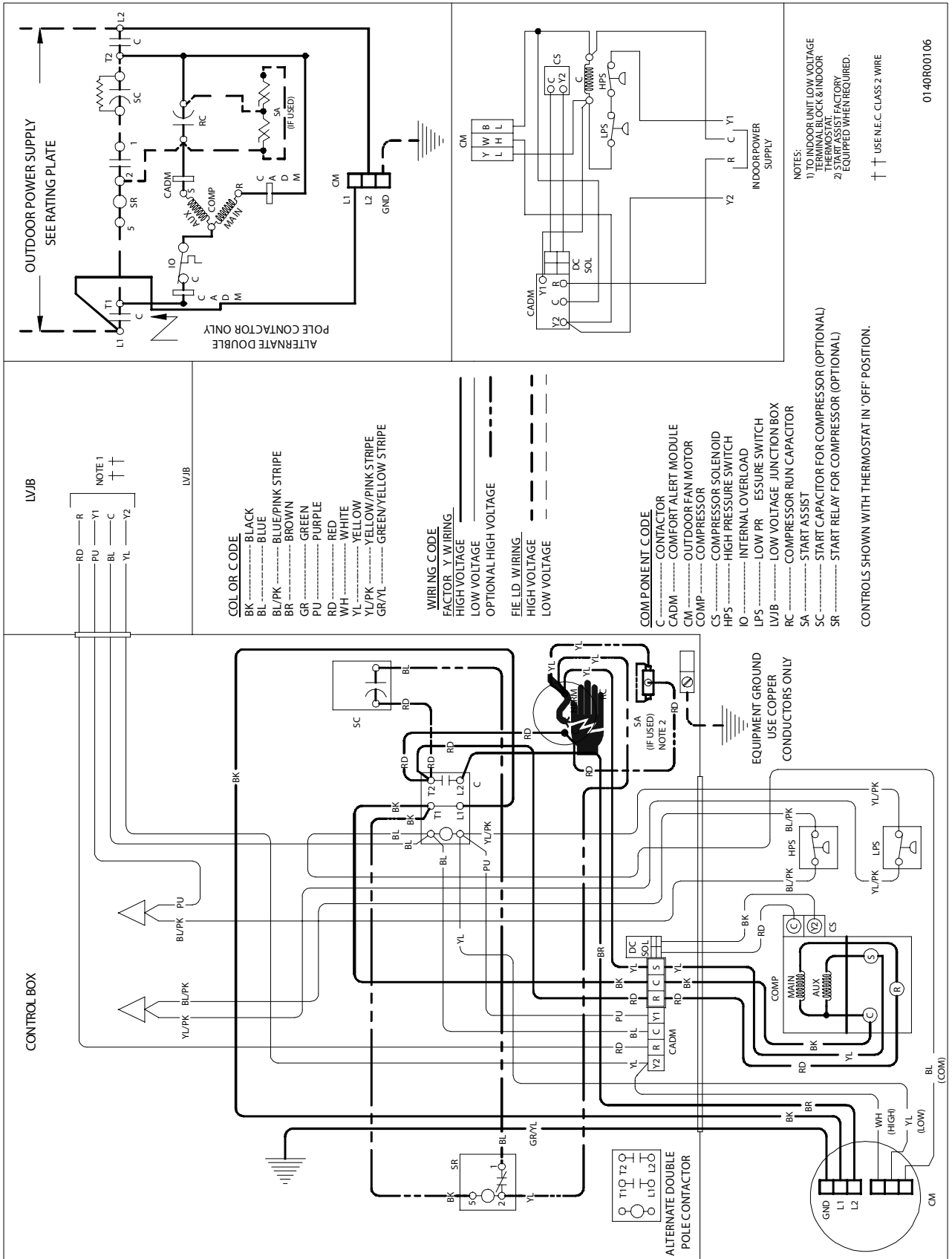

- COLOR CODE**
- BK BLACK
 - BL BLUE
 - BL/PK BLUE/PINK STRIPE
 - BR BROWN
 - GR GREEN
 - PU PURPLE
 - RD RED
 - WH WHITE
 - YL YELLOW
 - YL/PK YELLOW/PINK STRIPE
 - GR/YL GREEN/YELLOW STRIPE
- WIRING CODE**
- FACTOR Y W/IRING
 - HIGH VOLTAGE
 - LOW VOLTAGE
 - OPTIONAL HIGH VOLTAGE
- FILE L.D. W/IRING**
- HIGH VOLTAGE
 - LOW VOLTAGE

- COMPONENT CODE**
- C CONTACTOR
 - CADM COMFORT ALERT MODULE
 - CM OUTDOOR FAN MOTOR
 - COMP COMPRESSOR
 - CS COMPRESSOR SOLENOID
 - HPS HIGH PRESSURE SWITCH
 - IO INTERNAL OVERLOAD
 - LPS LOW PRESSURE SWITCH
 - LVJB LOW VOLTAGE JUNCTION BOX
 - RC COMPRESSOR RUN CAPACITOR
 - SA START ASSIST
 - SC START CAPACITOR FOR COMPRESSOR (OPTIONAL)
 - SR START RELAY FOR COMPRESSOR (OPTIONAL)
- CONTROLS SHOWN WITH THERMOSTAT IN 'OFF' POSITION.

NOTES:
 1) TO INDOOR UNIT LOW VOLTAGE TERMINAL BLOCK & INDOOR THERMOSTAT.
 2) START ASSIST FACTORY EQUIPPED WHEN REQUIRED.
 ++ USE N.E.C. CLASS 2 WIRE

0140R00106

Wiring is subject to change. Always refer to the wiring diagram on the unit for the most up-to-date wiring.



WARNING

HIGH VOLTAGE!
 DISCONNECT ALL POWER BEFORE SERVICING OR INSTALLING THIS UNIT.
 MULTIPLE POWER SOURCES MAY BE PRESENT. FAILURE TO DO SO MAY
 CAUSE PROPERTY DAMAGE, PERSONAL INJURY OR DEATH.

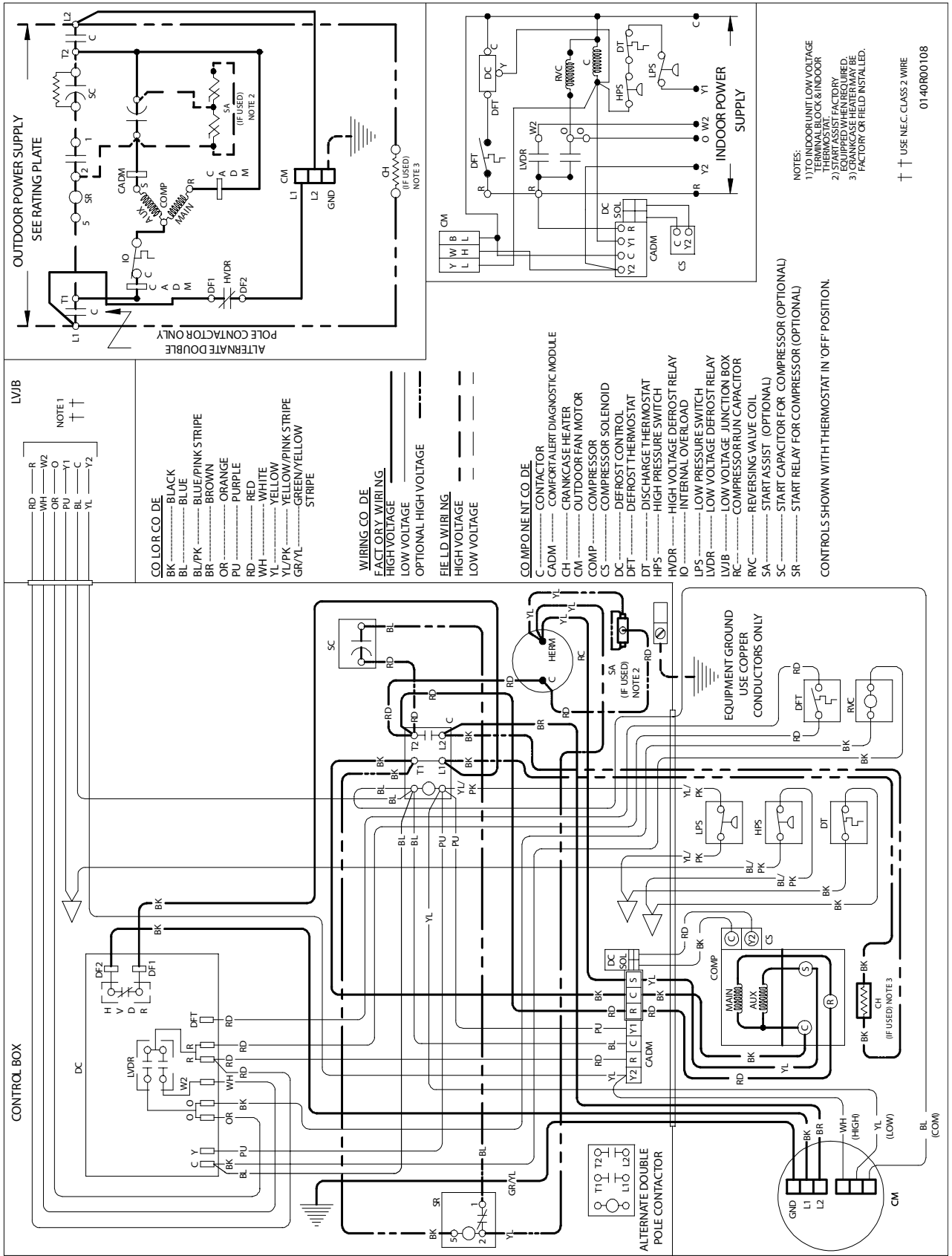

Wiring is subject to change. Always refer to the wiring diagram on the unit for the most up-to-date wiring.



WARNING

HIGH VOLTAGE!

DISCONNECT ALL POWER BEFORE SERVICING OR INSTALLING THIS UNIT.
MULTIPLE POWER SOURCES MAY BE PRESENT. FAILURE TO DO SO MAY
CAUSE PROPERTY DAMAGE, PERSONAL INJURY OR DEATH.

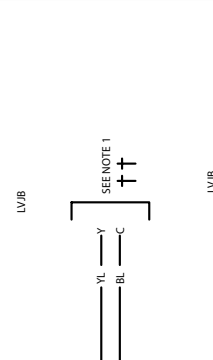
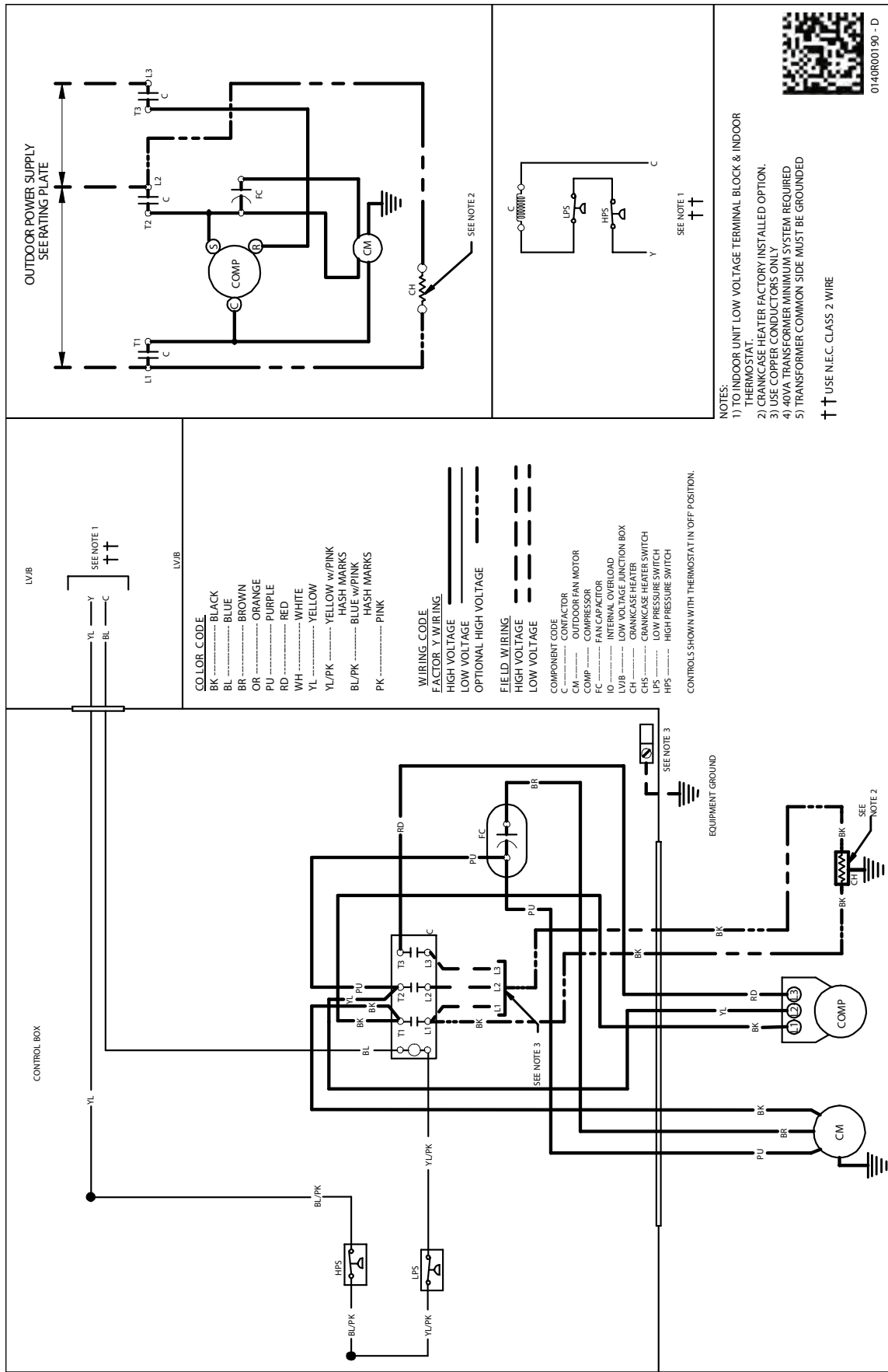

- COLOR CODE**
- BK BLACK
 - BL BLUE
 - BR BROWN
 - OR ORANGE
 - PU PURPLE
 - RD RED
 - WH WHITE
 - YL YELLOW
 - YL/PK YELLOW w/PINK
 - HASH MARKS
 - BL/PK BLUE w/PINK
 - HASH MARKS
 - PK PINK
- WIRING CODE**
- FACTOR Y WIRING
 - HIGH VOLTAGE
 - LOW VOLTAGE
 - OPTIONAL HIGH VOLTAGE
- FIELD WIRING**
- HIGH VOLTAGE
 - LOW VOLTAGE
- COMPONENT CODE**
- C CONTACTOR
 - CM COMPRESSOR MOTOR
 - CH CRANKCASE HEATER
 - FC FAN CAPACITOR
 - FM FAN MOTOR
 - IO INTERNAL OVERLOAD
 - LV/B LOW VOLTAGE JUNCTION BOX
 - CH CRANKCASE HEATER
 - CHS CRANKCASE HEATER SWITCH
 - LPS LOW PRESSURE SWITCH
 - HPS HIGH PRESSURE SWITCH
- CONTROLS SHOWN WITH THERMOSTAT IN 'OFF' POSITION.

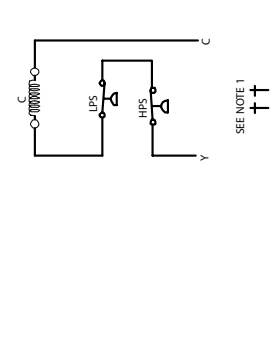
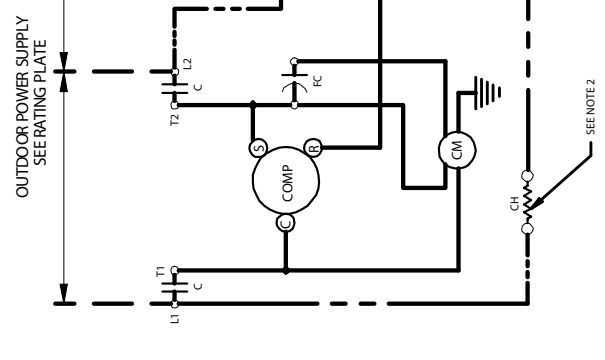

- NOTES:**
- 1) TO INDOOR UNIT LOW VOLTAGE TERMINAL BLOCK & INDOOR THERMOSTAT.
 - 2) CRANKCASE HEATER FACTORY INSTALLED OPTION.
 - 3) USE COPPER CONDUCTORS ONLY.
 - 4) 40VA TRANSFORMER MINIMUM SYSTEM REQUIRED
 - 5) TRANSFORMER COMMON SIDE MUST BE GROUNDED
- †† USE N.E.C. CLASS 2 WIRE



0140R00190 - D

Wiring is subject to change. Always refer to the wiring diagram on the unit for the most up-to-date wiring.



WARNING

HIGH VOLTAGE!

DISCONNECT ALL POWER BEFORE SERVICING OR INSTALLING THIS UNIT.
MULTIPLE POWER SOURCES MAY BE PRESENT. FAILURE TO DO SO MAY
CAUSE PROPERTY DAMAGE, PERSONAL INJURY OR DEATH.

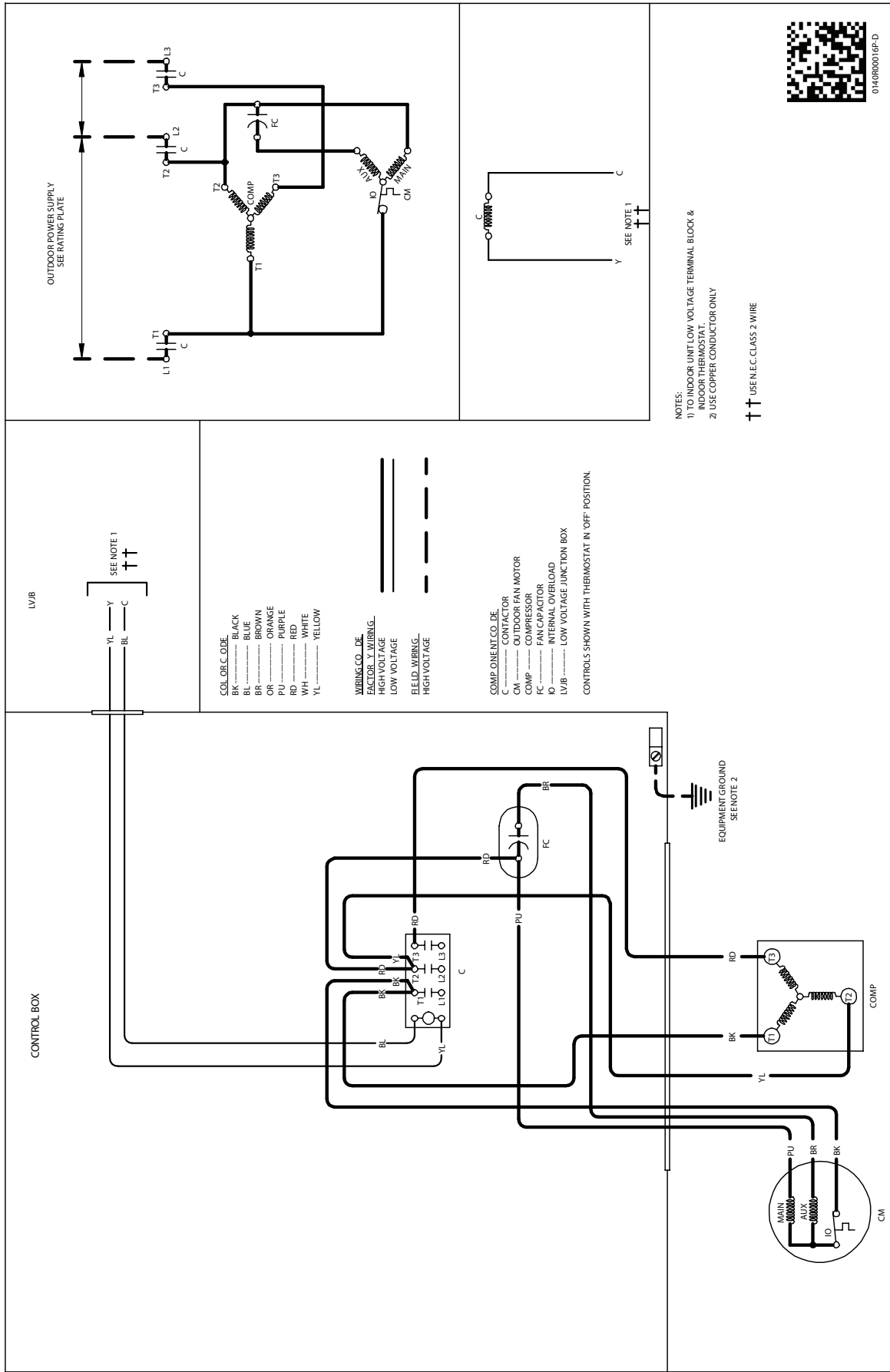

Wiring is subject to change. Always refer to the wiring diagram on the unit for the most up-to-date wiring.



WARNING
HIGH VOLTAGE!
 DISCONNECT ALL POWER BEFORE SERVICING OR INSTALLING THIS UNIT.
 MULTIPLE POWER SOURCES MAY BE PRESENT. FAILURE TO DO SO MAY
 CAUSE PROPERTY DAMAGE, PERSONAL INJURY OR DEATH.

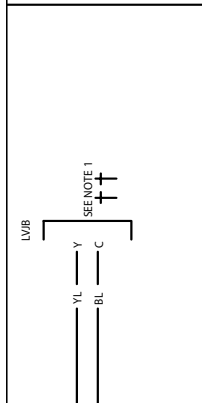
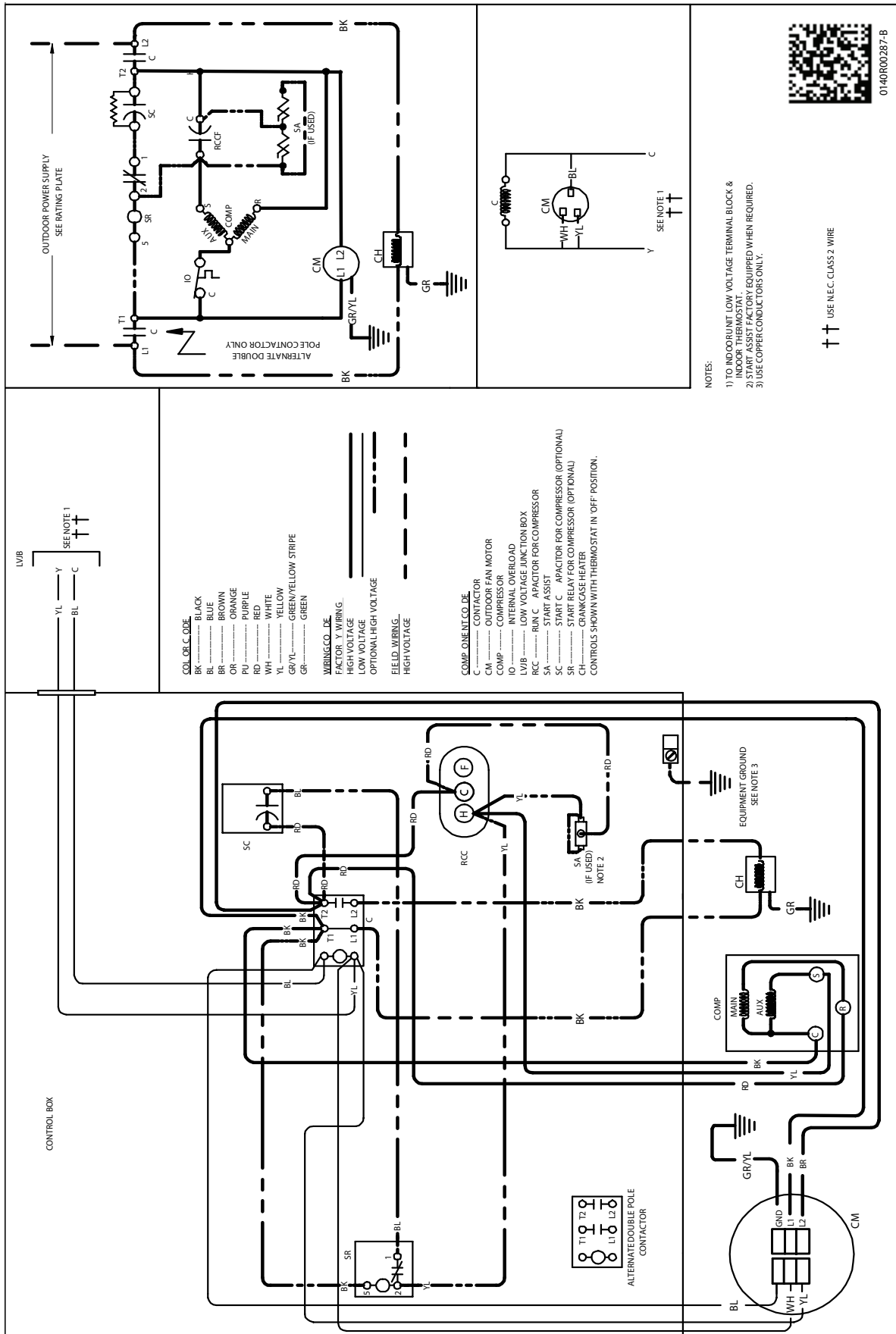

- COLOR CODE**
 BK — BLACK
 BL — BLUE
 BR — BROWN
 OR — ORANGE
 PU — PURPLE
 RD — RED
 WH — WHITE
 YL — YELLOW
 GR/YL — GREEN/YELLOW STRIPE
 GR — GREEN
- WIRING CODE**
 BK — FACTOR Y WIRING
 HIGH VOLTAGE
 LOW VOLTAGE
 OPTIONAL HIGH VOLTAGE
 FIELD WIRING
 HIGH VOLTAGE
- COMPONENT CODE**
 C — CONTACTOR
 CM — OUTDOOR FAN MOTOR
 COMP — COMPRESSOR
 IO — INTERNAL OVERLOAD
 LVB — LOW VOLTAGE JUNCTION BOX
 RCC — RUN C APACTOR FOR COMPRESSOR
 SA — START ASSIST
 SC — START RELAY FOR COMPRESSOR (OPTIONAL)
 SR — START RELAY FOR COMPRESSOR (OPTIONAL)
 CH — CRANKCASE HEATER
 CONTROLS SHOWN WITH THERMOSTAT IN OFF POSITION.

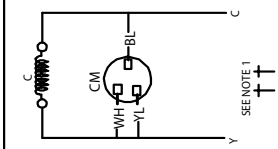

- NOTES:**
 1) TO INDOOR UNIT LOW VOLTAGE TERMINAL BLOCK & INDOOR THERMOSTAT.
 2) START ASSIST FACTORY EQUIPPED WHEN REQUIRED.
 3) USE COPPER CONDUCTORS ONLY.

†† USE N.E.C. CLASS 2 WIRE



Wiring is subject to change. Always refer to the wiring diagram on the unit for the most up-to-date wiring.



WARNING
HIGH VOLTAGE!
 DISCONNECT ALL POWER BEFORE SERVICING OR INSTALLING THIS UNIT.
 MULTIPLE POWER SOURCES MAY BE PRESENT. FAILURE TO DO SO MAY
 CAUSE PROPERTY DAMAGE, PERSONAL INJURY OR DEATH.

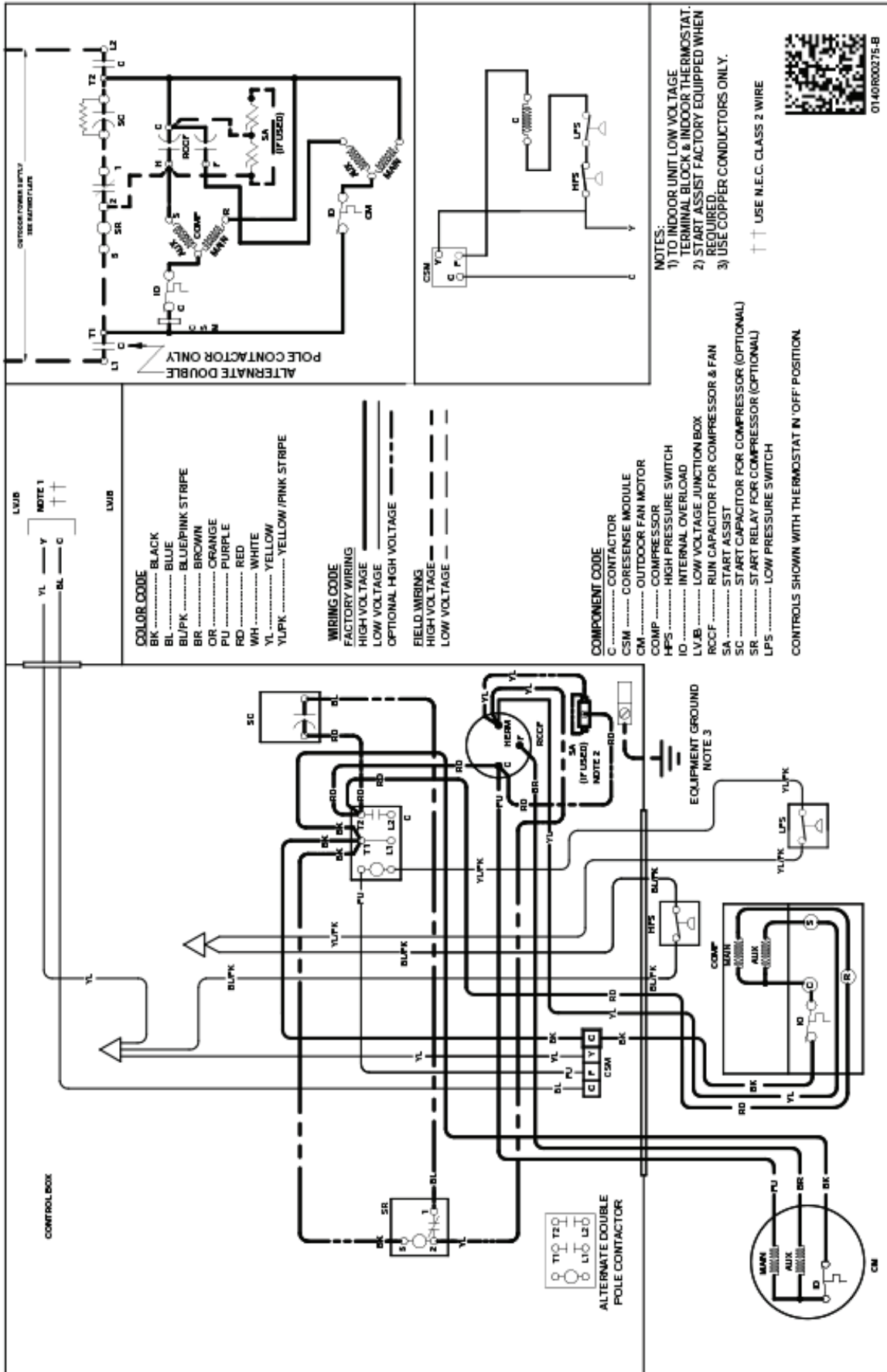

Wiring is subject to change. Always refer to the wiring diagram on the unit for the most up-to-date wiring.

WARNING

HIGH VOLTAGE!
 DISCONNECT ALL POWER BEFORE SERVICING OR INSTALLING THIS UNIT.
 MULTIPLE POWER SOURCES MAY BE PRESENT. FAILURE TO DO SO MAY
 CAUSE PROPERTY DAMAGE, PERSONAL INJURY OR DEATH.

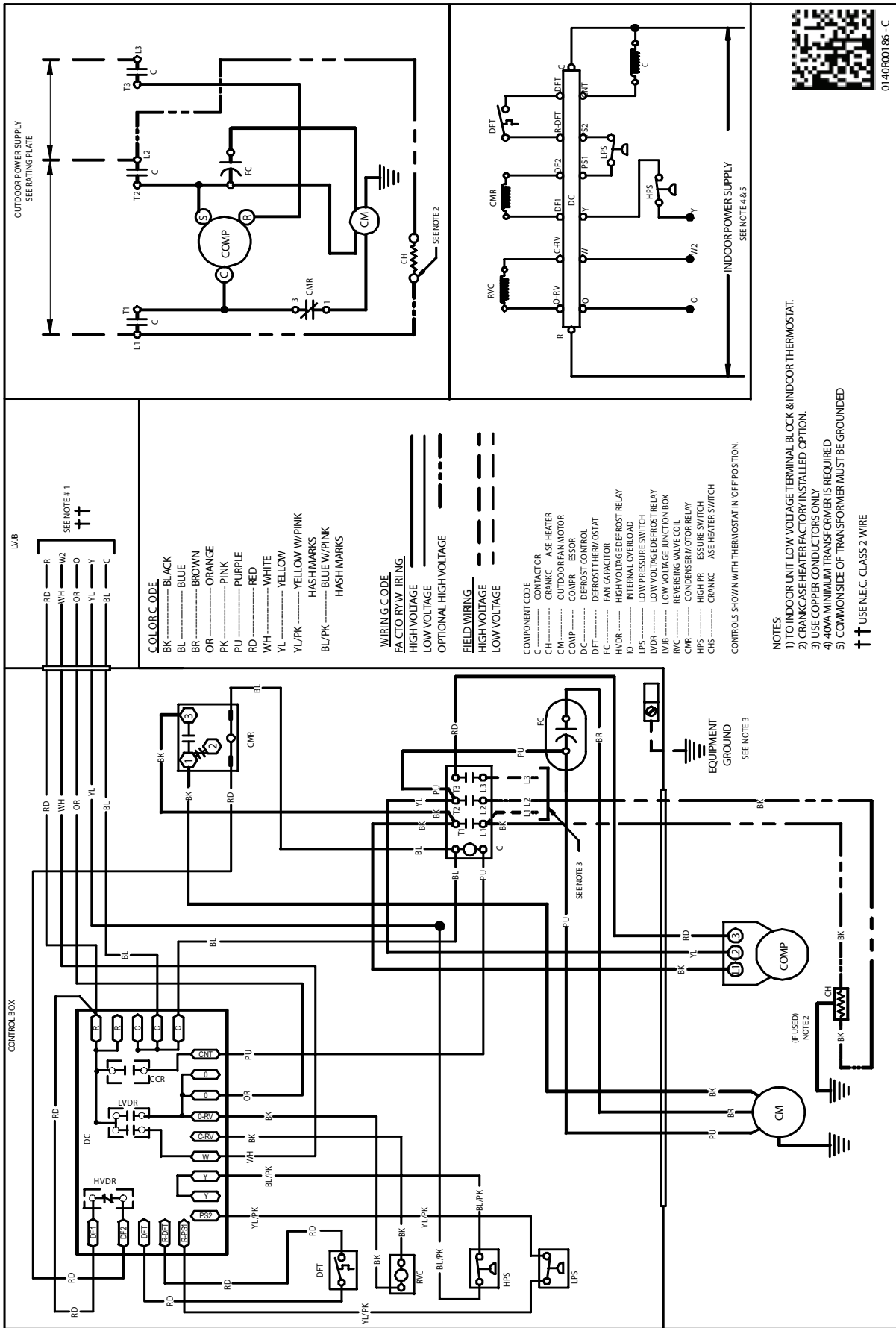

LV/B **SEE NOTE # 1**

RD R
WH W2
OR O
YL Y
BL C

COLOR CODE
 BK BLACK
 BL BLUE
 BR BROWN
 OR ORANGE
 PK PINK
 PU PURPLE
 RD RED
 WH WHITE
 YL YELLOW
 YL/PK YELLOW W/PINK
 HASH MARKS
 BL/PK BLUE W/PINK
 HASH MARKS

WIRING CODE
 FACTORY WIRING
 HIGH VOLTAGE
 LOW VOLTAGE
 OPTIONAL HIGH VOLTAGE

FIELD WIRING
 HIGH VOLTAGE
 LOW VOLTAGE

COMPONENT CODE
 C CONTACTOR
 CH CRANK CASE HEATER
 CM COMPRESSOR MOTOR
 COMP COMPRESSOR
 DC DEFROST CONTROL
 DFT DEFROST THERMOSTAT
 FC FAN CAPACITOR
 HDR HIGH VOLTAGE DEFROST RELAY
 ICF INTERNAL OVERLOAD
 LPS LOW VOLTAGE DEFROST RELAY
 LV/B LOW VOLTAGE DEFROST RELAY BOX
 RVC REVERSING VALVE COIL
 CMR CONDENSER MOTOR RELAY
 HPS HIGH PRESSURE SWITCH
 CHS CRANK CASE HEATER SWITCH

CONTROLS SHOWN WITH THERMOSTAT IN OFF POSITION.

0140R001 86 - C

NOTES:
 1) TO INDOOR UNIT LOW VOLTAGE TERMINAL BLOCK & INDOOR THERMOSTAT.
 2) CRANK CASE HEATER FACTORY INSTALLED OPTION.
 3) USE COPPER CONDUCTORS ONLY
 4) 40VA MINIMUM TRANSFORMER IS REQUIRED
 5) COMMON SIDE OF TRANSFORMER MUST BE GROUNDED

†† USE N.E.C. CLASS 2 WIRE

Wiring is subject to change. Always refer to the wiring diagram on the unit for the most up-to-date wiring.

WIRING DIAGRAMS

GSZ130181A[D/F/G], GSZ130241[B*/C*], GSZ130421A[G/H],
 GSZ130301A[E/F/G/H], GSZ130361B*, GSZ140[18-30/48-60]1AA,
 GSZ140[36-42]1AB, GSZ130181AC, GSZ130241BB, GSZ130301AD
 GSZ130361B*, GSZ130421A*, GSZ130481AC, GSZ130601AC



WARNING
HIGH VOLTAGE!
 DISCONNECT ALL POWER BEFORE SERVICING OR INSTALLING THIS UNIT.
 MULTIPLE POWER SOURCES MAY BE PRESENT. FAILURE TO DO SO MAY
 CAUSE PROPERTY DAMAGE, PERSONAL INJURY OR DEATH.

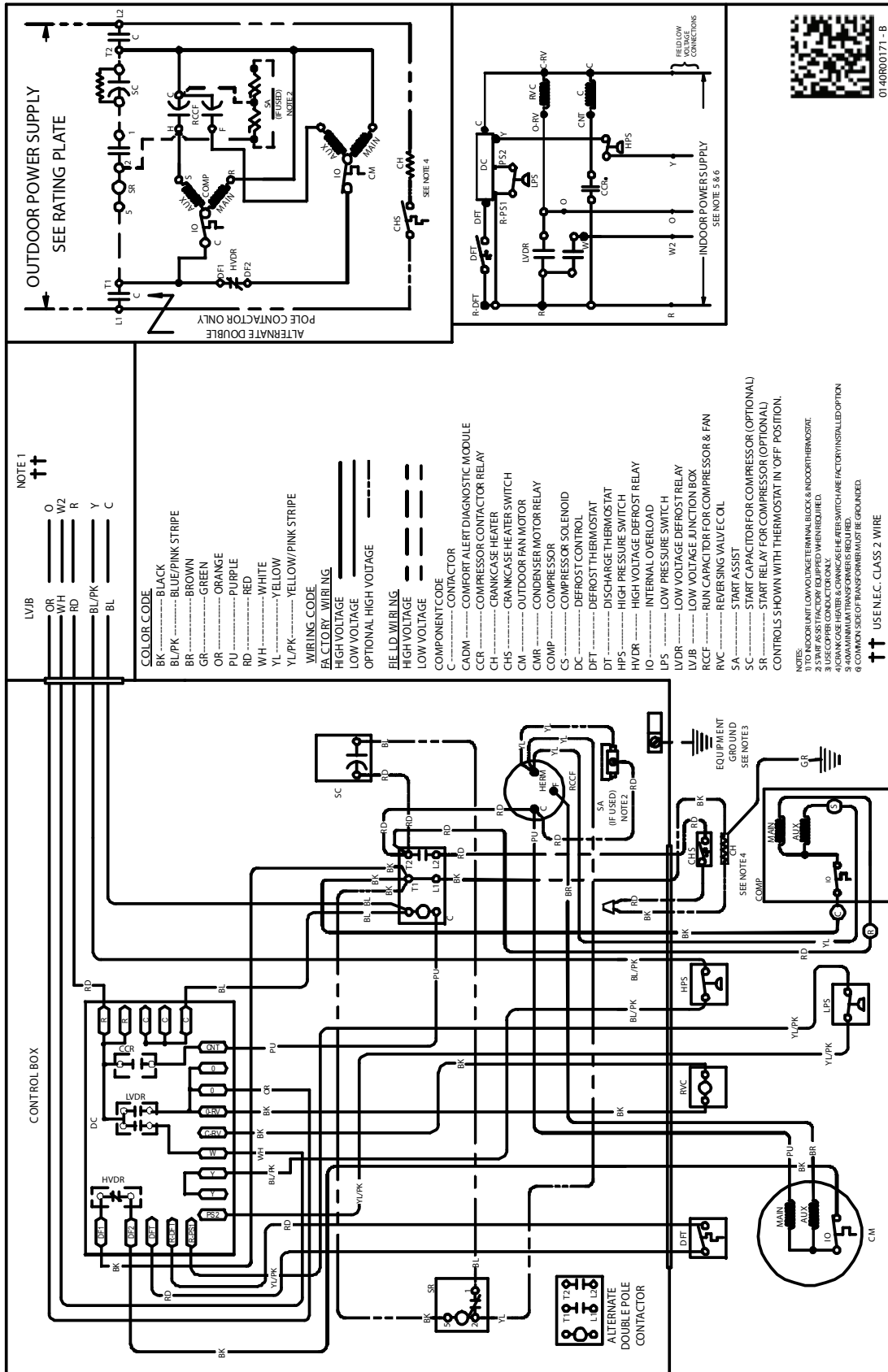

0140R00171-B

Wiring is subject to change. Always refer to the wiring diagram on the unit for the most up-to-date wiring.



WARNING

HIGH VOLTAGE!

DISCONNECT ALL POWER BEFORE SERVICING OR INSTALLING THIS UNIT.
MULTIPLE POWER SOURCES MAY BE PRESENT. FAILURE TO DO SO MAY
CAUSE PROPERTY DAMAGE, PERSONAL INJURY OR DEATH.

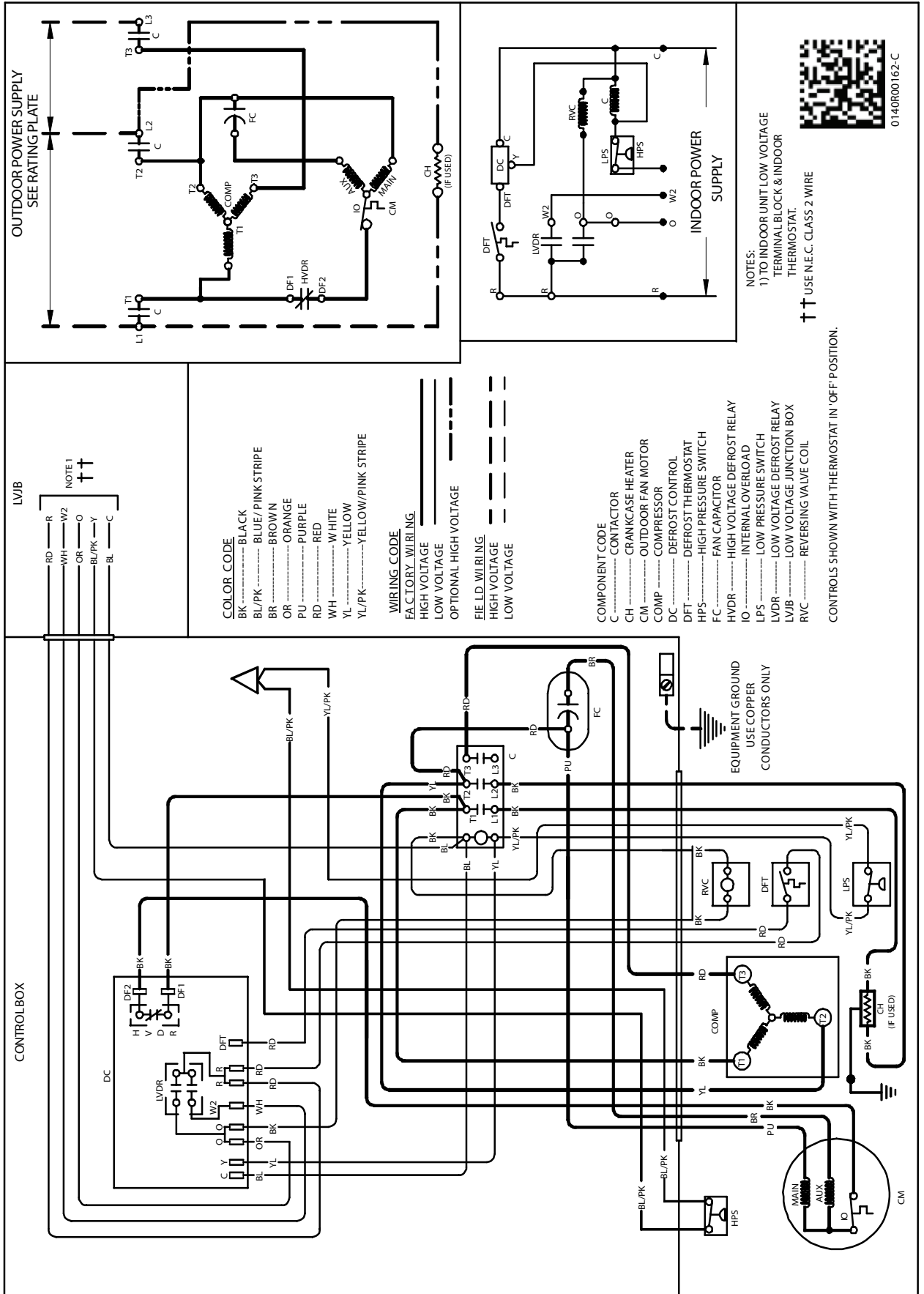

0140R00162-C

Wiring is subject to change. Always refer to the wiring diagram on the unit for the most up-to-date wiring.



WARNING
HIGH VOLTAGE!
 DISCONNECT ALL POWER BEFORE SERVICING OR INSTALLING THIS UNIT.
 MULTIPLE POWER SOURCES MAY BE PRESENT. FAILURE TO DO SO MAY
 CAUSE PROPERTY DAMAGE, PERSONAL INJURY OR DEATH.

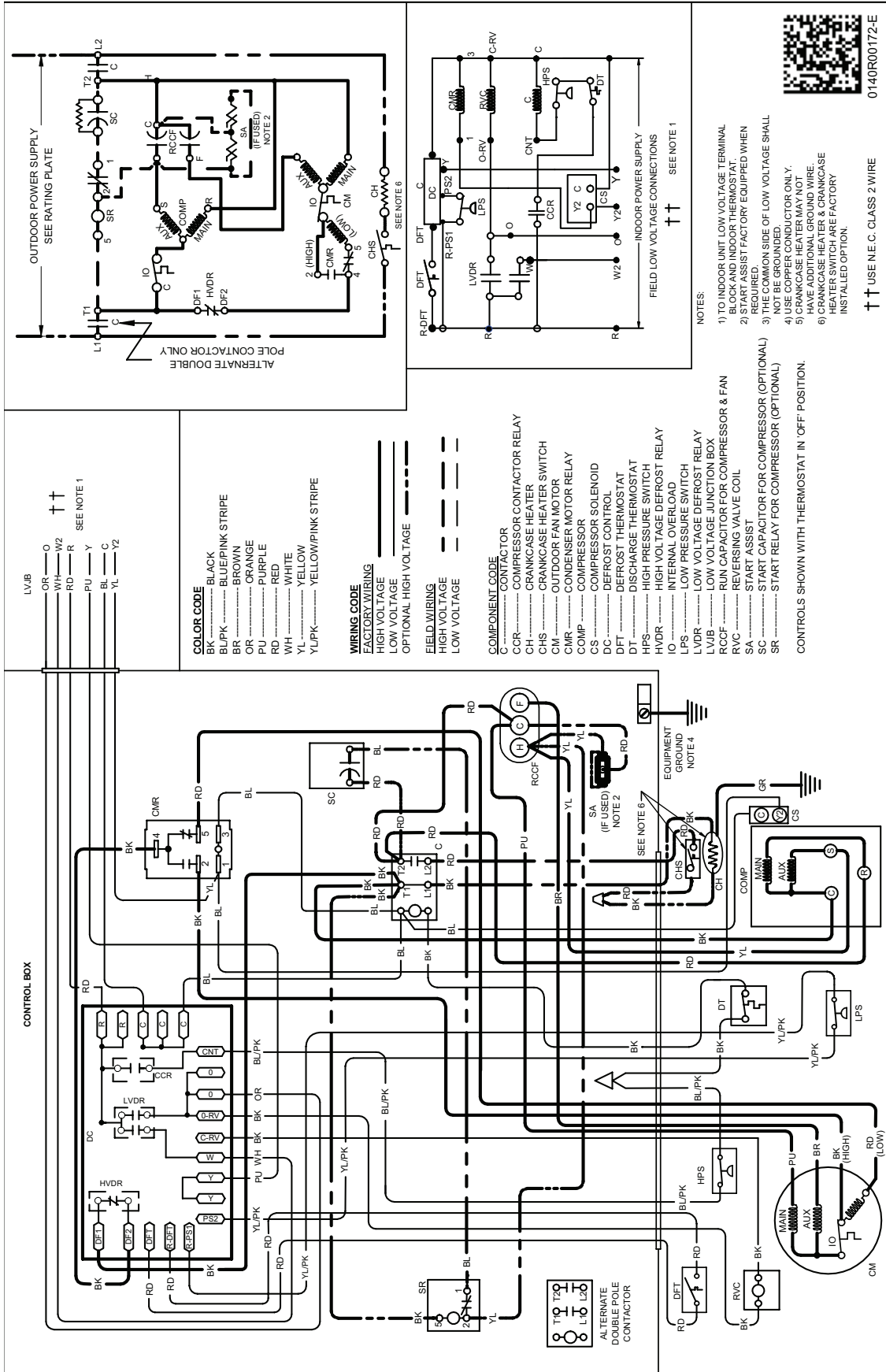

Wiring is subject to change. Always refer to the wiring diagram on the unit for the most up-to-date wiring.



WARNING
HIGH VOLTAGE!
 DISCONNECT ALL POWER BEFORE SERVICING OR INSTALLING THIS UNIT.
 MULTIPLE POWER SOURCES MAY BE PRESENT. FAILURE TO DO SO MAY
 CAUSE PROPERTY DAMAGE, PERSONAL INJURY OR DEATH.

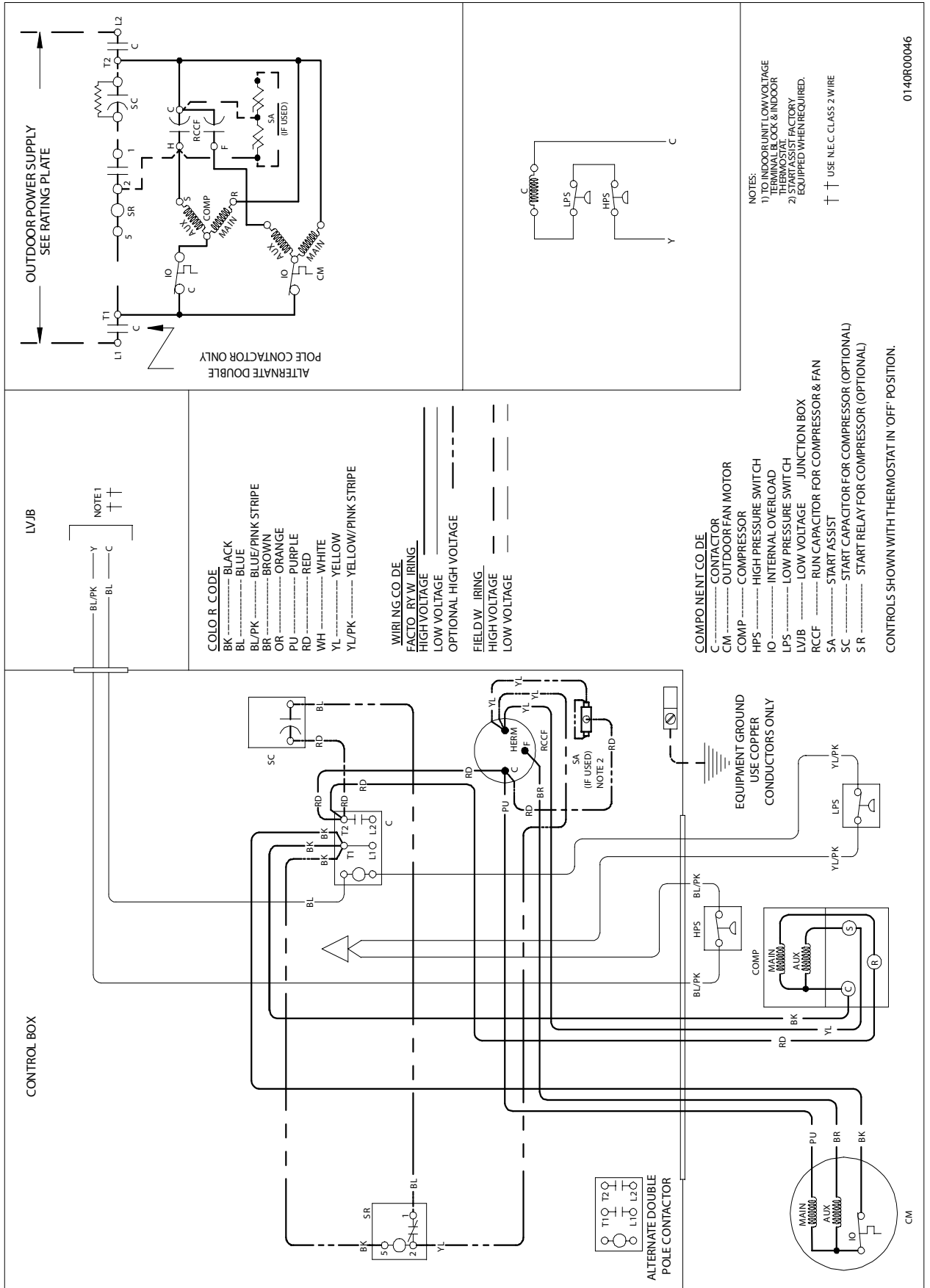

OUTDOOR POWER SUPPLY
 SEE RATING PLATE

ALTERNATE DOUBLE
 POLE CONTACTOR ONLY

LVJB

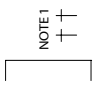

NOTE 1
 † †

- COLOR CODE**
- BK ----- BLACK
 - BL ----- BLUE
 - BL/PK ----- BLUE/PINK STRIPE
 - BR ----- BROWN
 - OR ----- ORANGE
 - PU ----- PURPLE
 - RD ----- RED
 - WH ----- WHITE
 - YL ----- YELLOW
 - YL/PK ----- YELLOW/PINK STRIPE

- WIRING CODE**
- FACTORY WIRING -----
 - HIGH VOLTAGE -----
 - LOW VOLTAGE -----
 - OPTIONAL HIGH VOLTAGE -----
- FIELD WIRING**
- HIGH VOLTAGE -----
 - LOW VOLTAGE -----

- COMPONENT CODE**
- C ----- CONTACTOR
 - CM ----- OUTDOOR FAN MOTOR
 - COMP ----- COMPRESSOR
 - HPS ----- HIGH PRESSURE SWITCH
 - IO ----- INTERNAL OVERLOAD
 - LPS ----- LOW PRESSURE SWITCH
 - LVJB ----- LOW VOLTAGE JUNCTION BOX
 - RCCF ----- RUN CAPACITOR FOR COMPRESSOR & FAN
 - SA ----- START ASSIST
 - SC ----- START CAPACITOR FOR COMPRESSOR (OPTIONAL)
 - SR ----- START RELAY FOR COMPRESSOR (OPTIONAL)

CONTROLS SHOWN WITH THERMOSTAT IN 'OFF' POSITION.

- NOTES:**
- 1) TO INDOOR UNIT, LOW VOLTAGE THERMOSTAT, LOCK & INDOOR THERMOSTAT
 - 2) START ASSIST FACTORY EQUIPPED WHEN REQUIRED.

† † USE N.E.C. CLASS 2 WIRE

0140R00046

WIRING DIAGRAMS

SSZ160[24]1AG, SSZ160[36-48]1AE, SSZ160[24]1AA-AF, SSZ160[36-48]1AA-AD



WARNING

HIGH VOLTAGE!
DISCONNECT ALL POWER BEFORE SERVICING OR INSTALLING THIS UNIT.
MULTIPLE POWER SOURCES MAY BE PRESENT. FAILURE TO DO SO MAY
CAUSE PROPERTY DAMAGE, PERSONAL INJURY OR DEATH.

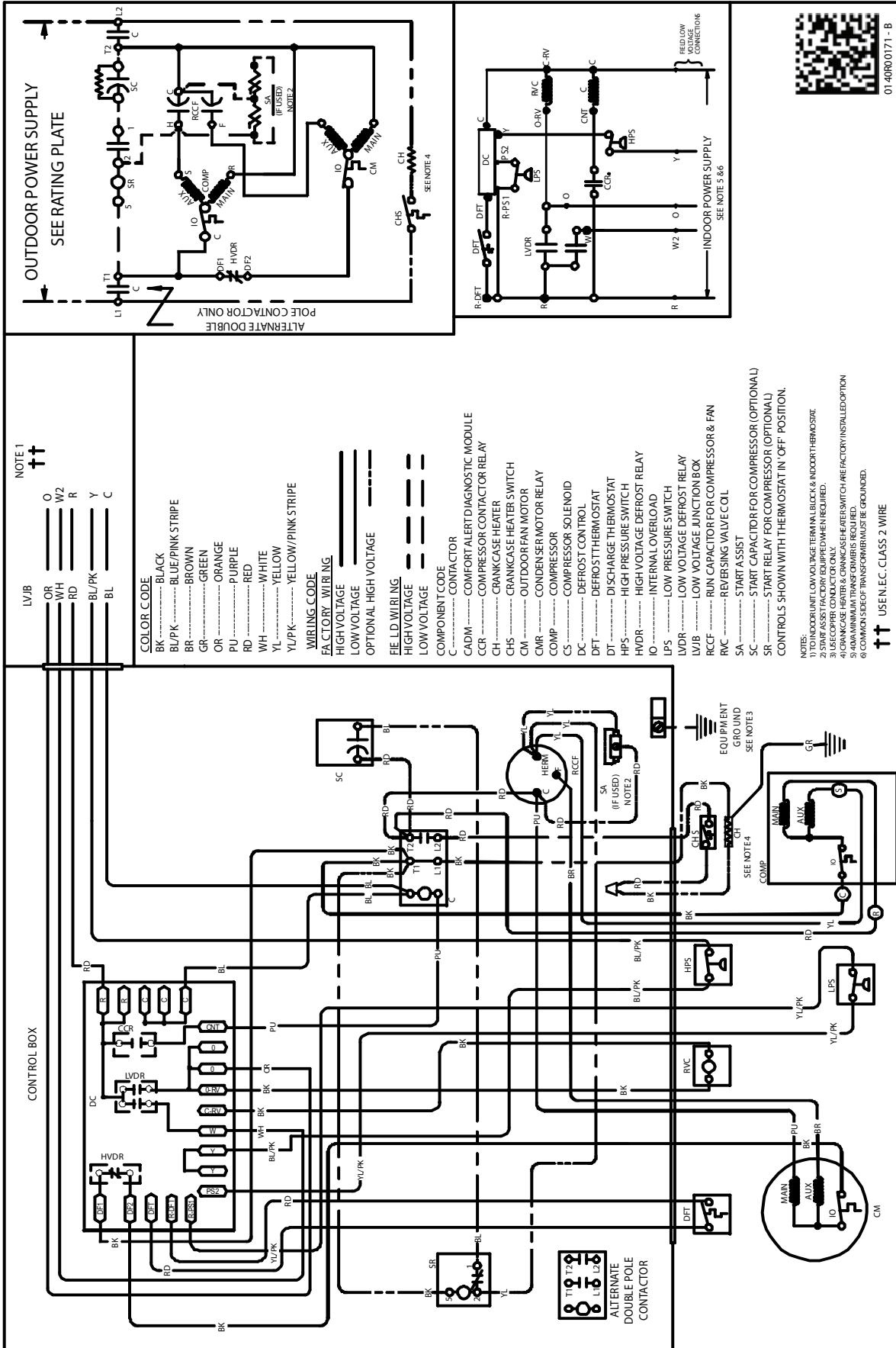

01 40R00171 - B

Wiring is subject to change. Always refer to the wiring diagram on the unit for the most up-to-date wiring.

WIRING DIAGRAMS

VSX130[18-48/61]1A* / VSX130{24/36/42-60}1B*/1D*,
 VSX130[30]1D*/VSX130[36]1E* / VSX140[18-60]1A*/VSX130[18-48/61]1A*
 VSX130[24/36/42-60]1B*/1D*/VSX130[30]1D* / VSX130[36]1E*



WARNING
HIGH VOLTAGE!
 DISCONNECT ALL POWER BEFORE SERVICING OR INSTALLING THIS UNIT.
 MULTIPLE POWER SOURCES MAY BE PRESENT. FAILURE TO DO SO MAY
 CAUSE PROPERTY DAMAGE, PERSONAL INJURY OR DEATH.

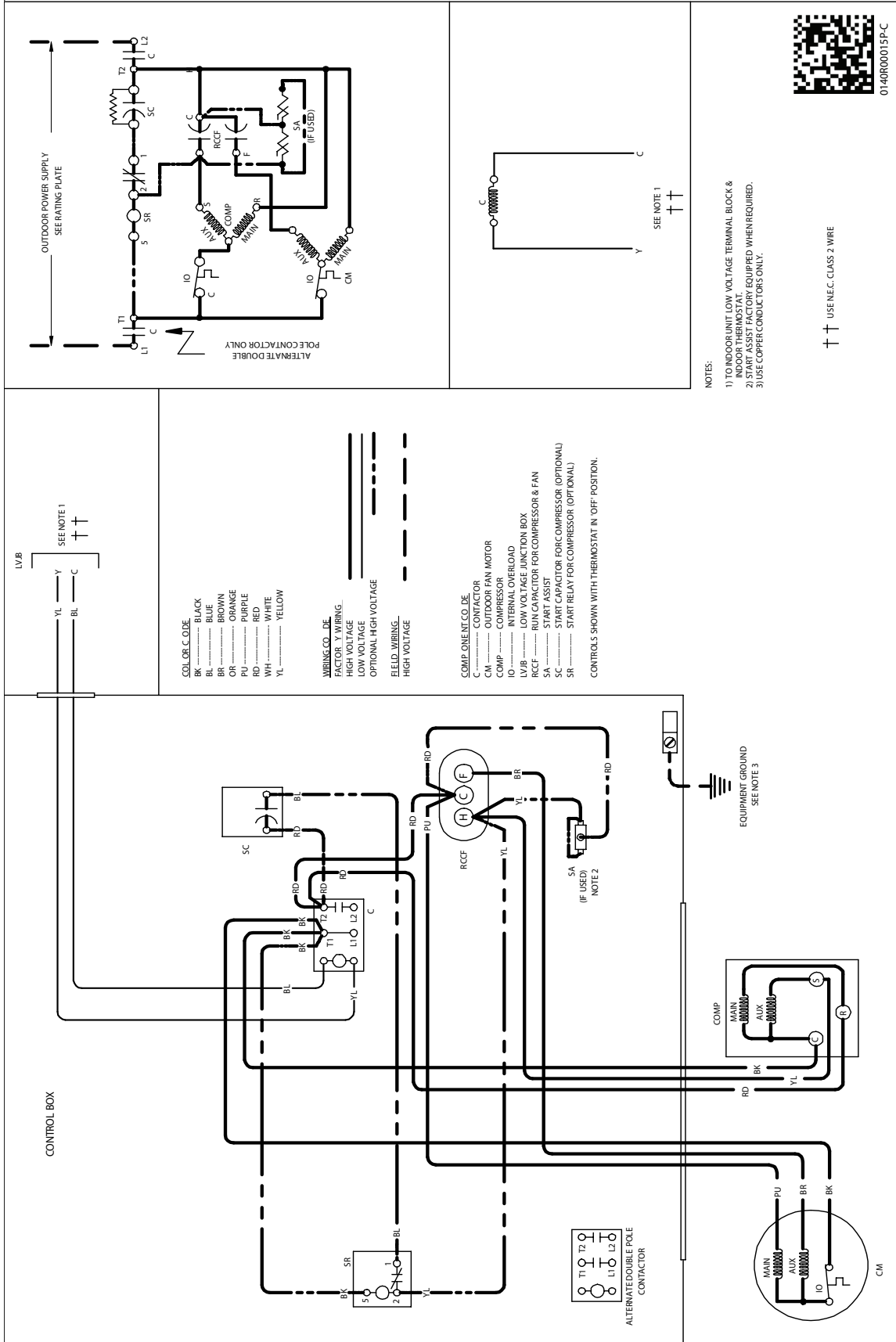

Wiring is subject to change. Always refer to the wiring diagram on the unit for the most up-to-date wiring.



WARNING
HIGH VOLTAGE!
 DISCONNECT ALL POWER BEFORE SERVICING OR INSTALLING THIS UNIT.
 MULTIPLE POWER SOURCES MAY BE PRESENT. FAILURE TO DO SO MAY
 CAUSE PROPERTY DAMAGE, PERSONAL INJURY OR DEATH.

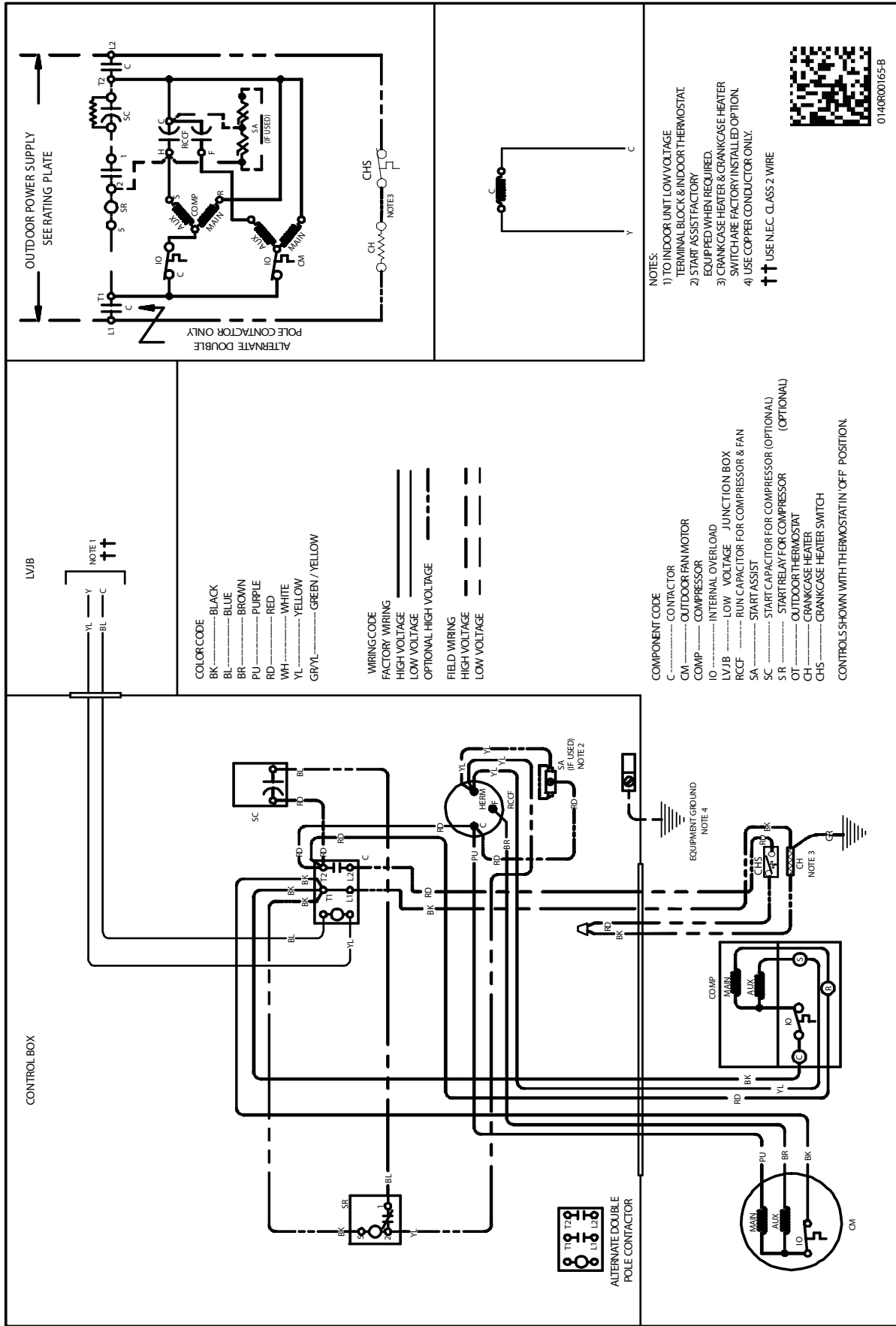

0140R00165-B

Wiring is subject to change. Always refer to the wiring diagram on the unit for the most up-to-date wiring.

WARNING

HIGH VOLTAGE!
 DISCONNECT ALL POWER BEFORE SERVICING OR INSTALLING THIS UNIT.
 MULTIPLE POWER SOURCES MAY BE PRESENT. FAILURE TO DO SO MAY
 CAUSE PROPERTY DAMAGE, PERSONAL INJURY OR DEATH.

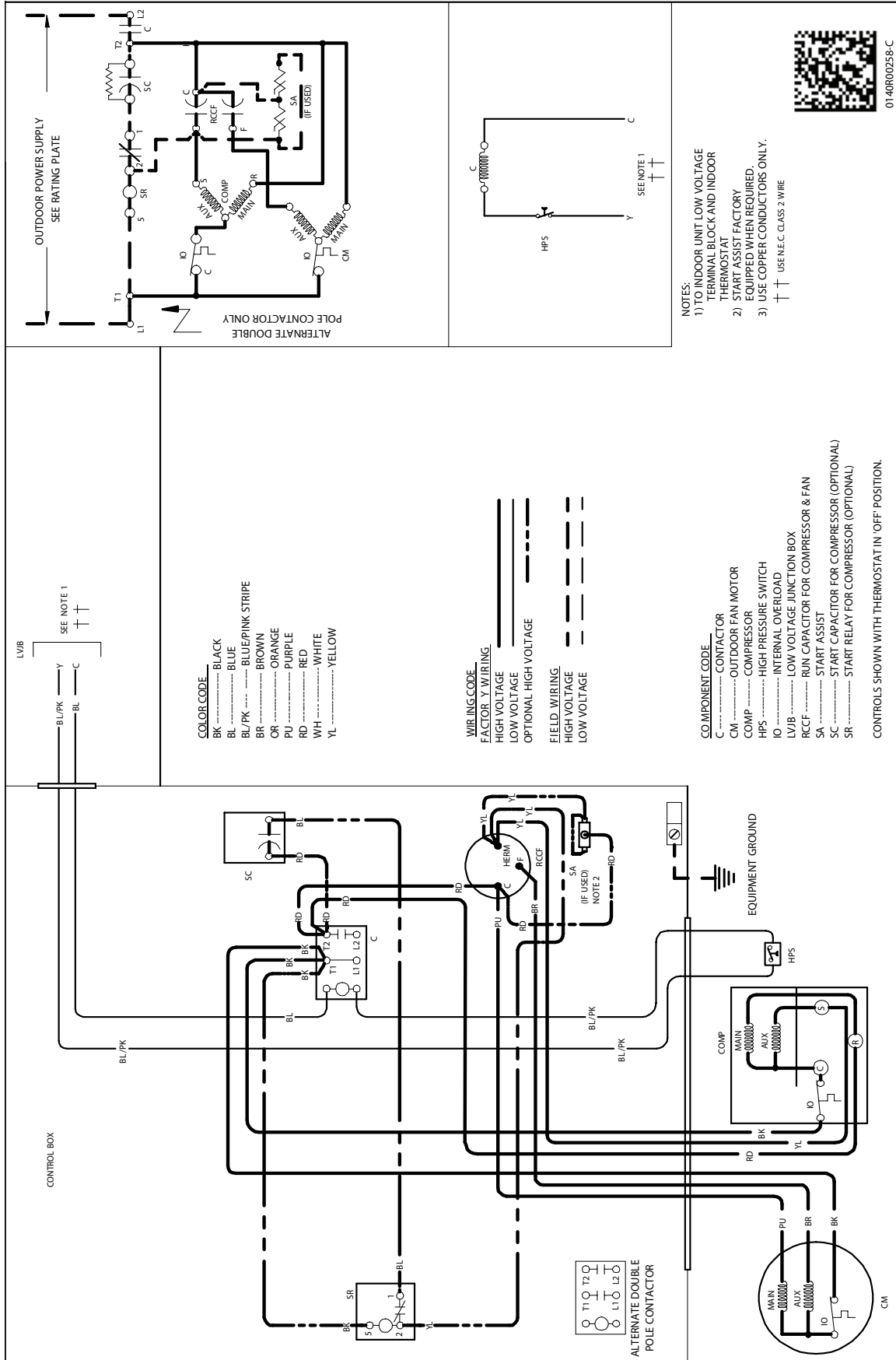

WIRING DIAGRAMS

VSZ130181A[C/D/E/F], VSZ130241B[B/C/D], VSZ130301A[D/E/F/G],
VSZ130361B[B/C/D], VSZ130421A[C/D/E/F/G], VSZ130481A[C/D],
VSZ130601AC



WARNING
HIGH VOLTAGE!
DISCONNECT ALL POWER BEFORE SERVICING OR INSTALLING THIS UNIT.
MULTIPLE POWER SOURCES MAY BE PRESENT. FAILURE TO DO SO MAY
CAUSE PROPERTY DAMAGE, PERSONAL INJURY OR DEATH.

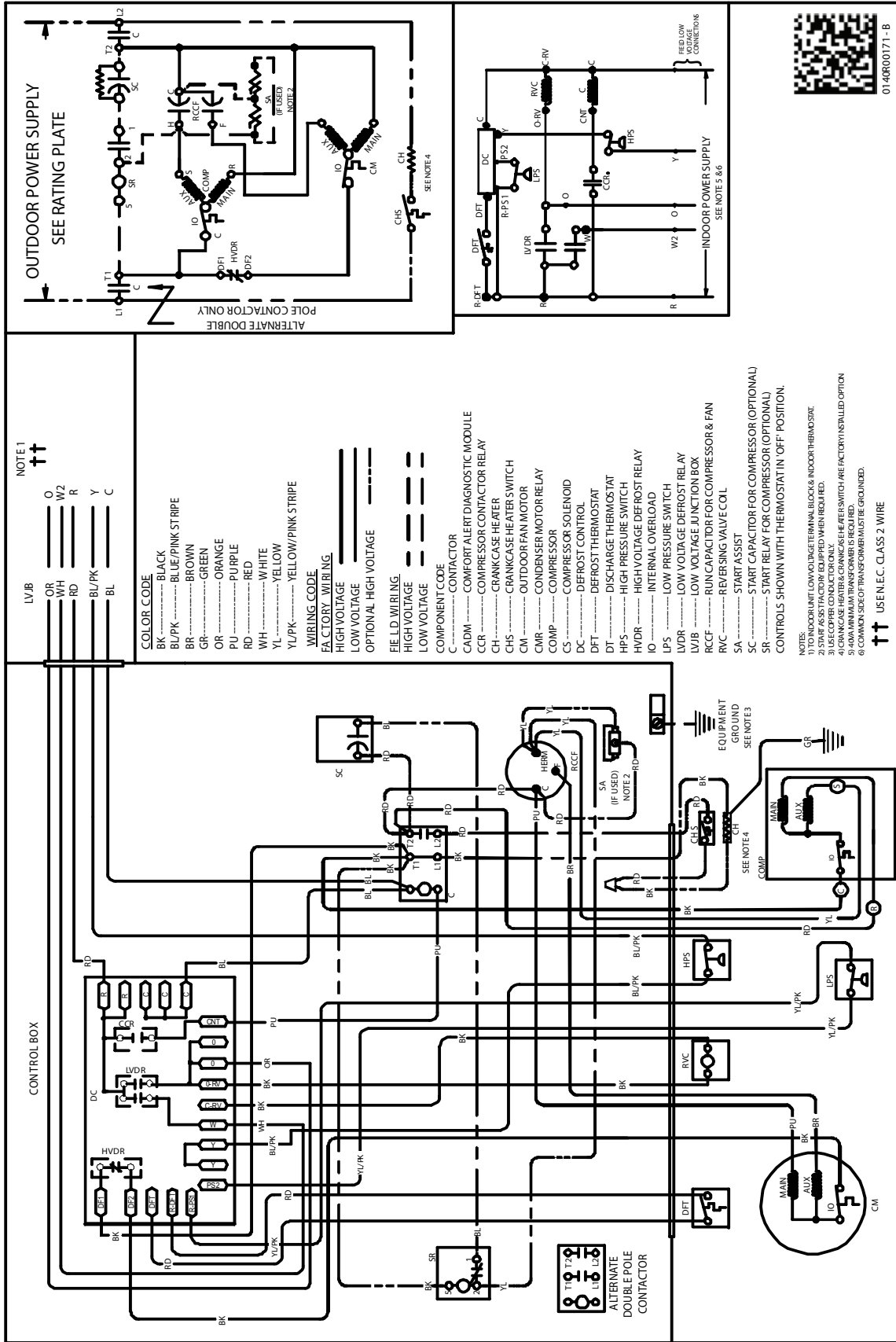

Wiring is subject to change. Always refer to the wiring diagram on the unit for the most up-to-date wiring.